

Deliverable title: Report from final meetings in the six river basins

Deliverable number: D7.7

Work Package number: WP7

Due month: M26 postponed to M28

Delivery month: M30

Dissemination level: Public

Lead beneficiary: Aarhus University (AU)

Beneficiaries: All partners in NORDBALT-ECOSAFE



NORDBALT ECOSAFE

Invitation to 2nd round of REGIONAL STAKEHOLDER MEETINGS with presentation and discussion of project results

The EU project named **NORDBALT-ECOSAFE** focuses on a region in Europe that offers ideal conditions for developing an innovative methodologies to set safe ecological boundaries for nutrients, to use sensors to measure nutrients as well as to quantify nitrogen (N) and phosphorus (P) sources and pathways and efficiently reduce nutrient emissions with due attention to safeguarding GHG emissions and utilizing advanced governance structures in the different regions. The project is a coordinate or support research action that includes activities and policies (networking, exchanges, access to research infrastructures, studies, conferences, etc.) that are intended to support the policies of the EU Agencies for future environmental planning.

The **NORDBALT-ECOSAFE** consortium consists of eight institutes and is developing and demonstrating innovative methods and establish best practices to improve current river basin management and governance by reaching the following major aims:

- i) Setting ecologically safe nutrient boundaries in different types of water bodies.
- ii) Improving monitoring of nutrient concentrations by comparing benefits of novel high-frequency online sensors with traditional monitoring.
- iii) Establishing nutrient loading tipping points for carbon sequestration and emissions in water bodies.
- iv) Establishing a harmonized river basin modelling tool for precise estimation of nutrient sources, pathways and transport.
- v) Demonstrating novel Nature Based Solutions (NBSs) and Mitigation Measures (MMs) for reaching the required nutrient load reductions.
- vi) Developing advanced solutions supporting regional governance structures to implement the most suitable measures to meet the ecological nutrient boundaries.

The overarching aim of **NORDBALT-ECOSAFE** is to ensure that N and P concentrations and loadings in water bodies in the Nordic-Baltic region are reduced and will remain within safe ecological boundaries in the different regional water bodies such as streams, rivers, lakes, and coastal waters.

The project has seven work packages (Figure 1) and our homepage where all our deliverables can be found is: <https://projects.au.dk/nordbalt-ecosafe>.

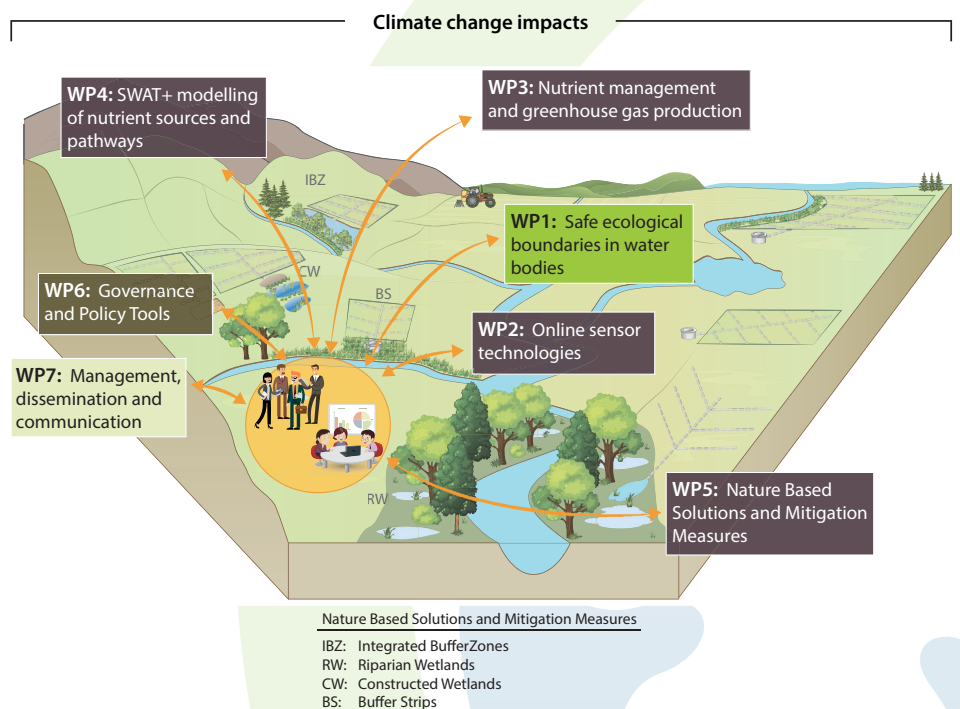

Figure 1: NORDBALT-ECOSAFE work packages.

One important part of the project is to reach out to regional and national stakeholders at regional meetings in the six catchments investigated in the project (Figure 2).

The project has developed the following key deliverables to be shared with you as stakeholders at the upcoming regional meeting:

1. Reference values as well as safe ecological boundaries (G/M) for river and lake types in the Nordic (WP1).
2. Fact sheets for use of sensors in regional/national monitoring programs.
3. Application of SWAT+ on the river basin and comparison of outcome regarding nutrient loss and loadings to national methodologies.
4. A classification framework and factsheets for Nature based Solutions (NbS) and mitigation measures (MM) for reducing nutrient losses from agricultural land.
5. A timeline of policy and water quality changes with examples of governance tools.

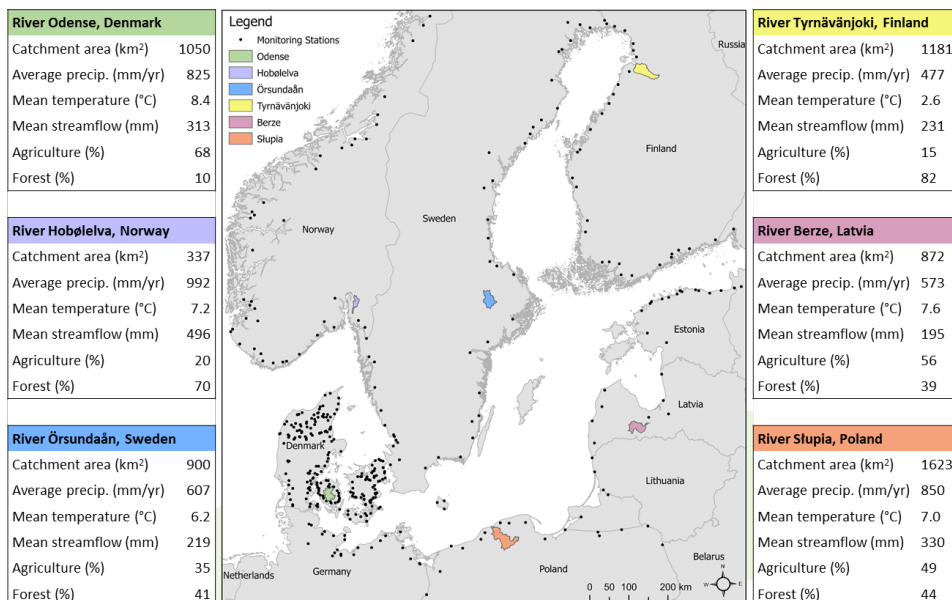

Figure 2. The six catchments that is central for the projects work and outputs.

NORDBALT-ECOSAFE is inviting you to attend the regional stakeholder meeting in your river basin for discussion of project outcomes and their possible use in your situation. The in-person meetings will take place in November 2024. The possibility to attend online via Teams will be provided. The invitations for the meetings will be sent around by the local organizers in early autumn of 2024.

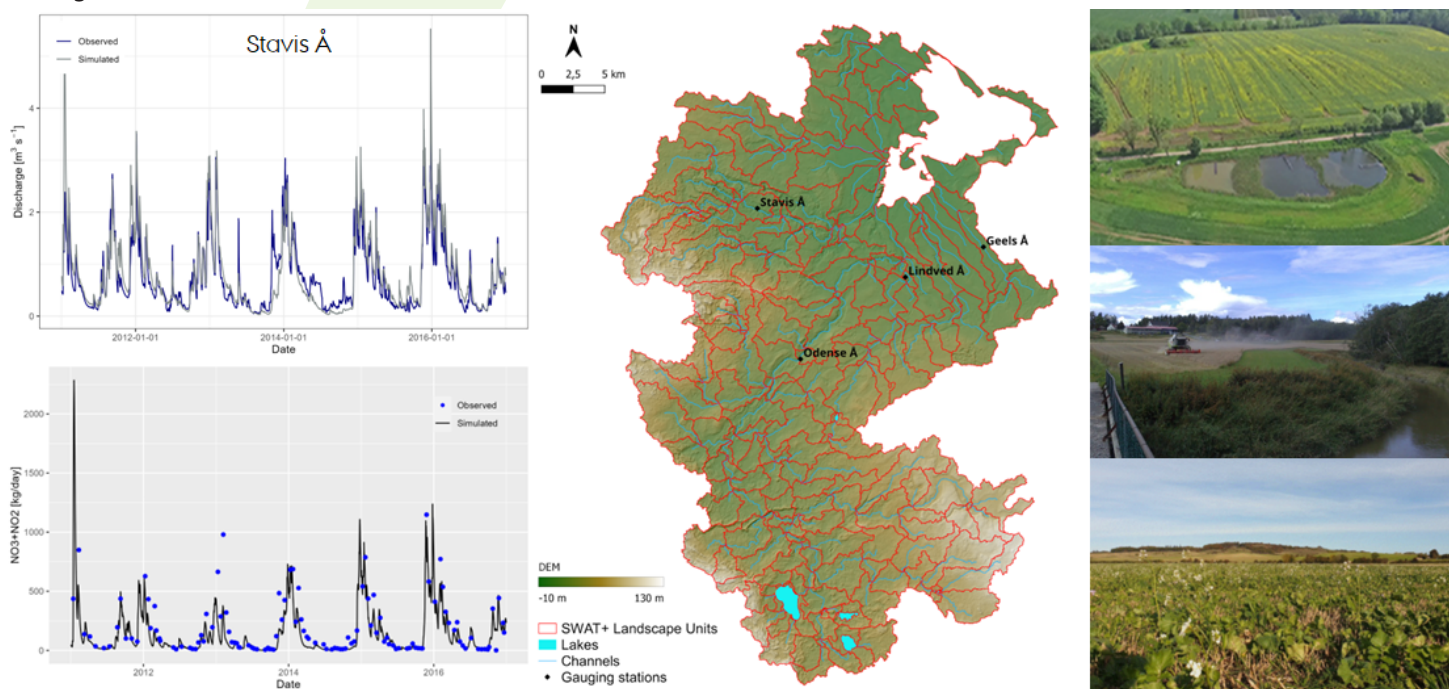

Figure 3. Example of a SWAT+ application to a river basin with selected NbSs and MMs to be applied in the scenario analysis (river Odense, Denmark).

The draft agenda for the meetings will be:

1. Welcome from the coordinator of NORDBALT-ECOSAFE – Professor Brian Kronvang, Department of Ecoscience, Aarhus University, Denmark.
2. A round table introduction of the participants at the meeting.
3. Presentation and discussion of safe ecological boundaries and sensor monitoring followed by a short round of Mentimeter questions (WP1 and WP2).
4. Lunch break.
5. Presentation of SWAT+ modelling and NbS and MM scenarios to be modelled in the river basin and discussion of their relevance to stakeholders (WP4 and WP5).
6. Presentation of timelines of policy and water quality changes and of governance tools (WP6).
7. Summing up and end of meeting.

Regional meeting in Coastal Water Board, River Odense, Denmark with NORDBALT-ECOSAFE project since first regional meeting in January 2023

The NORDBALT-ECOSAFE assisted the Coastal Water Board, River Odense Basin, Denmark in drafting a report 'Analysis and recommendations for the road to achieve the objectives set for Odense Estuary – Odense Coastal Water Board suggestions to project about local founded analysis' with emphasis on utilizing the SWAT+ model for detailed scenarios as the model has been calibrated and validated under the EU project (see attached final report where the modeling part is page 91-110). The modeling team from AU lead by Katrin Bieger took part in several Coastal Water Board meetings during 2023 with interactions with stakeholders coming from local municipalities, water works, Nature Organizations, Agricultural Organizations, etc (See Annex A for a listing of institutions).

In total three scenarios were conducted with SWAT+:

1. Conversion of all cropland to extensive grassland.
2. Conversion of all land uses except for urban land within the floodplain delineated by QSWAT+ to wetlands.
3. A combination of 1. and 2., where all cropland in the upland areas of the catchment are converted to grassland and all land uses except for urban land within the floodplain are converted to wetlands.

At the meetings interactive participation in the selection of potential wetland areas was conducted with the participation of the local municipalities in a four step procedure:

Step 1: Delineation of floodplains, which are the most suitable areas of a catchment for restoring wetlands, using the SWAT+ interface

Step 2: Exclusion of urban areas as they are unsuitable for wetland restoration

Step 3: Review of map during a workshop with Coastal Water Board and Odense Fjord Samarbejdet on the 9th of October 2023 in Odense, DK and exclusion of additional areas that are unsuitable for wetland restoration due to local planning in the seven municipalities having areas in the River Odense catchment.

Step 4: Development of an optimistic and a conservative scenario based on workshop outcomes and already existing wetlands



Photo: Meeting on 9th October 2023 in Odense with modelers and stakeholders about reviewing maps for potential placement of wetlands in the river Odense Basin.

Since early 2024 the work in Coastal Water Board Odense has been on hold due to new negotiations in Denmark about the New Green Trepartite Agreement that was launched in June 2024 and finally approved in the Danish Parliament in November 2024.

List of stakeholders involved in the Coastal Water Board, Odense, Denmark

Samarbejdet har følgende parter:

- Danmarks Naturfredningsforening
- L&F Centrovic
- Vandcenter Syd
- Fjernvarme Fyn
- Odense Renovation
- Faaborg-Midtfyn Kommune
- Nordfyns Kommune
- Kerteminde Kommune
- Odense Kommune
- Odense Havn
- HJ Hansen
- Marius Pedersen
- Dansk Gartneri
- FFV Energi & Miljø
- Syddansk Universitet
- SEGES



ANALYSER OG
ANBEFALINGER TIL
ALTERNATIVE VEJE TIL
MÅLOPFYLDESE FOR
ODENSE FJORD

Kystvandrådet for Odense Fjords bidrag til projekt
om lokalt funderede analyser

INDHOLDSFORTEGNELSE

Konklusioner fra de tekniske undersøgelser og analyser af Kystvandrådet for Odense Fjords arbejde	3
Anbefalinger fra Kystvandrådet for Odense Fjord	7
Tilstandsbeskrivelse og systemforståelse for Odense Fjord (AP 1.1).....	8
Status description of Odense Fjord.....	8
Fjordmodel (AP 1.2)	22
Description of the Odense Fjord model complex.....	22
Modelvalidering (AP 1.3).....	27
Model validation.....	27
Fjordmodel og scenarieanalyser (AP 1.4 og 1.6).....	37
Model development and Scenario Analysis.....	37
Vurdering af marine virkemidler og omkostninger ved restaurering (AP 1.5 og AP 3.2).....	55
Marine mitigation tools in Odense fjord.....	55
Oplandsbeskrivelse og stoftransport ift. Odense Fjord (AP 2.1 og AP 2.2)	67
Characterization of Odense Fjord catchment. Technical note.....	67
Hotspotanalyse (AP 2.3)	79
Note regarding the hotspot-analysis of nutrient transport.....	79
Dataoverførsel til SWAT model (AP 2.6 – første del).....	87
Wastewater data transferred to Odense Fjord SWAT catchment model. Technical note.....	87
Oplandsmodellering og scenarier (AP 2.4 – 2.5 + 2.7 – 2.9 + 2.11).....	91
Modelling of nitrogen load reduction scenarios in the Odense Fjord Catchment using SWAT+	91
Spildevandsscenarier (AP 2.6 – anden del).....	111
Odense Fjord Kystvandråd - WWTP scenarios	111
Scenarier for reduktion af den diffuse fosfortilførsel.....	119
Scenarios for reducing diffuse phosphorus. Technical note.....	119
Virkemiddelsplacering (AP 2.10)	122
Measures for reducing nutrients – ID15 lists.....	122
Finansieringskilder og omkostninger ved kollektive virkemidler (AP 3.1 og 3.3)	126
Wetland subsidy schemes and costs for wetland implementation	126
Omkostninger ved målrettede markvirkemidler (AP 3.4).....	129
Economic consequences of nitrogen targets on the cultivation surface in the coastal water catchment area of Odense Fjord, Seden Strand	129
Validering af effekt af alternative virkemidler (AP 4.1).....	146
Nutrient retention and carbon storage in the collective mitigation tools - A review.	146

Vurdering af tidslig virkemiddeleffekt (AP 4.2)	169
The potential for constructed subsurface mini wetlands in the catchment of Odense Fjord. Technical note.	169
Customizing the instrument selector to handle seasonal variation	178

Konklusioner fra de tekniske undersøgelser og analyser af Kystvandrådet for Odense Fjords arbejde

Generelt

For at opnå god økologisk tilstand i Odense Fjord peger de tekniske undersøgelser og analyser udført i regi af Kystvandrådet for Odense Fjord på behov for to overordnede tiltag. Dels skal der ske betydelige reduktioner af næringsstoffer fra oplandet til fjorden, og dels er det derudover nødvendigt med marine restaureringstiltag i fjorden.

Fjordens følsomhed for næringsstoffer

Undersøgelser af fjordens følsomhed for næringsstoffer viser med baggrund i den opsatte fjordmodel, at:

- der er positiv effekt på fjordens tilstand ved reduktion af både kvælstof og fosfor.
- fjordens økosystem responderer mere positivt på kvælstofreduktioner i vækstsæsonen (fra starten af april til udgangen af oktober) end i vinterhalvåret.

Der er i arbejdet med at finde virkemidler i oplandet taget ovenstående viden i betragtning. I arbejdet med at reducere kvælstof fra oplandet er der taget udgangspunkt i vandområdeplanens mål om en 34% reduktion for Odense Fjord, suppleret med et ønske om også at reducere fosfortabet til fjorden. Der er i oplandsarbejdet lagt særligt vægt på at finde 34% kvælstofreduktion i vækstsæsonen, da det er en afgørende forudsætning for at opnå god tilstand.

Valg af virkemidler i oplandet

Med henblik på at kvalificere valg af virkemidler i oplandet, er der af Aarhus Universitet og SEGES Innovation opsat en oplandsmodel (SWAT+) til at regne på kvælstoftransporter fra alle relevante kilder, herunder landbrug og spildevand. Der er gennemført følsomhedsscenarier (ekstremscenarier) for at teste potentialet for virkemidler.

Resultatet af disse scenarier er, at det har omtrent samme effekt på kvælstofreduktionen at udlægge alle ådale som vådområder, som at omlægge alt landbrug til ekstensivt græs. Konklusionerne er forelagt Kystvandrådet, og der var her et ønske om at gå videre med undersøgelse af potentiale for vådområder. Dels ud fra en betragtning om multifunktionalitet ved vådområder (klima, natur, biodiversitet mv.), samt at omkostningerne ved at udtage vådområder er mindre end at braklægge landbrugsjord uden for ådalene.

Der er på den baggrund foretaget et arbejde for at kvalificere potentialet for vådområder. Herunder blev oplandskommuner, kystvandråd og Odense Fjord Samarbejdets oplandsgruppe involveret med henblik på at maksimere anvendelsen af vådområder under hensyntagen til relevante lokale forhold. Dette er blandt andet sket i forbindelse med workshop og opfølgning.

Herudover er der af SEGES Innovation foretaget en kvalificering om brugen af drænvirkemidler med vægt lagt på minivådområder.

Der er af Aarhus Universitet foretaget en vurdering af muligheden for reduktion af diffus fosfor. Valg af fosforvirkemidler er ligeledes foretaget i en dialog med Kystvandrådet og Odense Fjord Samarbejdets oplandsgruppe. Det er her prioriteret, at der så vidt muligt laves tiltag til reduktion af fosfor, når der anlægges vådområder (P-ådale), og som minimum på 10 % af de vådområder som anlægges, samt at der plantes træer langs 10% af mindre og middelstore vandløb, som ligger uden for de områder, hvor der laves vådområder.

Renset spildevand udgør en relativ større andel af næringsstoffertilførslen i vækstsæsonen (fra starten af april til udgangen af oktober), hvor fjorden er mest følsom for næringsstoffer. Kvælstof fra punktkilder udgør i vækstsæsonen omkring 20-50% af den samlede udledning. I vintermånederne udgør punktkilder 10% eller mindre af den samlede tilførsel til fjorden. Dette er uddybet i afsnit om ”Oplandsbeskrivelse og stoftransport ift. Odense Fjord”. Der er af den grund blevet arbejdet med muligheder for yderligere at rense for fosfor og kvælstof til trods for, at de store renseanlæg i regi af VandCenterSyd allerede renses væsentligt under lovkrav.

Samlet set er der formuleret 3 scenarier for reduktioner fra oplandet til Odense Fjord:

- Scenarie 1 (S1): 6.700 ha nye vådområder
- Scenarie 2 (S2): Forbedret rensning af kvælstof og fosfor fra renseanlæg forår og sommer (fra starten af april til udgangen af september).*
- Scenarie 3 (S3): S1 + S2 + 127 minivådområder, samt tiltag mod at reducere fosfor**.

Note*: Udløb af koncentrationen af kvælstof og fosfor forbedres fra 3,32 mg/l TN og 0,22 mg/l TP til 3,0 mg/l TN og 0,2 mg/l TP.

Note**: Fosfortiltag omhandler at minimum 10% af vådområderne anlægges som fosfor-ådale. Plantning af træer på 10% af små og middel vandløb uden for vådområder.

De foreslåede tiltag fører til reduktioner, som for Scenarie 1 og Scenarie 3 overstiger årligt mål sat i Vandområdeplan 2021-2027, som er 34% kvælstofreduktion (tabel). Det ses af den månedlige fordeling på graf, at det har været muligt at opretholde en 34 % reduktion i sommermånederne i Scenarie 3 – dog ikke august som falder til under 30 % reduktion.

Scenarie 1 og Scenarie 3 fører også begge til målopfyldelse på klorofyl-a og vegetations dybdegrænse jf. målene i Vandområdeplan 2021-2027 for klorofyl og dybdegrænse (se afsnit om fjordmodel og scenarieanalyser).

	TN reduktion		TP reduktion	
	Ton	%	Ton	%
Scenarie 1	491	36	0,0	0
Scenarie 2	7	1	0,3	1
Scenarie 3	498	37	6,4	15

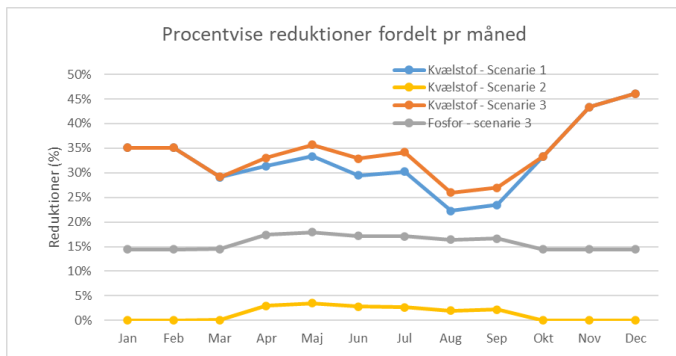

Effekt på fjorden ved næringsstofreduktioner

Effekten på fjordens tilstand ved de foreslåede oplandsscenarier (S1-S3) er beregnet af DHI med den opsatte fjordmodel. Resultaterne herfor viser, at man kan opnå de opsatte mål i Vandområdeplanerne for klorofyl og vegetationens dybdegrænse ved Scenarie 1 (vådområder) og Scenarie 3 (alle virkemidler).

Fjordmodelberegningerne viser også, at det har en effekt, at yderligere reducere næringsstoffer fra renseanlæg (scenarie 2), fordi reduktionerne sker forår og sommer, hvor fjorden er mest sensitiv for reduktioner, til trods for at spildevandsreduktionerne i mængde ikke er store. I Scenarie 2 og Scenarie 3 er kun medtaget spildevandsreduktioner, som kan gennemføres på den korte bane (få år), mens der er yderligere potentialer på den længere bane i forbindelse de aktiviteter VandCenterSyd planlægger at gennemføre. Reduktioner vil stadig være relativt små.

Marine restaureringstiltag

De tekniske og biologiske undersøgelser viser, at det er nødvendigt at foretage marine restaureringstiltag, hvis fjorden skal i god tilstand, udover at der skal ske reduktioner i næringsstoftilførslen. Der er dele af den ydre fjord, hvor næringsstofniveauet i dag er tilstrækkelig lavt til, at marin naturgenopretning kan igangsættes. Men det er i dag ikke muligt at foretage marin genopretning i store dele af fjorden pga. for høje tilførsler af næringsstoffer.

De faglige analyser viser, at genopretning bør starte i de dele af den ydre fjord, hvor næringsstofniveauet er tilstrækkeligt lavt. Efterhånden som næringsstoftilførslen falder, vil der blive mulighed for naturgenopretning i tilstødende områder i fjorden.

Analyserne ift. de marine virkemidler peger på, at følgende række af tiltag vil give de bedste muligheder for genopretning:

1. "Sandcapping" omkring Firtalsdæmningen og langs Egensedybets sydlige kystlinje. Evt. også ved bugterne omkring Klintebjerg.
2. Stenrev ved Enebærodde, Firtalsdæmningen og Bregnør.
3. Genopretninger af biogenerev (muslingebanker) – her kræves yderligere arbejde for at kvalificere lokaliteter.
4. Ålegræsgenopretning kan potentielt igangsættes ved området ved Bregnør og ved yderligere kvælstofreduktioner udvides restaurering til andre områder.
5. Genskabelse af tabte strandene – fx Lumby inddæmmede strand

Teknisk overordnet vurdering af gennemførelse

De foreslåede løsninger til næringsstofreduktioner i oplandet er alle kendte virkemidler, som i dag anvendes. Der er således ikke nogen tekniske forhindringer i gennemførelsen. Den største udfordring er skalaen.

Der skal etableres vådområder i så godt som alle ådale. Dette vil dels forde, at arbejdet med at etablere vådområder skal op i tempo, og dels kræver det stor opbakning fra lodsejere.

For arbejdet med etablering af vådområder er der i foråret 2023 igangsat en optimeret VOS (VandOplandsStyregruppe). Der er stor opbakning til et bredt og optimeret samarbejde blandt kommuner, landbrug mfl. omkring implementering af kollektive virkemidler.

Der er opbakning til denne indsats fra den fynske landboforening, og dette vurderes afgørende for at sikre det nødvendige medejerskab og lodsejeropbakning til udarbejdelsen og implementeringen af de lokale planer.

Der er desuden faktorer som ikke er medtaget i beregningerne, men som peger på øget sandsynlighed for at komme i mål med god tilstand:

- Siden perioden 2016-2018 er der sket et yderligere 20-30 % fald i sommerkoncentrationen (juni-aug.) af nitrat i de 4 største vandløb til fjorden og koncentrationen af nitrat i alle 4 vandløb er i dag under 1 mg/l i disse måneder. Dette er ikke sket vinter og forår, men fordi fjorden er særlig følsom for sommertilførsel, vil dette have positiv virkning for fjorden. Hvis faldet i sommermånederne er tilstrækkeligt til at kunne resultere i en effekt på de to indikatorer, forventes det at indgå i den næste statusopgørelse fra de statslige vandmyndigheder.
- VandCenterSyd har planlagt flere aktiviteter, som på længere sigt vil nedbringe tilførslen af rensat spildevand til fjorden. Herunder omlægning og nedlægning af mindre anlæg, samt reduktioner af uvedkommende vand i afløbssystemer.
- Den modelberegnete fjernelse i vådområder (fjernelse pr ha) er sat konservativt, og det vurderes sandsynligt, at man ved realisering kan opnå en større fjernelse end antaget i beregninger.
- Hotspotundersøgelse i delopland viser, at der er potentiale for at reducere næringsstoffer fra specifikke områder, som bidrager meget. Dette vil øge effektivitet ved placering af virkemidler.
- Der er ikke medregnet positiv feedback fra marine restaureringstiltag. Når ålegræs etableres i tilstrækkeligt omfang vil det have en betydelig filtereffekt i forhold til næringsstoffer. Positive feedback mekanismer indgår dog allerede i antagelserne bag fastlæggelse af målbelastninger til fjorden.

Samlet set vurderes planen mulig at opnå, men det er ikke muligt inden for tidsfristen for opnåelse af god økologisk tilstand i 2027. Etablering af vådområder tager erfaringsmæssigt flere år at gennemføre. Herudover kræver særligt den marine restaurering væsentlig finansiering, som der ikke findes i dag.

Anbefalinger fra Kystvandrådet for Odense Fjord

På baggrund af de tekniske analyser har Kystvandrådet for Odense Fjord udarbejdet nedenstående anbefalinger til den videre indsats ift. genopretning af god økologisk tilstand i Odense Fjord.

1. *Helhedsorienteret tilgang i oplandet*

Kystvandrådet anbefaler, at der for oplandet tages afsæt i en helhedsorienteret tilgang som beskrevet i scenarie 3. Scenariet indeholder, at der tages flere virkemidler i anvendelse med det formål at reducere udledningerne af både kvælstof og fosfor til Odense Fjord. Indsatserne indeholder etablering af vådområder – både minivådområder og større vådområder i hele oplandet til fjorden, øget rensning af spildevand, træplantning langs vandløb og fosfor-ådale.

2. *Multifunktionalitet i vådområder*

Kystvandrådet anbefaler, at vådområder i hele oplandet i Odense Fjord etableres med et multifunktionelt perspektiv. Konkret anbefaler kystvandrådet, at vådområderne tager hensyn til både reduktion af udledninger, biodiversitet, rekreative hensyn osv.

3. *Målrettet marin naturgenopretningsindsats*

Kystvandrådet anbefaler, at der igangsættes målrettet marin naturgenopretning i Odense Fjord snarest muligt. Den målrettede indsats skal i første omgang koncentreres omkring de områder af fjorden, hvor næringsstofniveauerne giver de bedste betingelser herfor. Konkret skal indsatsen bestå af både sandcapping, stenrev, muslingebanker, ålegræsudplantning og genskabelse af tabte strandenge. På sigt skal indsatsen udvides geografisk i fjorden i takt med, at næringsstofniveauerne i flere dele af fjorden falder.

4. *Statslig medfinansieringsmuligheder ift. storskala marin naturgenopretning*

Kystvandrådet anbefaler, at der fra statslig side oprettes en national fond, pulje eller lignende med henblik på storskala marin naturgenopretningsprojekter. Marin naturgenopretning er ofte omkostningsfuldt, og statslig medfinansiering kan derfor være afgørende.

5. *Statslig medfinansieringsmuligheder ift. oplandsindsatser, herunder særligt etablering af vådområder*

Kystvandrådet anbefaler, at der fra statslig side fortsat prioriteres midler til etablering af vådområder. Det anbefales herunder, at der oprettes en national fond eller pulje, der giver mulighed for, at kommuner løbende kan opkøbe jord som buffer til anvendelse i jordfordelingsprojekter.

6. *Fortsættelse af modellen med kystvandråd*

Kystvandrådet ser store styrker i samarbejdet på tværs af erhvervsinteresser og naturinteresser, der i fællesskab kan give lokale perspektiver til indsatsen for et bedre vandmiljø i Odense Fjord. Derfor anbefaler Kystvandrådet;

- a.** at der prioriteres midler til fortsættelse af det lokale arbejde med kystvandråd.
- b.** at det lokale arbejde med kystvandråd fortsætter i en kontinuerlig flerårig proces.
- c.** at resultater fra kystvandrådets arbejde integreres i den nationale vandplanlægning.
- d.** at modellen for kystvandråd udbredes til flere dele af landet.

Tilstandsbeskrivelse og systemforståelse for Odense Fjord (AP 1.1)

Status description of Odense Fjord

Mikkel K Lees, Frederik H Hansen, Niels Svane, Mogens R. Flindt & Paula Canal-Vergés.

Dansk resumé

Dette afsnit opsummerer den aktuelle miljøtilstand i Odense Fjord samt en systematisk redegørelse for de forskellige pres-faktorer der er identificeret i Odense Fjord og som indvirker på ålegræs vækst og reetablering. Odense Fjord er, med en middel dybde på 2.2 m, generelt lavvandet hvor arealer med dybder fra 0 ned til 2.2 meter udgør ca. 60% af hele fjordens areal (Figure 1). Odense Fjord har et stort opland hvoraf omkring 64% er opdyrket landbrugsareal. Der ses en klar eutrofieringsgradient i Odense Fjord som generelt er kraftigt næringssaltsbelastet med DIN og DIP koncentrationer som langt overskrider grænseværdierne for ålegræs reetablering og positiv vækst (Figure 2). Den kraftige eutrofiering fastholder fjorden i en dårlig miljøtilstand kendetegnet ved høj andel af organisk indhold i sedimentet som negativt påvirker ålegræssets reetableringsvene ved dårlige forankringsforhold af udplantede ålegræsskud og større dele af sedimentet som let resuspenderes ved lave grader af fysisk stress ved bunden (Figure 7). Lysforholdene er generelt gode i store dele af fjorden da denne generelt er lavvandet. De dybere områder i yderfjorden er dog presset af dårlige lysforhold som resultat af høj eutrofieringsdrevet turbiditet (Figure 3). Områderne i inderfjorden hovedsagligt er domineret af opportunistiske makroalge arter og Phytoplankton samt kraftig epifytvækst (Figure 4). I yderfjorden muliggør den lidt højere salinitet og mindre eutrofieringspres vækst af flerårige makroalge arter som f.eks. *Fucus sp* (Figure 5). Da ålegræs er sensitivt overfor varige iltsvind, blev iltforholdene monitoreret med ilt loggere i Odense Fjord. Her er der vist data fra én logger i inderfjorden og én i yderfjorden. Generelt har Odense Fjord ikke store problemer med iltkoncentrationen da den er så lavvandet. Alligevel blev der særligt i efteråret målt både moderat og kraftigt iltsvind (Figure 6). De benævnte presfaktorer på ålegræsset har i årevis haft en negativ indvirkning på udbredelsen af ålegræs i Odense Fjord og er nu reduceret til omkring 1.5% af arealet i Odense fjord med ålegræs dække (Figure 8 & Figure 9). Dette er blot en hurtig gennemgang af hvad afsnittet omhandler og det, i forhold til overordnet systemforståelse og detaljeret gennemgang af de forskellige pres-faktorer, anbefales at læse hele notatet i dets fulde omfang.

Current environmental status of Odense Fjord

Physical parameters and annual nutrient loading

Odense Fjord (OF) has a total area of 61 km² and an average depth of 2.2 m. The average depth of 2.2 m constitutes around 60% of the entire water body area (Figure 1). A deep and narrow navigation channel oriented in a north/south direction runs from the inlet of the fjord at the headland Enebærodde to Odense harbour in the inner-most part of the fjord. The maximal tidal amplitude is 0.5 m and the average residence time of Odense River water is 17 days (Fyn County 2003). Using the hydrodynamic module of the Mike 3D model complex used in the Kystvandråd project we calculated the average residence time of Odense Fjord finite elements to be 21 days. The catchment area of OF is 1095 km² of which about 60% land use is agricultural (Windolf et al. 2013). From the seven main rivers leading to Odense fjord, Odense River is the major contributor. Odense River discharge into the shallow inner part of OF (mean depth of 0.8 m) and is the largest source of total external nutrient loading, 1700 ton N y⁻¹ and 64 ton P y⁻¹ (Windolf et al. 2013). In recent years the N and P loading to OF has decreased

to 1443 and 40.9 ton N and P y^{-1} , respectively, and by year 2027 the loading is expected to decrease further to 1300 and 39.9 ton N and P y^{-1} , respectively (Miljøstyrelsen 2021). The inner fjord is highly eutrophic and with high concentrations of dissolved inorganic nutrients (DIN and DIP) the inner fjord is mainly dominated by opportunistic macroalgae (e.g., *Ulva lactuca*, *Chaetomorpha linum*) semi opportunistic rooted vegetation (*Rupia maritima*) and high turbidity due to excessive growth of phytoplankton and frequent resuspension events. The deeper outer part of the fjord (mean depth is 2.7 m) has a lower nutrient pressure compared to the inner fjord and is largely dominated by perennial macroalgae (e.g., *Fucus vesiculosus*, *Fucus serratus*) and very sparse rooted vegetation (*Zostera marina*) and higher current and wave activity (Kuusemäe et al. 2016).

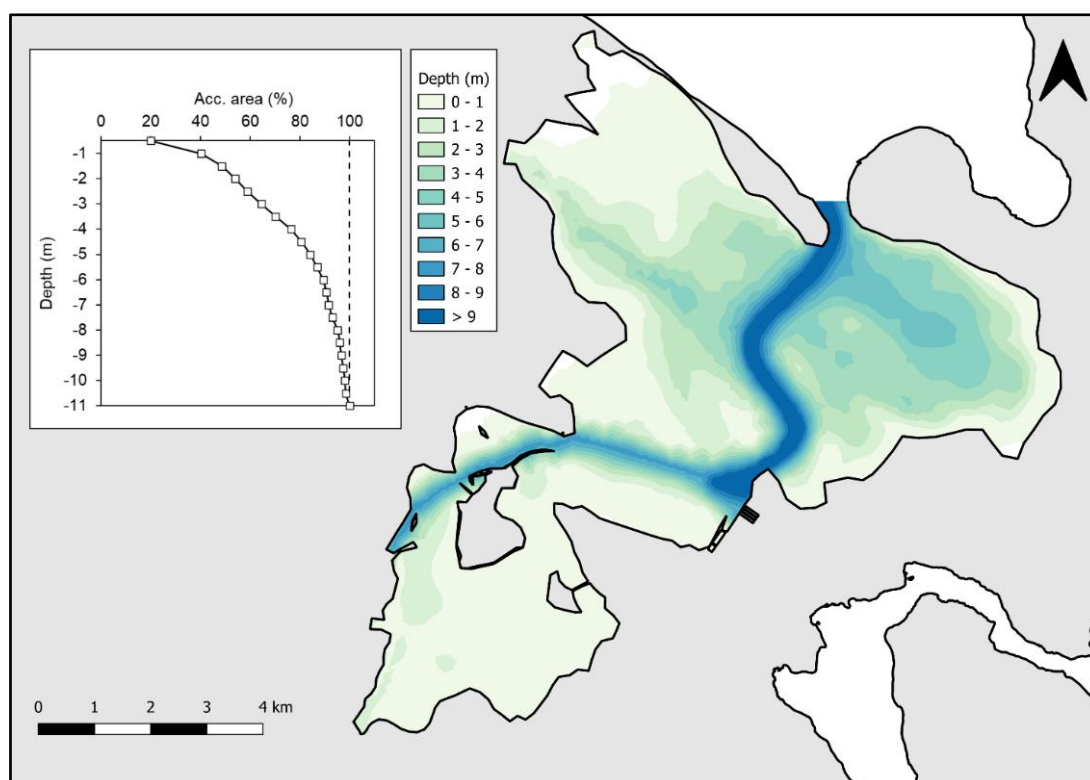

Figure 1. Odense Fjord, Denmark. Bathymetry and hypsograph of Odense Fjord. Scalebar is 4 km.

Eelgrass stressors and press factors

Marine ecosystems such as Odense Fjord are dynamic, with many different stressors acting on the primary production. In balanced systems, the primary production is mainly dominated by a healthy benthic production and a minor pelagic and opportunistic production where the benthic production such as seagrasses can cope with physical stressors such as wave and current induced shear stress. In such a state the seagrass is providing numerous important ecosystem services such as growth-related nutrient retention, stabilizing sediments and acting as nursery grounds for juvenile fauna species (Duarte 2000; Duffy 2006; Hemminga and Duarte 2000; Orth et al. 2006; Terrados and Duarte 2000) that help in keeping the system in a healthy state. However, with increased nutrient loading and thus eutrophication pressure, the balance is shifted, and the primary production becomes dominated by pelagic production and opportunistic/semi-opportunistic benthic vegetation leading to a deteriorated light climate and increased pools of organic matter in the sediments. This increases the effects of the natural stressors already present in the system previously kept in a delicate balance and thus the overall pressure on eelgrass severely affecting eelgrass growth and spatial abundance. This section

systematically investigates the different stressors in Odense Fjord and their current status, which are keeping the system in a deteriorated environmental state.

Nutrient dynamics and loading

Despite efforts to reduce the nutrient loading to the fjord the N and P loading is still high constituting external sources a major part of the nutrient source to the system. During the years 2022 and 2023, water samples for the analyses of Dissolved Inorganic Nitrogen (DIN) and Dissolved Inorganic Phosphorus (DIP) were collected periodically in 21 stations along Odense fjord. On addition, we collected relevant results from the mechanistic model of Odense fjord used in the third Danish River Basing Management Plan (RBMP3, 2003-2016, (Canal-Vergés et al. 2021). From these results, it is apparent that the highest DIN loading is found in the inner-most part of the fjord gradually decreasing towards the outer boundary (Figure 2). Highest concentrations are found during the winter, followed by the autumn and summer. During the growth season (01/03 to 1/10), there is a clear gradient with higher concentrations coming from the inner fjord and a single hotspot in Egensedybet (Figure 2, A & B). The monitored data from 2022-2023 and the modelled data from 2002 to 2016 follows the same patterns along the fjord, however, the DIN concentrations in the model are generally higher (Figure 2, A & B). In both cases, good conditions are found only in the outermost part of the fjord. Average DIP during the growth season is as well higher in the inner fjord, whereas the hotspot of Egensedybet is not so pronounced (Figure 2, C & D). The measured DIP is generally higher than the modelled DIP, this difference is the highest in the inner fjord (Figure 2, C & D). This nutrient gradient is primarily maintained by the large runoff of nutrients from the Odense River catchment area which constitutes the largest catchment to the fjord. The hotspot found in the outer fjord is the contribution from the two small rivers from Egensedybet, which contributes only with 4 % of the total load of the fjord. The high nutrient pressure to the fjord stimulates the pelagic primary production in terms of phytoplankton and growth of benthic opportunistic macroalgae on the expense of eelgrass and perennial/semi-perennial macroalgae. The immediate effect of excess growth of both phytoplankton and opp. macroalgae is a deteriorated benthic light climate, due to shading, affecting growth of benthic perennial primary producers such as eelgrass. However, irreversible changes in the sediment characteristics, such as increase of organic matter and increase of the finer particle classes, have been shown to be consequence of the elevated nutrient pressure (Valdemarsen et al. 2014), rendering Odense Fjord into a highly eutrophic system. Furthermore, the disappearance of rooted vegetation such as eelgrass, not only sustain the fast nutrient turnover, but also enhance the frequency of resuspension due to the decrease of the critical shear stress at the area. Muddy sediment prompt to frequent resuspension together with a short nutrient turn over, create frequent turbidity in the water column, which sustain the long-term eutrophication effects even further. On top, the pool of organic matter built up in the sediment, result in an internal loading of nutrients that are being realized at different periods during the year and contribute to further deteriorated environmental conditions (Valdemarsen et al. 2015). Conclusively, the sustained high nutrient loading has been keeping the system in a eutrophic state and being its derived effects, the main drivers of the present impoverished environmental state. In the following sections the derived effects are presented.

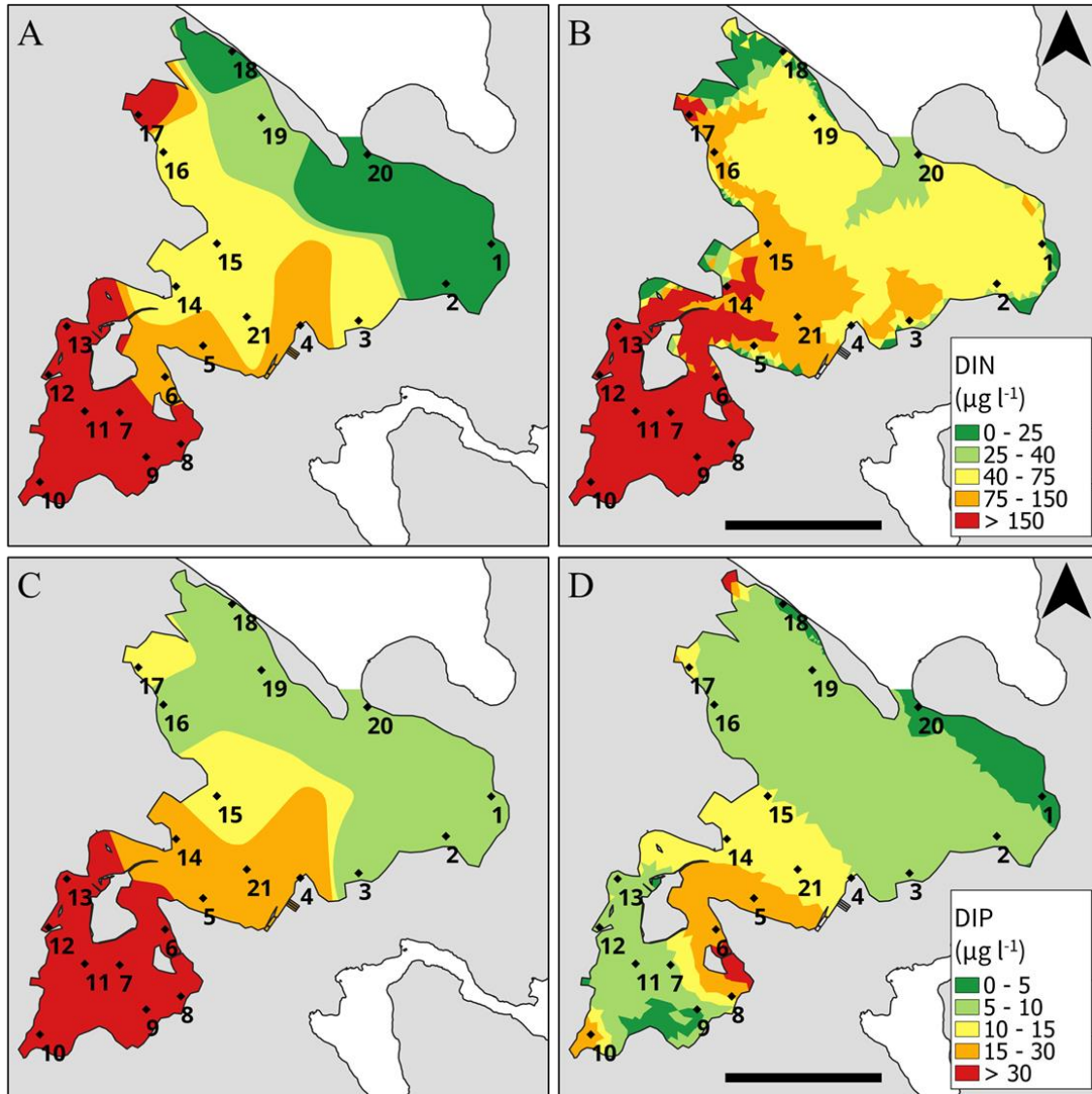

Figure 2. Odense fjord, Denmark. Growth season average DIN and DIP based on field measurements (A & C)

Benthic light climate

The benthic light climate is an important factor in analysing the environmental state of a marine ecosystem. In Danish coastal waters in an oligotrophic state sufficient light reach the bottom providing a benthic light climate able to sustain a healthy benthic primary production. However, with eutrophication the benthic light climate has deteriorated and with it much of the benthic primary production. The threshold for sustaining net production of eelgrass in Danish coastal waters is estimated to about $200 \mu\text{E m}^{-2} \text{s}^{-1}$ and used as a general threshold anywhere in the specific system (e.g., Odense Fjord) (Flindt et al. 2016). However, preliminary results show that the threshold value of benthic light intensity able to sustain eelgrass growth is dynamic and changes along the eutrophication gradient as a function of the impact from multiple stressors that are also dynamic along the gradient. These results are not yet published, therefore the light threshold at $200 \mu\text{E m}^{-2} \text{s}^{-1}$ will be used for the present study. In a model study by Flindt et al. (2016) the results showed that about 55% of Odense Fjord was able to achieve light conditions above the threshold and thus sustain eelgrass growth. Much of this area, however, is severely affected by other stressors preventing eelgrass growth and recovery. Among them the overgrowth of opportunistic species such as epiphytes

which shade eelgrass leaves negatively affecting their photosynthetic capacity. In addition, much of the area not living up the light threshold is found in the outer fjord (Figure 3) where the degree of other eutrophication related stressors is less severe. During 2022 light loggers were placed at five shallow stations (~1,5-2 m depth), four in the outer fjord and one in the inner fjord (Figure 3). Eelgrass transplantation experiments were performed at all of these locations (see chapter “marine mitigation tools”). We also collected the average benthic light during growth season from the RBMP3 model (2002-2016). At 1,5 to 2 m depth, the higher light levels during the growth season were found in the northwest part of the fjord, followed by the northeast and finally by the inner fjord. All station shows optimal (northwest) or good levels (northeast and inner fjord) of light for eelgrass growth during the growth season. The inner fjord is the only station that shows levels below the threshold for growth during the beginning of the growth season (March). These measurements validate the RBMP3 model results for light distribution in Odense fjord. The development of eelgrass shoot densities from test transplantation activities are further explained in chapter “marine mitigation tools”.

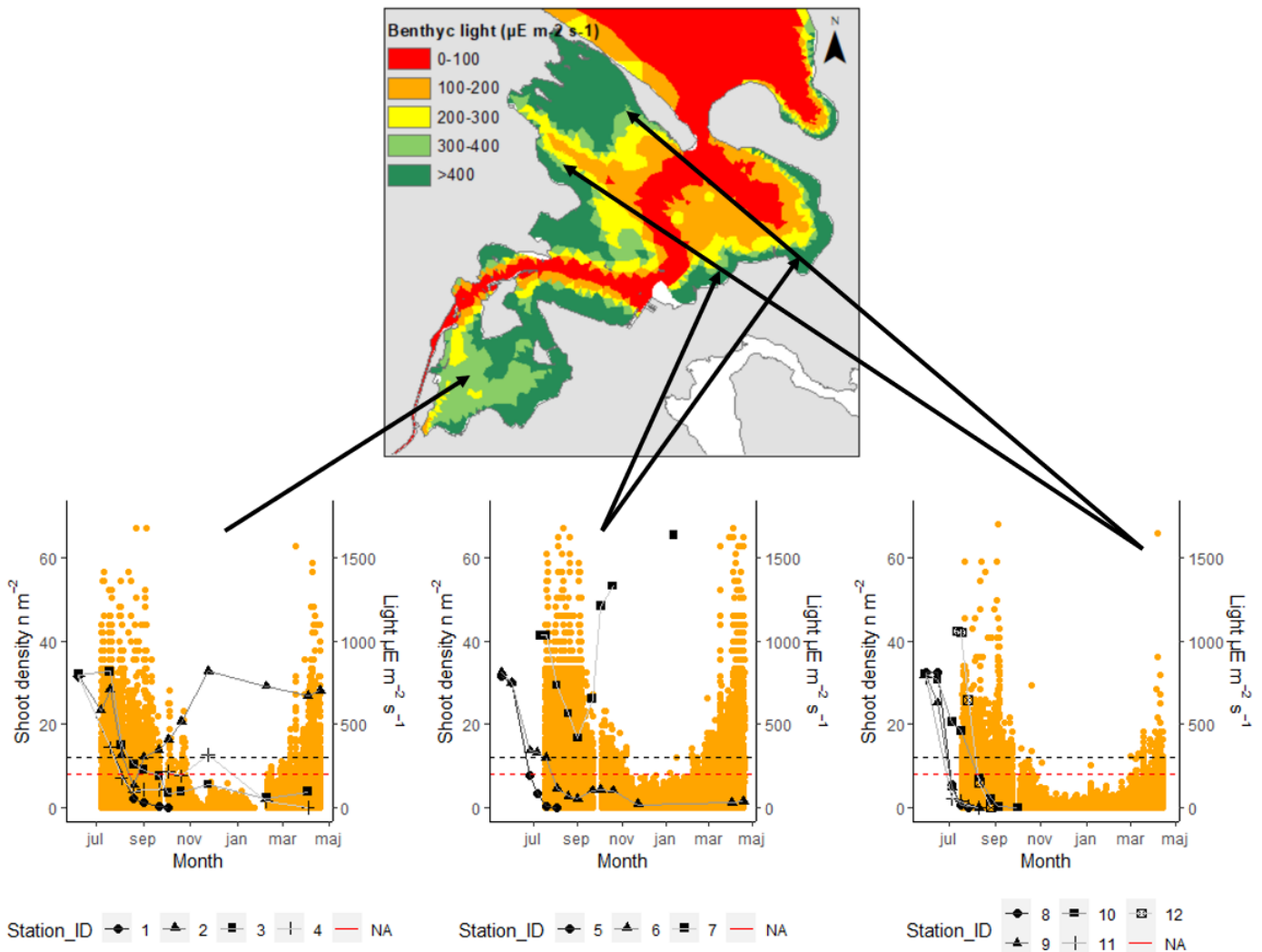

Figure 3. Odense fjord, Denmark. Benthic light. A) Modelled benthic light (growth season average, 2002-2013). B) Monitored light concentration in the inner fjord and shoot density of transplanted eelgrass beds at four stations during 2022. C) Monitored Average light concentration in the West outer fjord and shoot density of transplanted eelgrass beds three stations during 2022. D) Monitored Average light concentration in the East outer fjord and shoot density of transplanted eelgrass beds five stations during 2022.

*Dotted red line represent optimal light concentration for eelgrass growth, dotted black line represent threshold light concentration for eelgrass growth.

Pressure from opportunistic macroalgae and phytoplankton

Opportunistic macroalgae acts as a stressor on eelgrass growth and recovery due to shading and drifting macroalgae mats uprooting eelgrass seedlings (Valdemarsen et al. 2010). It has been quantified that an area-specific biomass of opp. macroalgae at $> 13 \text{ g C m}^{-2}$ creates impairs eelgrass growth and recovery while a biomass exceeding 26 g C m^{-2} would severely impact eelgrass recovery (Flindt et al. 2004; Flindt et al. 1997). A threshold of 10 g C m^{-2} was estimated to be the tipping point of negative effects from opp. macroalgae on eelgrass recovery (Flindt et al. 2016). Increased pelagic production (i.e., phytoplankton production) is the immediate effect of heavy nutrient loading and is directly coupled to changes in the light attenuation in the water column and thus, the benthic light availability. A shift from benthic to pelagic primary production with increased phytoplankton growth severely affects light availability and reduces the area available for benthic production. In addition, both phytoplankton and opportunistic macroalgae species are easily degradable and contribute to a high turnover, releasing nutrients bound in their tissue back into the water column as available inorganic nitrogen and being realised in further pelagic growth. This turnover of organic nitrogen can happen several times during a growth season which further enhances the enrichment of the sediments increasing the pool of organic matter in the seabed. In Odense Fjord both opp. macroalgae and phytoplankton are very abundant in the inner fjord, following the eutrophication gradient. In the inner fjord opp. macroalgae biomasses reaches above threshold values, negatively affecting eelgrass recovery by rendering around 20% of the total area in Odense Fjord unsuitable for eelgrass growth and recovery (Figure 4). During 2023 (August), the benthic vegetation of the inner fjord was monitored in detail. Opportunistic macroalgae (together with semi-opportunistic *Rupia maritima*), were found to be the dominating species in the inner fjord. The opportunistic macroalgae distribution in the inner fjord, fitted the distribution simulated in the RBMP3 model for the inner fjord (Figure 4). The distribution of opportunistic species, follows as well the DIN gradient in the growth season.

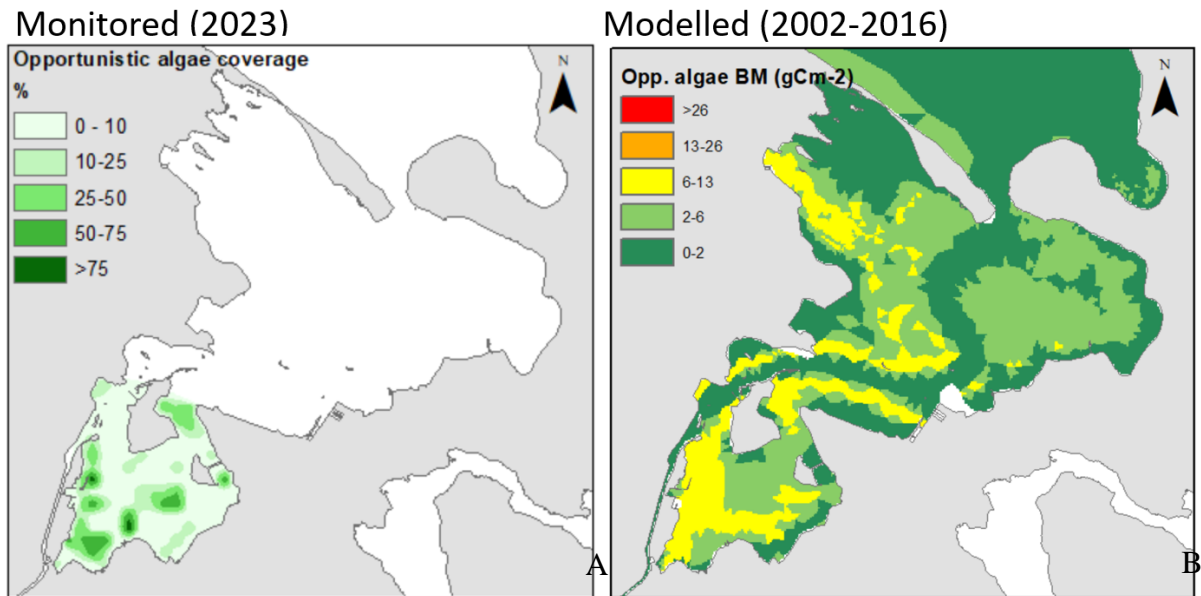

Figure 4. Opportunistic macroalgae coverage in Odense fjord. A) Monitored opportunistic macroalgae coverage in the inner Odense fjord (August 2023). B) Modelled biomass of opportunistic macroalgae (Maximum of the growth season) in Odense fjord.

Pressure from perennial mobile macroalgae

Large hard substrate is lacking in many Danish fjords and estuaries (e.g., stone- and boulder reefs), hence perennial macroalgae species such as *Fucus sp.* and *Gracilaria sp.*, grows attached to small stone and shells. While growing, buoyancy of the macroalgae changes, becoming more buoyant by the formation of the air vesicles that characterise these species. Once the macroalgae-substrate complex becomes positively buoyant, these macroalgae becomes mobile (Canal-Vergés et al. 2010). The macroalgae attached stone/shell, can cause physical damage to eelgrass seedlings, negatively effecting eelgrass recovery (Valdemarsen et al. 2010). However, when attached to stable substrate, these perennial macroalgae species are indicator for better water quality than the opportunistic and semi opportunistic species. In Odense Fjord about 20% of the total area fall within this threshold interval where eelgrass recovery is negatively affected by drifting macroalgae. All of these areas are found in the outer fjord (Figure 5). In addition, this pressure is further enhanced since perennial macroalgae inhabits the same areas as eelgrass (Flindt et al. 2016) due to some similarities in their respective growth kinetics.

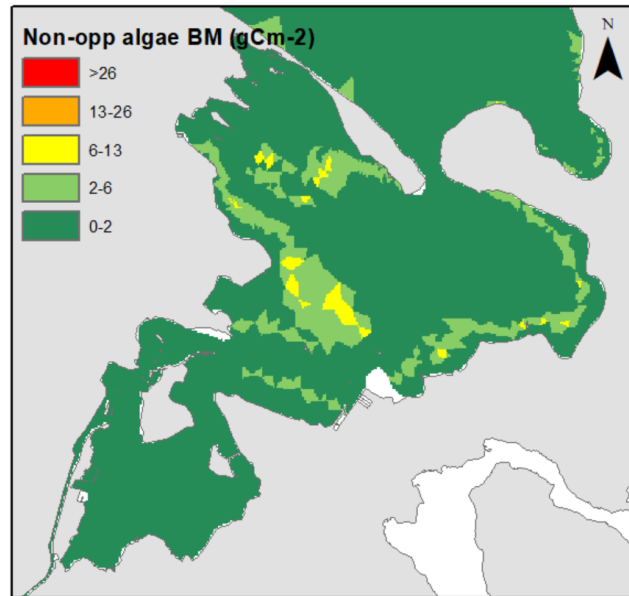

Figure 5. Modelled biomass of non-opportunistic macroalgae (Maximum of the growth season) in Odense fjord.

Oxygen dynamics

Frequent and persistent oxygen depletion may cause deteriorated growth conditions and even severe die-off of many species of both flora and fauna. Low oxygen concentration is a major problem in Danish coastal waters especially in the late summer and early autumn where temperatures are still sufficiently high to support mineralization processes of the organic content in the sediment. During the growth season a large pool of labile organic material is produced from the seasonal algal blooms settling on the sediment. The organic content on the seafloor is being mineralized at the expense of heavy oxygen consumption. Eelgrass is shown to be sensitive to water column oxygen concentrations below 1 mg O₂ l⁻¹ for about 1-3 days per week (Flindt et al. 2016) where such conditions negatively affects eelgrass recovery and growth with possible large scale die-off. In Odense Fjord loggers have been placed in the inner- and outer fjord continuously logging the oxygen concentrations (10 minutes interval), for the period July 2022 to July 2023 (Figure 6). In the inner fjord minor to moderate anoxia was recorded in 2022 with event durations below 5 hours. No severe anoxic events were seen. In June 2023 both moderate and severe anoxia was recorded, however, event durations was still below 5 hours. In the outer fjord moderate- and severe anoxic events were recorded in September 2022 where the duration of the events was between 65-75 and 50-60 hours for moderate and severe anoxic events, respectively. No anoxic events were recorded in 2023 in the outer fjord. It is important to note that the time series only encompassed data up until July 2023, thus excluding the autumn period of 2023 known for their frequent occurrence of anoxic events as seen in September 2022. Despite the recorded anoxic events in 2022 and 2023 Odense Fjord is not known for severe anoxia mainly due to the shallow mean depth where the water column usually is well mixed and is frequently reaerated (Flindt et al 2016, Canal-Vergés et al 2021).

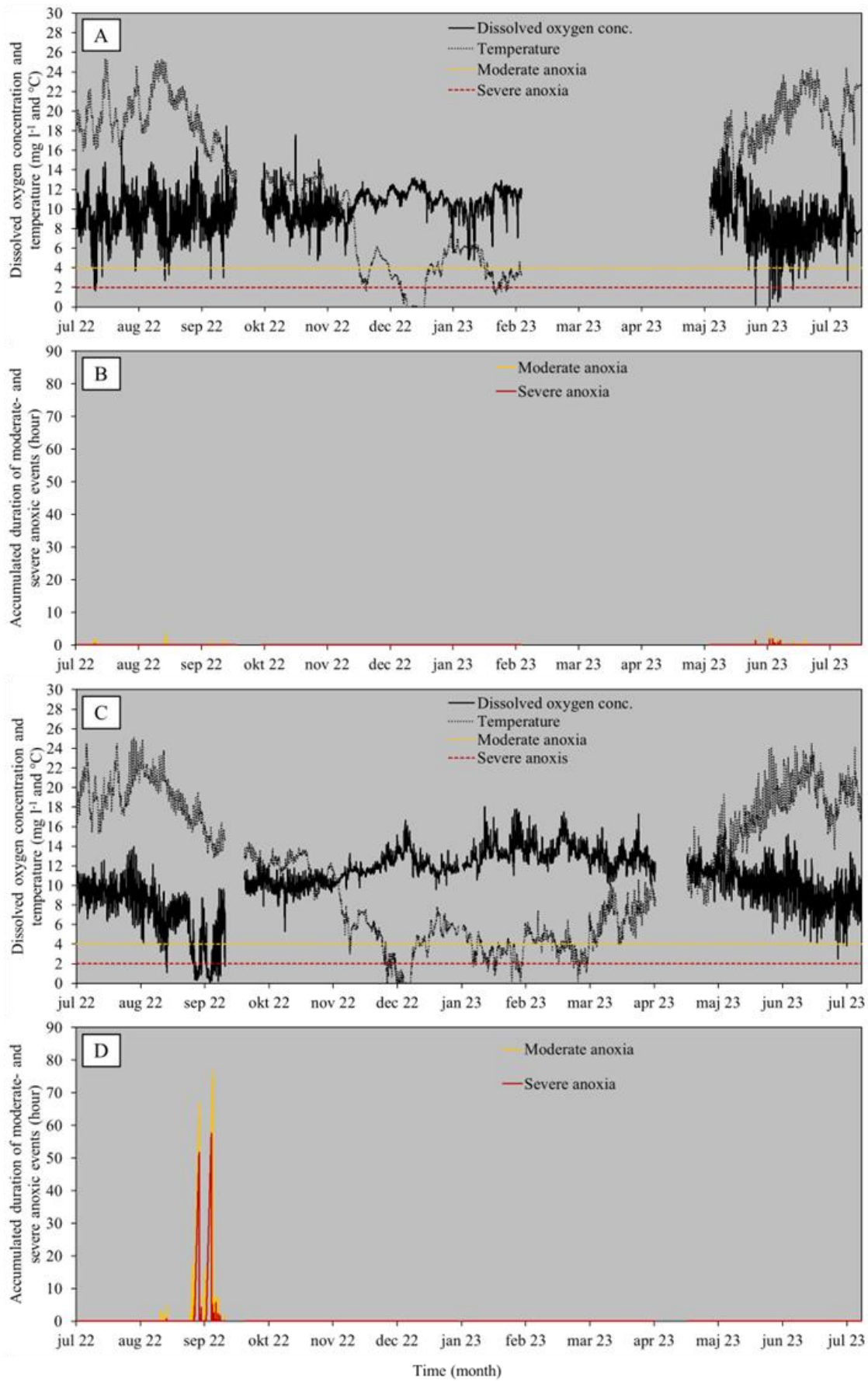

Figure 6. Odense Fjord, Denmark. Dissolved oxygen concentration (DO), temperature (T) in Odense inner fjord (Seden Strand, A) and in the Odense outer fjord (Enebærodde, C) along with the accumulated duration of continuous anoxic events in Seden Strand (B) and Enebærodde (D). Anoxic events are divided into moderate ($DO < 4 \text{ mg l}^{-1}$) and severe ($DO < 2 \text{ mg l}^{-1}$) anoxia.

Resuspension frequency and sediment characteristics

The sediment organic content measured as loss of ignition (LOI) can be used as a proxy for the anchoring capacity of the sediment i.e., the capability of eelgrass seedlings to anchor in the sediment in the early recovery stage. With medium to high organic content in the sediment the seedlings are unable to properly anchor and may be damaged or uprooted by sufficiently high bed shear stress (Flindt et al. 2007; Lillebø et al. 2011; Valdemarsen et al. 2010). In addition, organic rich sediments are easier to resuspended resulting in deteriorated light conditions. In terms of eelgrass morphology, this environmental conditions trigger the plant to grow on produce longer leaves and shorts roots creating a high-drag low-anchoring capacity status and is far more vulnerable to high physical stress. From field campaigns in Odense Fjord a threshold of organic content was established meaning that eelgrass is not able to recover in areas with higher organic content than about 2-5 % LOI (Flindt et al. 2016; Valdemarsen et al. 2010). In addition, in areas with organic content above 4 % LOI eelgrass is usually not present (Wicks et al. 2009). The sediment conditions of a wide range of stations in Odense fjord were monitored in 2009. The organic content (LOI %) of the sediment samples was analysed at sediment depths of 0-1, 1-2, 2-6 and 6-15 cm. The RBMP3 model also included a LOI, layer describing the fjord's surface sediments. In general terms both data sets coincide on that in the outer fjord, the northeast area is very sandy, whereas the south east and the deeper areas of the west are defined by organic reach sediments (Figure 7). In the inner fjord the monitored data present higher levels of LOI than the modelled data. However, both encounter a higher organic content in the east area of the inner fjord (Figure 7).

Finally, as some areas are more exposed than others, the resuspension frequency also plays an important role in eelgrass recovery and growth. In areas with high exposure the sediments are more frequently resuspended deteriorating the light climate (Canal-Vergés et al. 2010), and affected by high physical stress which renders the seafloor material too coarse for eelgrass seeds to settle and grow into seedlings. A threshold of monthly resuspension was established by Flindt et al. (2016) where more frequent resuspension than monthly would negatively affect eelgrass growth and recovery and where areas with daily resuspension are deemed as lost habitats for eelgrass recovery. In Odense Fjord around 80% of the total area shows weekly and daily resuspension frequencies and is thus considered as unavailable area for eelgrass recovery (Canal-Vergés et al 2021). About 20 and 40% of the total area in Odense Fjord was deemed unsuitable for eelgrass recovery in relation to physical shear stress and organic content, respectively (Flindt et al. 2016).

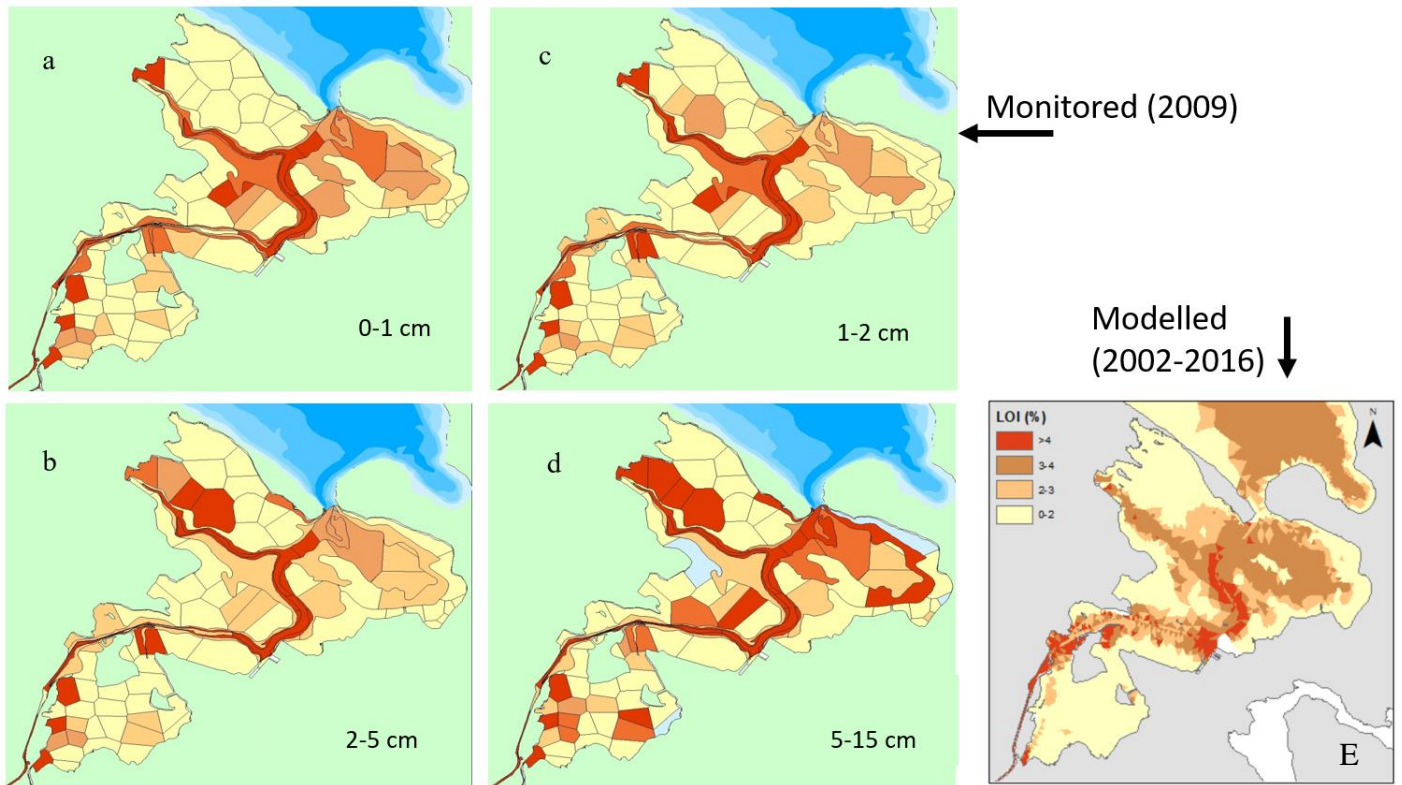

Figure 7. Odense fjord, Denmark. Organic content in marine sediments. A, b, c, d Monitored organic content at sediments depths of 1-1, 1-2, 2-6 and 6-15 cm. E, Modelled organic content in Odense fjord (RBMP3)

Lugworm stress

With the decline in spatial coverage and abundance of eelgrass lugworm (*Arenicola marina*) have invaded the bare bottom areas where eelgrass used to grow and hereby reducing the potential for eelgrass recovery. Lugworms negatively effects the eelgrass recovery due to their intense reworking of the sediments leading to burial of eelgrass seeds and seedlings (Delefosse and Kristensen 2012; Greve et al. 2005; Valdemarsen et al. 2011). Especially in the shallow Odense Fjord there is sufficient light availability to sustain a large production of benthic diatoms which is the main food source for lugworms rendering the shallow and productive dieback areas with large populations of lugworms unsuitable for eelgrass recovery. In Flindt et al. (2016) a biomass of 25 g wet weight (ww) m⁻² was estimated as a threshold for eelgrass recovery and where a biomass above 40 g ww m⁻² would severely impact the recovery potential negatively and a biomass below 10 g ww m⁻² would allow for undisturbed recovery.

Eelgrass abundance, production and biomass

The prevalence of eelgrass is essential for a healthy coastal ecosystem due to the many ecosystem services provided by the species. Furthermore, eelgrass is an ecosystem engineering species, which when healthy can partly control its surrounding environment to its benefit. Outside of eelgrass beds and its surroundings, the seed and seedling survival is very low. The seed production is also dependent on the standing eelgrass stock, so the less viable eelgrass beds remaining the lower seed recruitment. Therefore, a certain population stock is necessary to sustain the production of seeds and to protect newly settled seedlings. Presently eelgrass in Odense Fjord is limited to relatively small and fragmented beds in the Western and Eastern outer fjord along with some patches at the inlet to Odense

harbour (Figure 9). These comprise less than 1.5 % of the total area thus showing a substantial decline since the 1960s (Figure 8).

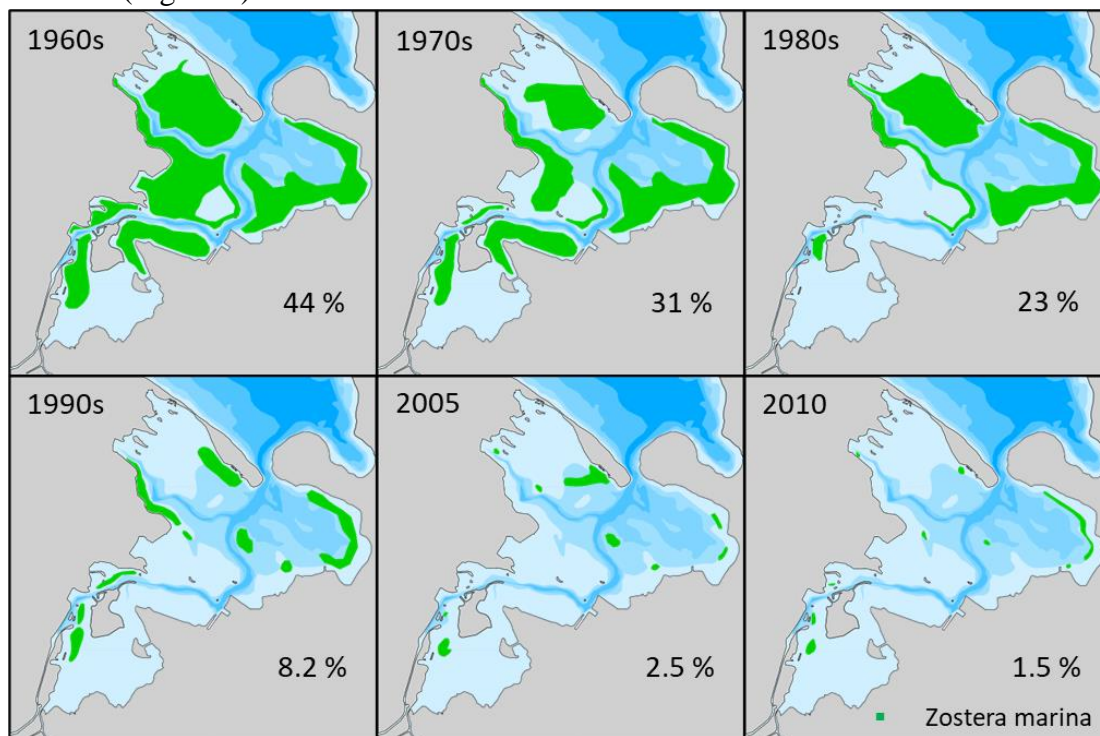
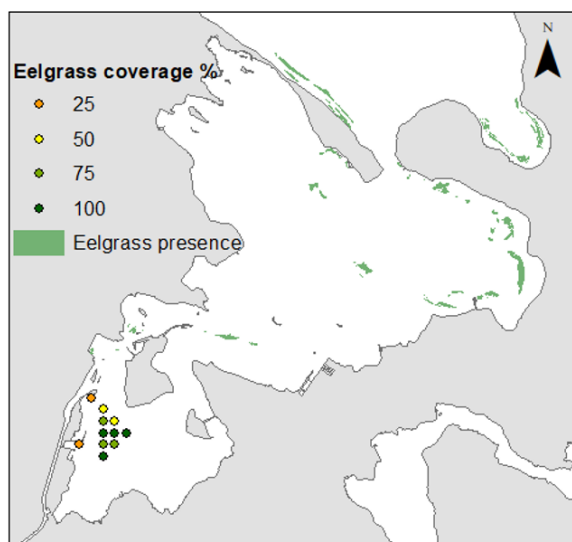

Figure 8. Odense Fjord, Denmark. Historical spatial distribution of eelgrass coverage in the fjord.

The present distribution of eelgrass was mapped in 2022-2023. The outer fjord was monitored using orthophotos, and individual observations in the field, the inner fjord was monitored during August 2023 (Figure 9). Furthermore, the RBMP3 model estimates areas with eelgrass presence (Figure 9). Both datasets highlight similar areas in which eelgrass is present in the fjord. However, the model overestimates the extension of the current beds, especially in the inner part of the outer fjord (Figure 9). Given the narrow and fragmented distribution of eelgrass in Odense fjord, the existing standing stock which can produce flowers, hence seed production is very reduced. This lack of standing stock limits the seed bank decreasing the chances for sexual reproduction further. In Odense fjord, there have been several attempts to test the potential for eelgrass restoration through test transplantations of eelgrass, sand capping of former eelgrass areas that is now turned into muddy bare bottom areas. These field campaigns have been supported by mathematical models and area-based GIS analysis to identify and quantify the restoration potential to improve site-selection of test transplantation (Flindt et al. 2023; Petersen et al. 2021).

Monitored (2023)



Modelled (2002-2016)

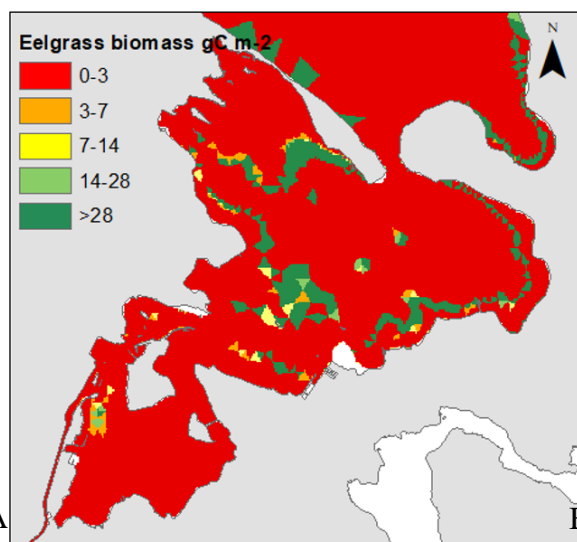

Figure 9. Eelgrass distribution in Odense fjord. A) Monitored Eelgrass distribution in Odense fjord. The outer fjord's distribution was estimated via comparison of orthophotos and field data. The inner fjord was monitored during August 2023. B) Modelled biomass of eelgrass in Odense fjord (Maximum of the growth season), 2022-2023.

References

- Canal-Vergés P, Lees MK, Erichsen AC, Kuusemäe K, Timmermann K, Flindt M. 2021. Application of the danish epa's marine model complex and developments of a method applicable for the river basin management plans 2021-2027: Shallow water effects from nutrient reductions. DHI report (project no 11822953).
- Canal-Vergés P, Vedel M, Valdemarsen T, Kristensen E, Flindt MR. 2010. Resuspension created by bedload transport of macroalgae: Implications for ecosystem functioning. *Hydrobiologia*. 649(1):69-76.
- Delefosse M, Kristensen E. 2012. Burial of *zostera marina* seeds in sediment inhabited by three polychaetes: Laboratory and field studies. *Journal of Sea Research*. 71:41-49.
- Duarte CM. 2000. Marine biodiversity and ecosystem services: An elusive link. *Journal of Experimental Marine Biology and Ecology*. 250(1):117-131.
- Duffy J. 2006. Biodiversity and functioning of seagrass ecosystems. *Marine Ecology-progress Series - MAR ECOL-PROGR SER*. 311:233-250.
- Flindt M, Lundkvist M, Bøgh Pedersen C. 2007. Retablering af ålegræs i fjerde. *Vand & jord*. 3:105-108.
- Flindt M, Neto JM, Amos C, Pardal M, Bergamasco A, Pedersen C, Andersen F. 2004. Plant bound nutrient transport. Mass transport in estuaries and lagoons. In s.L. Nielsen, g.T. Banta & m.F. Pedersen (eds.) *the influence of primary producers on estuarine nutrient cycling: The fate of nutrient biomass*. p. 93-128.
- Flindt M, Salomonsen J, Carrer M, Bocci M, Kamp-Nielsen L. 1997. Loss, growth and transport dynamics of *chaetomorpha aerea* and *ulva rigida* in the lagoon of venice during an early summer field campaign. *Ecological Modelling*. 102(1):133-141.
- Flindt M, Steinfurth R, Banke T, Lees MK, Svane N, Canal-Vergés P, Bramming T, Timmerman K, Stæhr PAU. 2023. Ålegræs - guideline til udpegning af optimale storskala udplantningsområder. Ålegræs - Guideline til udpegning af optimale storskala udplantningsområder.

- Flindt MR, Rasmussen EK, Valdemarsen T, Erichsen A, Kaas H, Canal-Vergés P. 2016. Using a gis-tool to evaluate potential eelgrass reestablishment in estuaries. *Ecological Modelling*. 338:122-134.
- Fyn County. 2003. Odense pilot river basin. Provisional article 5 report pursuant to the water framework directive. Fyn County. 132 pp.
- Greve TM, Krause-Jensen D, Rasmussen MB, Christensen PB. 2005. Means of rapid eelgrass (*zostera marina* l.) recolonisation in former dieback areas. *Aquatic Botany*. 82(2):143-156.
- Hemminga MA, Duarte CM. 2000. *Seagrass ecology*. Cambridge University Press.
- Kuusemäe K, Rasmussen EK, Canal-Vergés P, Flindt MR. 2016. Modelling stressors on the eelgrass recovery process in two danish estuaries. *Ecological Modelling*. 333:11-42.
- Lillebø AI, Flindt M, Cardoso P, Leston S, Dolbeth M, Me P, Duarte A, Pardal M. 2011. Restoration of seagrass community to reverse eutrophication in estuaries. p. 151–164.
- Miljøstyrelsen. 2021. Forslag til vandområdeplanerne 2021-2027.
- Orth RJ, Carruthers TJB, Dennison WC, Duarte CM, Fourqurean JW, Heck KL, Hughes AR, Kendrick GA, Kenworthy WJ, Olyarnik S et al. 2006. A global crisis for seagrass ecosystems. *BioScience*. 56(12):987-996.
- Petersen JK, Timmermann Kr, Bruhn A, Rasmussen MB, Boderskov T, Schou HJ, Erichsen AC, Thomsen M, Holbach A, Tjørnløv RS et al. 2021. Marine virkemidler: Potentialer og barrierer. DTU Aqua rapport nr 385-2021 Institut for Akvatiske Ressourcer, Danmarks Tekniske Universitet. 49 pp. + bilag.
- Terrados J, Duarte CM. 2000. Experimental evidence of reduced particle resuspension within a seagrass (*posidonia oceanica* l.) meadow. *Journal of Experimental Marine Biology and Ecology*. 243(1):45-53.
- Valdemarsen T, Canal-Vergés P, Kristensen E, Holmer M, D. Kristiansen M, Flindt M. 2010. Vulnerability of *zostera marina* seedlings to physical stress. *Marine Ecology-Progress Series*. 418:119-130.
- Valdemarsen T, Organo Quintana C, Flindt M, Kristensen E. 2015. Organic n and p in eutrophic fjord sediments - rates of mineralization and consequences for internal nutrient loading. *Biogeosciences*. 12:1765-1779.
- Valdemarsen T, Organo Quintana C, Kristensen E, Flindt M. 2014. Recovery of organic-enriched sediments through microbial degradation: Implications for eutrophic estuaries. *Marine Ecology Progress Series*. 503:41-58.
- Valdemarsen T, Wendelboe K, Egelund JT, Kristensen E, Flindt MR. 2011. Burial of seeds and seedlings by the lugworm *arenicola marina* hampers eelgrass (*zostera marina*) recovery. *Journal of Experimental Marine Biology and Ecology*. 410:45-52.
- Wicks EC, Koch EW, O'Neil JM, Elliston K. 2009. Effects of sediment organic content and hydrodynamic conditions on the growth and distribution of *zostera marina*. *Marine Ecology Progress Series*. 378:71-80.
- Windolf J, Timmermann A, Bøgestrand J, Kjeldgaard A, Larsen S, Thodsen H. 2013. Landbaseret tilførsel af kvælstof og fosfor til danske fjorde og kystafsnit, 1990-2011. Aarhus Universitet, DCE - Nationalt Center for Miljø og Energi, Aarhus.

Fjordmodel (AP 1.2)

Description of the Odense Fjord model complex

Mikkel K. Lees, Mogens R. Flindt, Anders Chr. Erichsen, Trine Cecilie Larsen & Paula Canal-Vergés

Resumé

Dette afsnit er en teknisk gennemgang af opsætningen af Odense Fjord modellen brugt i kystvandrådsarbejdet som oprindeligt blev opsat som en del af modelkomplekset anvendt i vandplansarbejdet under vandområdeplan 3. Odense Fjord modellen, eller "fjordmodellen" dækker over hele Odense Fjord samt en lille dal af Kattegat samt Dalby Bugt. Modellen består af et hydrodynamisk modul, et bølgemodul, et advektions- og dispersionsmodul og et biogeokemisk modul. Modellen er opsat til at simulere perioden 2002 – 2016 med tvangsfunktioner som repræsenterer denne periode. Modellen under opsætningen både kalibreret og valideret imod målinger foretaget i det nationale overvågningsprogram (NOVANA). Det biogeokemiske modul består af tre dele: den pelagiske- og bentiske del samt sedimentet. Den pelagiske del simulerer primærproduktionen i vandsøjlen samt koncentrationer af planteplankton og detritus, opløst organisk stof samt iltindhold i vandet. I den pelagiske del simuleres både vækst og tab af organismer samt mineralisering af organisk stof. Næringsstofftilførslen til den pelagiske del kan være både eksterne tilførsler (f.eks. afstrømning fra land) og interne tilførsler (f.eks. realisering af den interne pulje af fosfor i sedimentet). Den pelagiske del er koblet til sedimentdelen hvor der ligeledes simuleres vigtige økologiske processor såsom omsætning af forskellige stoffer og nitrifikation/denitrifikationsprocessor. Der kan således ske transport imellem den pelagiske del og sedimentdelen. Den bentiske del simulerer primærproduktion af bentiske primærproducenter såsom ålegræs og makroalger samt mikro-bentiske kiselalger. Denne del er ligeledes koblet til både den pelagiske del og sedimentdelen således at f.eks. ålegræs har mulighed for næringssaltsoptag fra porevandet i sedimentet via rodnettet. Alle primærproducenter beskrives i kulstof, kvælstof og fosfor ækvivalenter. Et indbygget massebalance modul holder styr på alle masser i modellen og sørger for at der er massebevarelse i modellen. Det anbefales at læse hele afsnittet for en fuldkommet og detaljeret forståelse af modellens opsætning samt hvad og hvordan de forskellige elementer indgår og integreres i modellen.

The Mike model complex

To support the preparation of the Danish River Basin Management Plans 2021-2027 (RBMP 2021-2027) DHI developed a model complex consisting of 11 mechanistic models. The development of the model complex was initiated by the Danish Environmental Protection Agency (EPA) and aimed at increasing the spatial coverage of ecological models on a national scale. The RBMP 2021-2027 model complex consists of two regional models, three local models and six estuary models. The regional North Sea model and Inner Danish Waters model (IDW) cover parts of the North Sea, North Atlantic, Baltic Sea and specific parts of Danish water bodies. The regional models are not directly a part of this project. However, regional model results are important in providing outer boundary conditions for the local- and estuary models.

The three local models cover water bodies in the north-western Belt Sea, south-western Belt Sea and Smålandsfarvandet. The north-western Belt Sea model (NBS or Nordlige Bælthav, NBH) covers the marine waters north of Funen as well as e.g., Horsens- (HF) and Vejle (VF) Fjord. The Odense Fjord (OF) model that is used in the Kystvandråd project is one of the six estuary models with increased spatial resolution. All the different models consist of four modules: 1) a hydrodynamic module (HD), 2) a wave module (SW), 3) an advection/dispersion module (AD) and 4) an aquatic ecosystem/biogeochemical module (AEM). The HD module computes physical parameters such as water levels, current speed and direction, salinity and temperature. The SW module computes significant wave height and period, but more important the physical stress on the seabed (shear stress). The AD module is a transport module and computes the advection and dispersion of biochemical components such as particulate and dissolved nutrients. The biogeochemical module (setup in the numerical MIKE solver ECO Lab) computes changes in concentrations of biochemical components due to various ecological processes such as growth and loss processes (Erichsen and Birkeland 2019).

The Odense Fjord (OF) model

The OF model domain covers the whole of Odense Fjord including Dalby Bugt and a small area just outside the Fjord north of Funen. For this project, we only assess Odense Fjord south of the opening Gabet, why all area outside Odense Fjord was removed in the GIS layers (**Fejl! Henvisningskilde ikke fundet.**). The OF model uses a flexible-size unstructured mesh with either triangular or quadrangular finite elements. Different resolutions depending on location within the fjord are used ranging from 150-200 m to 1000 m. Especially areas of potential eelgrass recovery or areas with complex and dynamic flows has higher horizontal resolutions. The vertical mesh is structured and comprise three sigma layers down to -3 m and the rest of the water column is resolved by 18 z-layers of 1 m thickness.

The OF model has one open boundary towards Kattegat. Boundary conditions for water levels is extracted from the regional IDW model while other HD parameters such as water temperature and salinity originate from a measurement station close to the boundary, station FYN6940622. Data on meteorological forcings data (e.g., air temperature, wind speed and direction, humidity) originate from station Odense Airport (Station 612000), StormGeo and Agernæs depending on the parameter and timeframe. Data on the freshwater and nutrient input to Odense Fjord was based on data from the Danish Centre for Environment and Energy (DCE).

Initial conditions on HD parameters are “cold started” except for water temperature and salinity which were “hot started” using monitoring data from within Odense Fjord. The model sources (Figure 10)

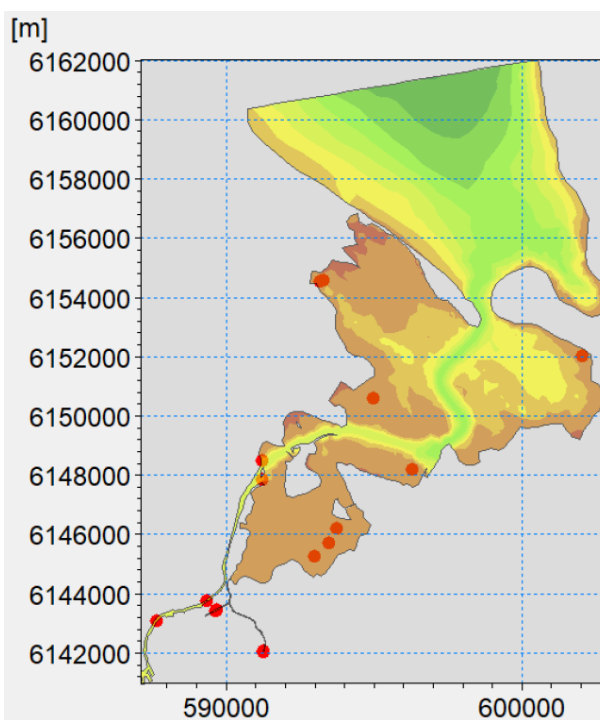

Figure 10. *Odense Fjord*. Red dots show source input points to the model. Nutrient inputs only occur in these locations along with transport across the outer boundary and atmospheric depositions.

of total nutrients (TN and TP) are provided by DCE in time series with daily loadings. Initial conditions for the pelagic values in the AEM module was “hot started” by re-running the year 2002 four times using initial conditions based on measurements from 2002 from within Odense Fjord. Initial conditions for seabed substrates were extracted from EMODnet (2016) mud-data while initial values for benthic vegetation was calculated by a three-year model run with defined initial biomasses in order to reach a steady state situation. See (DHI 2019; 2020) for additional details.

Details on the AEM module

This section is a short summary of a technical note (Erichsen and Birkeland 2019) on the biochemical model (AEM module) which is a part of the scientific documentation of the MIKE model complex used in the RBMP 2021-2027 developed by DHI.

The AEM modules used in the RBMP 2021-2027 model complex comprise three compartments: pelagic-, benthic and sediment compartment. The pelagic compartment simulates the concentrations of phytoplankton, zooplankton, detritus, dissolved organic matter and dissolved oxygen content in the water phase. Phytoplankton growth is modelled because of the phytoplankton primary production minus the results of loss processes. The main factors controlling phytoplankton production are nutrient and light availability along with temperature. Loss processes are mainly controlled by respiration, grazing and sedimentation. The nutrient uptake of phytoplankton is controlled by Monod kinetics where nutrients are taken up into internal pools in the algal cells as a function of the ambient nutrient concentration. The post-uptake phytoplankton growth is then controlled by Droop kinetics (Droop 1968) where growth is a function of the intracellular nutrient concentration. To differentiate between seasonal changes in algal characteristics the AEM models splits the phytoplankton in two functional groups: 1) a diatom state variable for computing the spring bloom, and 2) a flagellate state variable. The diatom state variable introduces non-motile low light dependent algal cells which rely on water turbulence to prevent sedimentation. The flagellate state variable introduces neutrally buoyant algal cells to the model. The phytoplankton concentration is reduced by grazing and decomposition and is either transformed into the zooplankton or detritus state variable (pools). Detritus is described as particulate and dissolved organic matter (C, N and P) and is either subject to sedimentation or bacteria driven remineralization processes (microbial loop). Hence, remineralization of labile organic matter reintroduces otherwise “lost” N and P to the water column several times. These high turnover rates support additional phytoplankton growth influencing the light climate. In addition to detritus from phytoplankton loss processes C, N and P as dissolved organic matter (DOM) is also introduced in the systems by land-based runoff. In the models, DOM is divided into labile dissolved organic matter (LDOM) and relatively refractory colored dissolved organic matter (CDOM). Thus, three states of dead organic matter are computed in the AEM module: detritus, LDOM and CDOM.

The nutrient input in the AEM module can be separated into external sources (e.g., land-based runoff areas such as rivers, direct discharges such as wastewater treatment plants and atmospheric deposition) and internal sources (e.g., sediment fluxes and mineralization of organic matter produced in the water column). Additionally, pelagic recycling is also included in the module where nutrients are recycled in the water column and sediments due to heterotrophic activity.

The pelagic compartment is coupled with a two-layer sediment compartment through several processes such as sedimentation, filtration, nutrient uptake by benthic plants and macroalgae,

bioturbation, mineralization, resuspension and predation. These processes accounts for the exchange of solutes, particles and organisms between the two compartments. A fraction of the internal nutrient source in then pelagic compartment, as mentioned above, is a result of mineralization of organic matter in the sediment. This internal nutrient loading is dependent on the size of the C, N and P pools in the sediment as well as bottom oxygen concentrations, water temperature and bottom water exchange. Organic C, N and P is released to the sediment pore water by the degradation of the C, N and P pools while also, a small fraction is immobilized. The immobilization of organic C, N and P is driven by the C:N ratio and increases with a higher C:N ratio, where a low C:N ratio indicate higher lability of the organic pool. While the degradation is realized by utilizing oxygen or nitrate (NO₃) the rate degradation is dependent on the oxygen- and/or NO₃ availability as well as the C:N ratio in the sediment. The sediment compartment also computes denitrification of N₂ and the binding of inorganic P to oxidized iron (Fe⁺⁺⁺) in an oxidized sediment. Additionally, inorganic P is released to the pore water when the sediment is reduced due to sediment oxygen depletion. The AEM module ensures integration of the pelagic and sediment compartments and allow for sediment/pelagic nutrient exchange and thus, the sediment may act either as a sink or a source of inorganic nutrients to the water phase. This integration is introduced in both regional, local and estuary models and are directly applied to the OF model.

Besides phytoplankton introduced in the pelagic compartment the benthic production compartment introduces four important benthic primary producers: Eelgrass (*Zostera marina*), annual opportunistic macroalgae (e.g., filamentous brown algae and *Ulva* sp.), perennial macroalgae (e.g., *Fucus* sp.), and benthic diatom microalgae. As with phytoplankton the benthic primary production is a result of water temperature, benthic light availability and nutrients. Additionally, eelgrass and perennial macroalgae needs appropriate sediment and substrate conditions, respectively, in order to grow. In the models, sediment conditions are related to sediment bulk density. Since eelgrass is a flowering plant with roots and rhizomes eelgrass take up inorganic nutrients from the sediment pore water and from the water column by the leaves. Thus, If the nutrient concentration in the pore water is sufficiently high this would allow for eelgrass growth even when the inorganic nutrient concentration in the water phase is low. This would also apply for microbenthic diatoms growing on the sediment however, opportunistic and perennial macroalgae can only take up nutrients from the water phase. Benthic growth is regulated by the internal N and P pools and where separate N and P pools are used for each benthic primary producer. The models allow for accumulation of internal nutrients and may drive growth in seasons where the external nutrient loading in surface waters is depleted. Loss in benthic primary production includes respiration, grazing, decay and leaf shedding. Lost benthic primary production is a source of organic matter to the water phase and the sediment where inorganic and organic nutrients are returned to the internal N and P pools through mineralization.

The AEM modules include > 50 state variables which are about equally divided between pelagic and benthic compartments. While the variables attached to the benthic compartments are fixed to the seabed or sediment surface advection and dispersion is introduced to the pelagic state variables due to the movement of water. Finally, a mass-balance module registers the transport, size and exchange of the organic matter and nutrient pools in the different compartments ensuring mass conservation in the models.

References

- DHI. 2019. Development of mechanistic models. Mechanistic model for odense fjord. Hydrodynamic model documentation. DHI report (project no 11822245).
- DHI. 2020. Development of mechanistic models. Mechanistic model for odense fjord. Biogeochemical model documentation. DHI report (project no 11822245).
- Droop MR. 1968. Vitamin b12 and marine ecology. Iv. The kinetics of uptake, growth and inhibition in *monochrysis lutheri*. Journal of the Marine Biological Association of the United Kingdom. 48(3):689-733.
- Erichsen AC, Birkeland M. 2019. Short technical description of the biogeochemical models applied for the mechanistic model development. DHI report (project no 11822245).

Modelvalidering (AP 1.3)

Model validation

Mikkel K. Lees, Mogens R. Flindt, Anders Chr. Erichsen, Trine Cecilie Larsen & Paula Canal-Vergés

Resumé

Dette afsnit omhandler den økologiske model anvendt i kystvandrådsarbejdet og en yderligere validering af denne. Den dynamiske økologiske model eller "fjordmodellen", som den ofte omtales, blev opsat ifm. det danske vandplansarbejde (Vandområdeplan 3) og lå således klar til anvendelse i kystvandrådet. Ved opsætningen af en sådan model og forud for anvendelsen af en sådan sker der en omfattende kalibrering og validering af modellen. Dette arbejde blev udført under opsætningen i vandplansarbejdet. Dog blev der, som følge af nærings saltsmålinger foretaget i Odense Fjord Samarbejdet, besluttet i kystvandrådet at modellen skulle valideres yderligere op imod de nye målinger af kvælstof og fosfor. Der er således foretaget tidsseriesammenligning (Bilag C, D, E og F) og en statistisk sammenligning (Bilag A og B) mellem opløst uorganisk kvælstof- og fosfor (henholdsvis DIN og DIP) imellem de målte koncentrationer på 21 forskellige stationer i fjorden og den simulerede koncentration udtrukket fra modellen på det koordinatsæt som definerer målestationerne. Den statistiske sammenligning er lavet ved t-tests som sammenligner det månedlige gennemsnit imellem hele modelperioden (2002-2016) og feltkampagnens udstrækning (2022-2023). Dette giver i alt 440 statistiske tests fordelt med 220 for DIN og 220 for DIP. Som hovedresultat var der ikke en statistisk forskel mellem den målte og simulerede koncentration i 46 og 47% af de statistiske tests for henholdsvis DIN og DIP (Table 1) og modellen rammer således, indenfor den statistiske usikkerhed, plet på omkring halvdelen af samtlige tests. Sammenligningen er også løftet fra de enkelte målepunkter til et overordnet helikopterperspektiv på system niveau hvor systemets fordelingen af DIN og DIP koncentrationer er sammenlignet på baggrund af koncentrationer udtrukket fra MIKE modellen og interpolerede værdier fra feltkampagnen (Figure 12). Her ses et fint sammenfald mellem modellens og feltkampagnens målinger for DIN. For DIP er der fint sammenfald i yder- og midterfjorden hvorimod modellens koncentrationer for DIP i inderfjorden er noget lavere end de målte værdier. Hovedkonklusionen fra denne yderligere validering er dog stadig at modellen er i stand til at simulere Odense Fjord, et dynamisk økosystem med adskillige parametre og avancerede processor, på meget tilfredsstillende vis.

Model validation on field measurements of DIN and DIP

The ecological model used in the Kystvandråd project was developed as part of the MIKE model complex used in Danish River Basin Management Plans (RBMP) 2021-2027 and was in the development phase successfully calibrated and validated against data from the national monitoring program (NOVANA) during the period 2002-2026. However, due to the work performed in the "Odense Fjord Samarbejdet" consortium, which includes field measurements of dissolved inorganic nitrogen and phosphorous (DIN, DIP) starting in June 2022 running through 2023, another round of detailed model validation was suggested. This includes comparison of simulated vs. measured DIN and DIP on 20 stations in Odense Fjord where nutrient data from the model was extracted as

timeseries for all model years (year 2002 - 2016) on the positions where the water samples were taken (Figure 1).

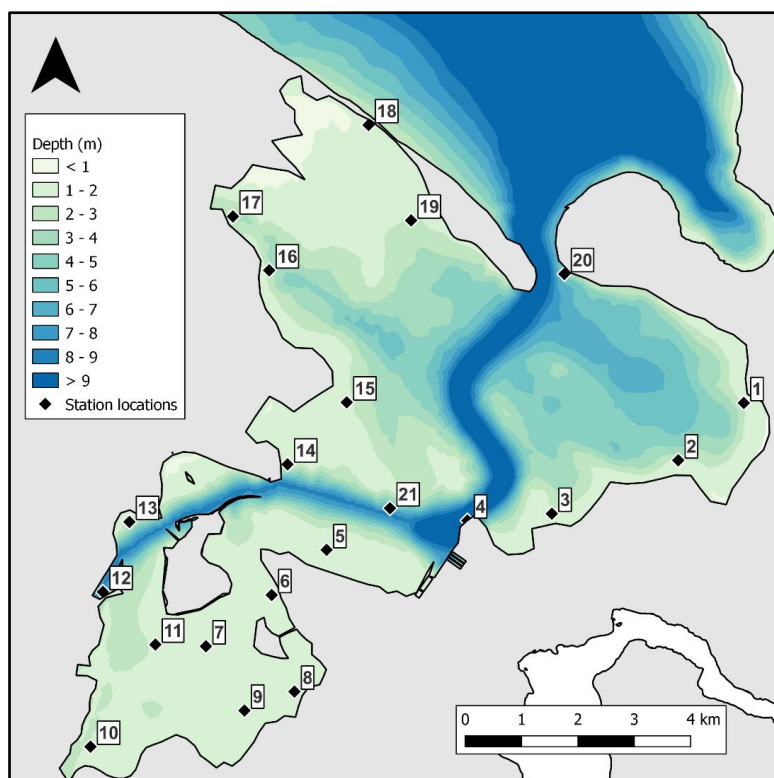

Figure 11. Bathymetry of Odense Fjord and the locations of the sampling stations. Note that station no. 21 is the NOVANA station in Odense Fjord with ID no.: 94230001.

The simulated and measured nutrient data was compared using a *Welch Two Sample t-test* comparing the monthly means each month at each station resulting in a matrix of t-tests of a total of 220 tests (DIN, Table 2 and DIP, Table 3). Station 4 was left out of the analysis since the station was positioned outside the model domain. In some months for a number of stations only 2 samples were taken and has been removed from the statistical analysis. This has been marked as “-“ in Table 2 and Table 3. From a total of 440 t-tests, 119 (DIN) and 117 (DIP) were significant (S, p-value < 0.05) and 101 (DIN) and 103 (DIP) were not significant (NS, p-value > 0.05) meaning that 46 and 47% of all t-tests for DIN and DIP, respectively, were not significant and thus, in 46 and 47% of all combinations there was no statistical difference between model results and field measurements of DIN and DIP, respectively (Table 1), although the monthly averages are from different periods (model results from 2002-2016, and observations from June 2022 throughout 2023).

Table 1. Summary of t-test results for comparing simulated and measured DIN and DIP.

Parameter	Total (#)	NS (#)	S (#)	NS (% of total)
DIN	220	101	119	46
DIP	220	103	117	47

At water body scale, the distribution of modelled (2002-2016) and monitored (2022-2023) DIN in the inner and outer fjords fits. However, at local scale, there are some differences, for most of the areas modelled concentrations are slightly higher, than monitored. In Egensedybet (Northeast of the fjord), the modelled measurements are lower than monitored. For DIP, the modelled and measure data differ significantly in Odense Fjord, Seden Strand, but with a much better fit in the outer part of Odense Fjord.

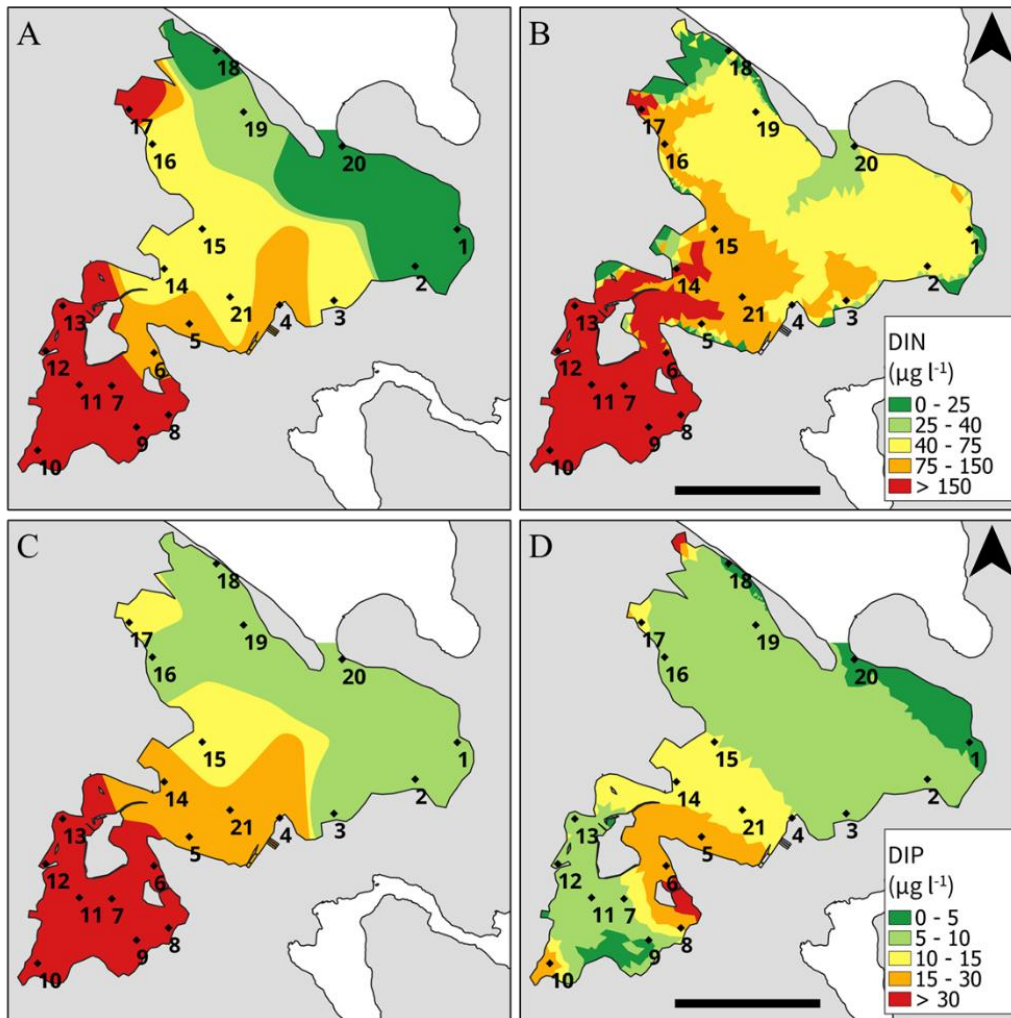

Figure 12. Growth season average dissolved inorganic nitrogen (DIN) concentration in Odense Fjord from interpolated field measurements on 21 stations (June 2022-2023 (A)) and simulated by the MIKE model (2002-2016) (B). The growth season is defined as 1/4 to 31/10. Scalebar is 4 km.

Discussion and conclusion

The modelled data covered the period 2002 to 2016, whereas the monitored data was collected from June 2022-2023. Therefore, it is not expected to find a complete correlation between the two data sets. The year-to-year variations contemplated in the model, are not present in our one year monitored data. However, at water body level, the fjord it is expected to follow the same trends.

The DIN modelled data is shown to be significantly different from the monitored data primarily during the autumn/winter period (September to December, Appendix A, C). Fitting generally better during spring and summer (January to August). As displayed in the calibration period (Figure 3), the

autumn/winter concentrations vary between the years, why the differences between the observations (June 2022-2023) and the model results (2002-2016) could be explained by this variation.

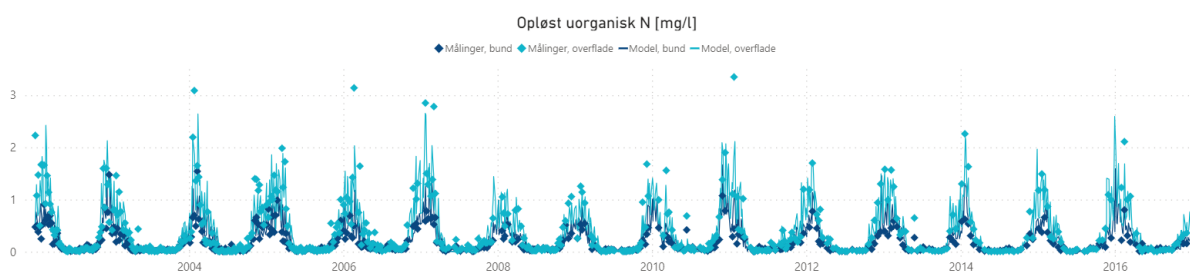

Figure 3. Modelled DIN concentrations in surface (light blue line) and bottom (dark blue line) waters and modelled concentrations (light blue and dark blue diamonds) at station 21.

At water body level, the DIN concentrations found in monitored and modelled data follows the same trend. In the inner fjord, the DIN concentrations measured during the autumn and early winter period (where we find a significant difference, Appendix A, C), are lower than the modelled DIN concentrations. During the late winter, spring, and summer there is not a consistent difference between monitored and modelled data. Here, some stations show higher modelled DIN than monitored, whereas other find the reverse trend. Whereas the autumn and early winter period are more directly impacted by the year-to-year DIN load, especially in the inner part of the fjord, the spring and summer concentrations are also impacted by the nutrient availability and algae growth. In the outer fjord, monitored and modelled concentrations are very close to each other for most stations and all months besides November and December, where the modelled concentrations are higher than the monitored.

Regarding DIP overall, the modelled data is lower than the monitored data. In the inner fjord this difference is more markedly. The most significant differences are found during the spring (Appendix B, D). The inner fjord present higher monitored DIP concentrations when compared to modelled concentrations for most of the stations throughout the year. In the outer fjord, monitored and modelled DIP concentrations are very close to each other for most stations and all months. The RBMP3 model for Odense fjord, is best calibrated for total phosphorus (TP), than DIP ([RBMP \(dhigroup.com\)](http://RBMP.dhigroup.com)). Model calibration shows a slight underestimation of DIP, but a aligned concentration of TP, which might compensate for the overall phosphorus mass balance on the system.

Model data and monitored data coincide on their relative distribution along the fjord with higher concentrations. In fact, the inner most stations 8, 9 and 10 have the highest DIN concentrations of the monitored and modelled samples. However, the differences between modelled and monitored DIP concentrations at stations 8, 9 and 10 are high, where modelled concentrations are lower than the measured.

Overall, looking at the correct distribution of the nutrients along the fjord from monitored and model samples, it can be concluded (based on the difference in periods) that the model set up and general description is relevant to represent current DIN dynamics in the fjord. However, the consequent higher load of DIP in the inner fjord in the monitored samples, suggest that either the DIP load to the model compared to the 2022/2023 differs, the distribution between DIP and TP could be slightly unbalanced or the DIP:DIN and uptake ratios for primary producers slightly inaccurate..

Appendix A – Test matrix results for DIN

Table 2. Matrix of t-test results of simulated vs. measured DIN. Based on the p-value the results are shown as either significant- (S) or not significant (NS) difference between the model results and the field measurements. Combinations marked with “-“ was left out due to low number of samples. Notice that modelled data are from 2002-2026 whereas monitored data are from June 2002-2023.

Station	Month											
	Year 2022						Year 2023					
	6	7	8	9	10	11	12	1	2	3	4	5
1	-	-	-	S	NS	S	S	NS	NS	S	NS	NS
2	-	-	-	S	S	S	S	NS	NS	S	S	NS
3	-	-	-	S	S	S	S	NS	NS	S	NS	NS
5	NS	NS	NS	S	S	S	-	NS	S	S	NS	S
6	S	S	S	S	S	S	-	NS	S	S	S	S
7	S	S	S	S	S	S	-	NS	S	S	NS	S
8	NS	S	NS	-	S	S	S	NS	NS	NS	NS	NS
9	S	S	NS	-	S	S	S	NS	NS	NS	NS	S
10	S	S	S	-	S	S	S	NS	NS	NS	NS	S
11	S	S	S	S	S	S	-	NS	S	S	NS	S
12	NS	NS	NS	NS	NS	NS	NS	S	NS	NS	NS	NS
13	S	NS	S	S	S	S	S	NS	NS	NS	NS	S
14	NS	NS	NS	S	S	S	S	NS	S	S	NS	S
15	NS	S	NS	NS	S	S	S	S	S	S	S	NS
16	NS	NS	S	NS	S	NS	S	NS	S	S	NS	NS
17	NS	S	S	S	S	S	S	NS	S	S	NS	NS
18	NS	NS	NS	NS	NS	S	S	NS	NS	NS	S	NS
19	NS	NS	S	NS	NS	S	S	NS	NS	NS	NS	NS
20	-	-	-	S	S	S	S	NS	NS	S	S	S
21	NS	NS	NS	S	NS	S	-	NS	NS	S	NS	S

Appendix B – Test matrix results for DIP

Table 3. Matrix of t-test results of simulated vs. measured DIP. Based on the p-value the results are shown as either significant- (S) or not significant (NS) difference between the model results and the field measurements. Combinations marked with “-“ was left out due to low number of samples. Notice that modelled data are from 2002-2026 whereas monitored data are from June 2002-2023.

Station	Month											
	Year 2022						Year 2023					
	6	7	8	9	10	11	12	1	2	3	4	5
1	-	-	-	NS	NS	S	S	NS	NS	S	S	S
2	-	-	-	S	S	NS	S	NS	NS	S	S	S
3	-	-	-	S	S	NS	NS	NS	S	S	S	S
5	NS	S	S	S	NS	NS	-	S	S	S	S	NS
6	NS	S	S	S	NS	NS	-	NS	NS	S	S	S
7	NS	S	S	S	NS	NS	-	NS	S	S	S	NS
8	S	S	NS	-	S	NS	NS	NS	NS	NS	NS	NS
9	S	S	S	-	NS	S	NS	S	NS	S	NS	NS
10	S	NS	S	-	NS	NS	NS	S	NS	NS	NS	NS
11	NS	S	S	S	NS	NS	-	NS	S	S	S	NS
12	S	S	S	S	NS	NS	NS	NS	NS	S	S	S
13	S	S	S	NS	NS	NS	NS	NS	NS	S	NS	S
14	NS	S	S	NS	S	S	NS	S	NS	S	S	S
15	S	NS	S	S	NS	NS	S	NS	NS	S	S	S
16	NS	NS	NS	NS	S	NS	S	NS	S	S	NS	S
17	NS	NS	NS	NS	NS	NS	S	NS	S	S	NS	S
18	S	NS	NS	S	S	S	NS	NS	S	S	S	S
19	NS	NS	NS	S	S	NS	NS	NS	S	S	S	NS
20	-	-	-	NS	NS	NS	S	NS	NS	S	S	S
21	S	S	S	S	NS	S	-	S	S	S	S	S

Appendix C – Inner Fjord stations (DIN)

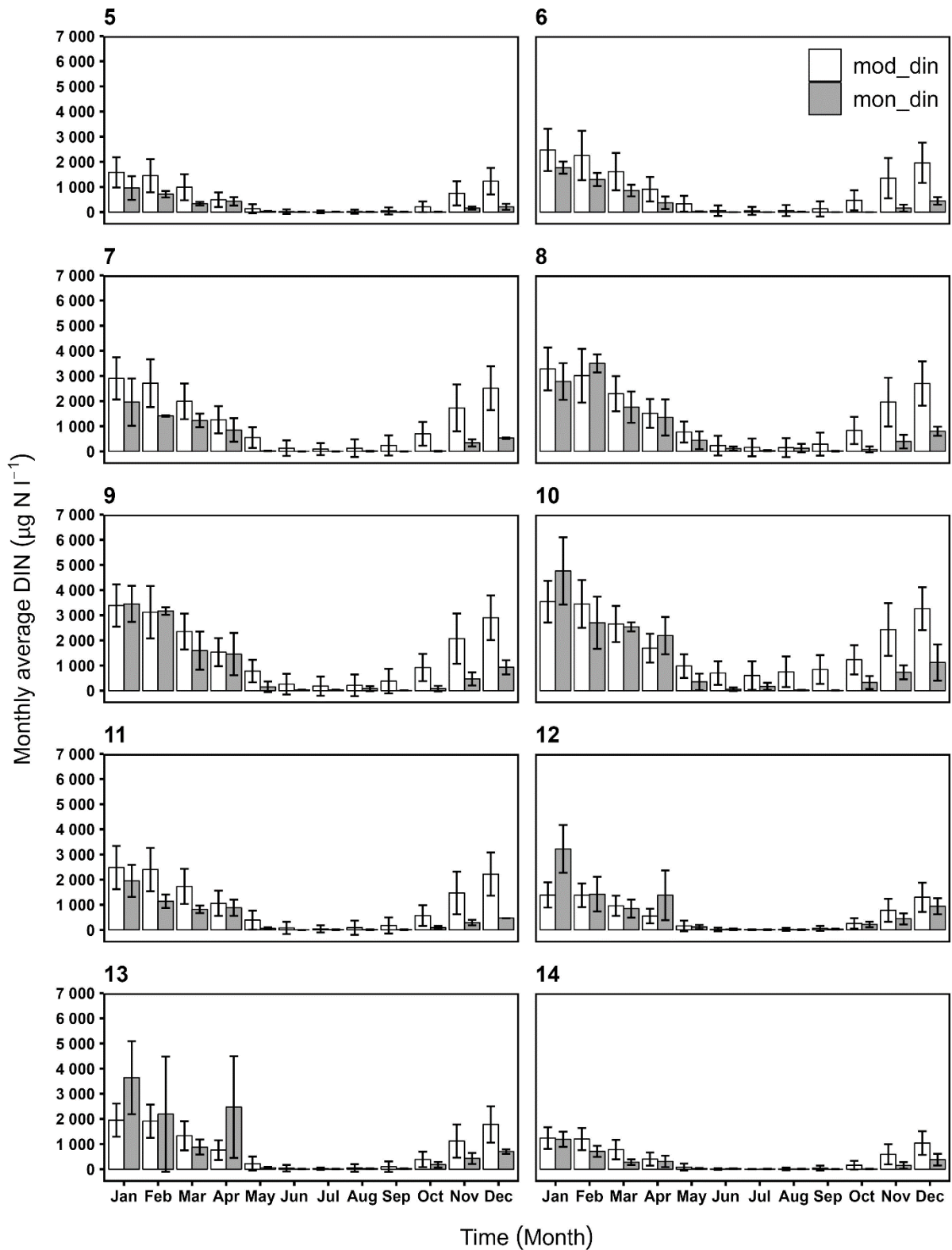

Figure 13. Odense Fjord, Denmark. Simulated and measured concentrations of DIN in Odense Inner Fjord as defined by the WFD. Notice that modelled data are from 2002-2026 whereas monitored data are from June 2002-2023.

Appendix D – Outer Fjord stations (DIN)

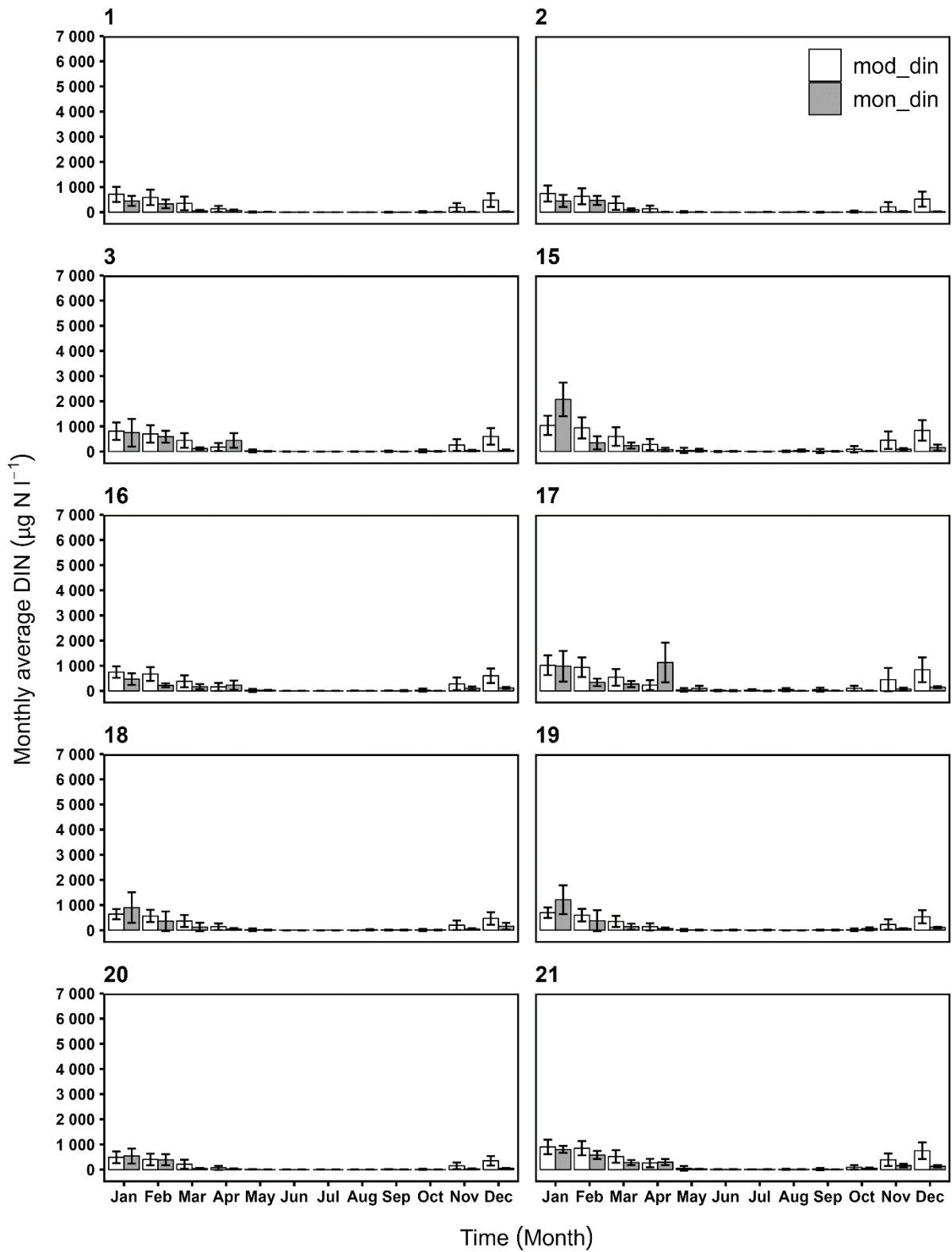

Figure 14. Odense Fjord, Denmark. Simulated and measured concentrations of DIN in Odense Outer Fjord as defined by the WFD. Notice that modelled data are from 2002-2026 whereas monitored data are from June 2002-2023.

Appendix E – Inner Fjord stations (DIP)

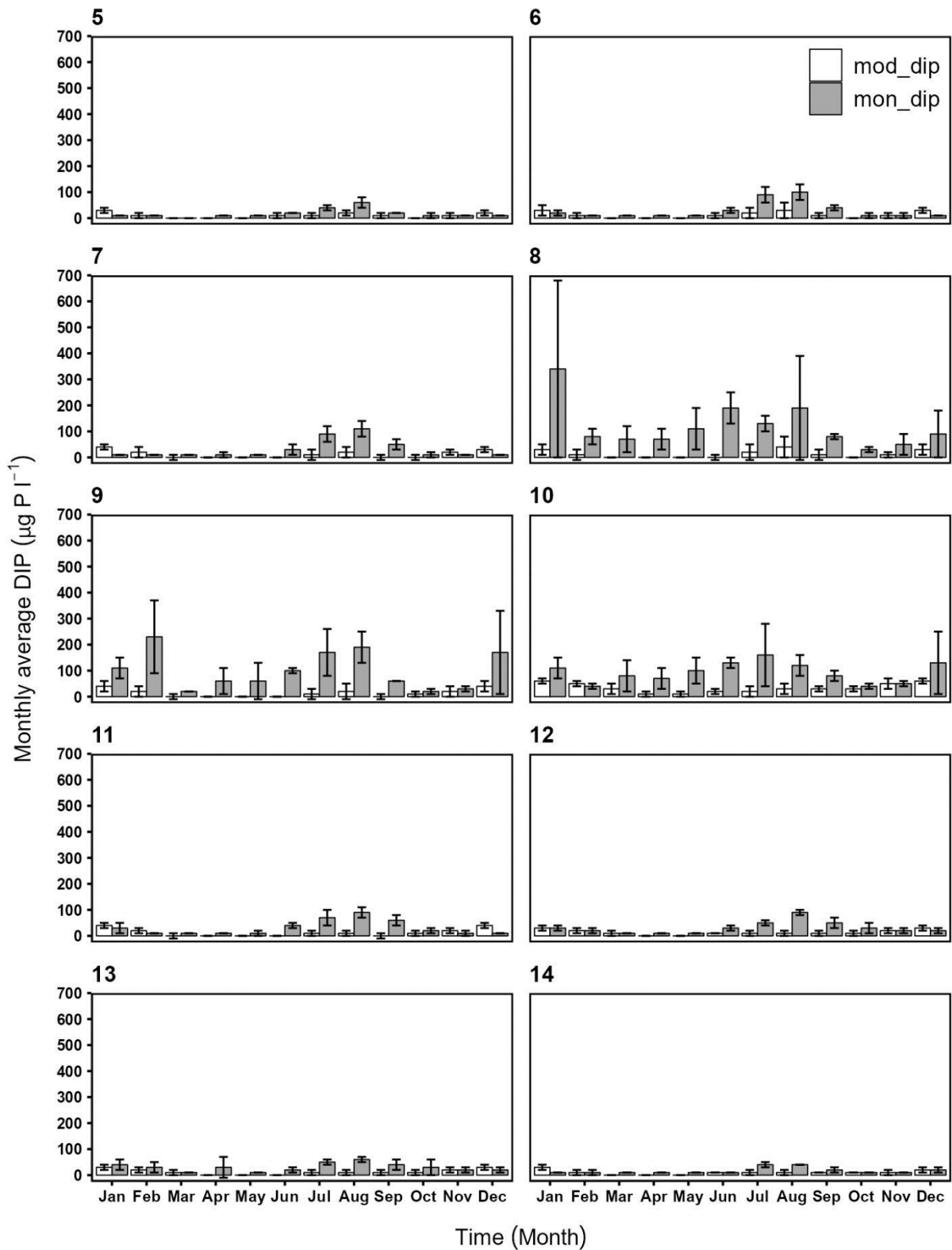

Figure 15. Odense Fjord, Denmark. Simulated and measured concentrations of DIP in Odense Outer Fjord as defined by the WFD. Notice that modelled data are from 2002-2026 whereas monitored data are from June 2002-2023.

Appendix F – Outer Fjord stations (DIP)

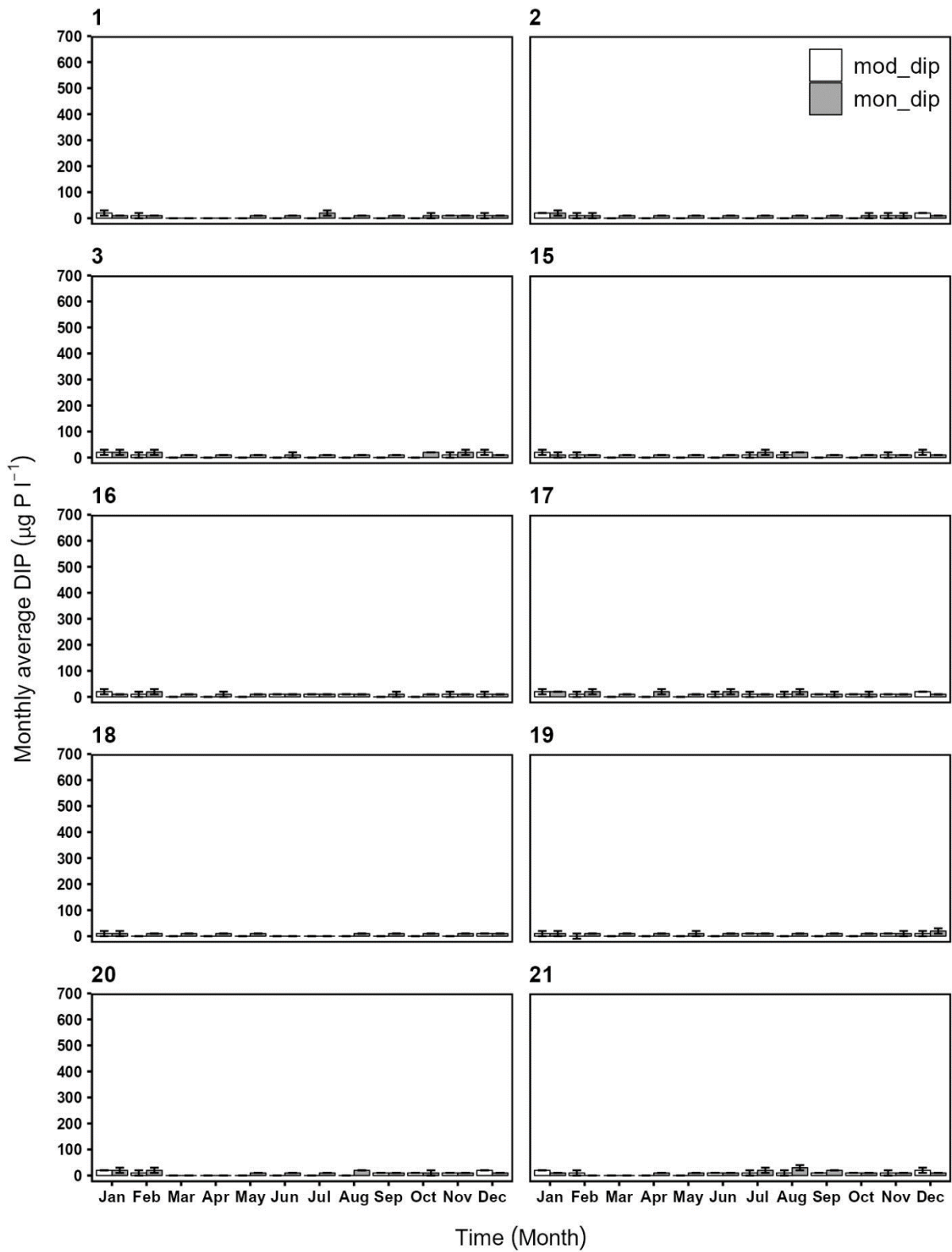

Figure 16. Odense Fjord, Denmark. Simulated and measured concentrations of DIP in Odense Outer Fjord as defined by the WFD. Notice that modelled data are from 2002-2026 whereas monitored data are from June 2002-2023.

Fjordmodel og scenarieanalyser (AP 1.4 og 1.6)

Model development and Scenario Analysis

Dansk resumé

Som en del af arbejdet i Kystvandsrådet for Odense Fjord er DHI A/S blevet bedt om at opstille modelscenarier, udviklet igennem diskussioner i Kystvandsrådet og oplandsmodellering i parallelle arbejdsgrupper.

Modelscenarierne er baseret på en tidligere mekanistisk model for hele Odense Fjord, udviklet og anvendt under arbejdet med vandområdeplanerne 2021-2027 (DHI 2019a og DHI 2020).

I arbejdet under Kystvandsrådet er der blevet udviklet tre modelscenarier, som efterfølgende er blevet afviklet i den mekanistiske model for Odense Fjord:

1. Et modelscenario (S1), hvor der er implementeret vådområder i alle potentielle egnede lokaliteter i oplandet til Odense Fjord. Dette scenario bygger på resultaterne af en workshop, som blev afviklet i efteråret 2023.
2. Et modelscenario (S2) med reduktioner på renseanlæg i oplandet til Odense Fjord.
3. Et modelscenario (S3), som kombinerer de to ovenstående scenarier, og introducerer en yderligere reduktion på 14% i de årlige TP-tilførsler og implementering af minivådområder i alle egnede arealer.

Resultaterne fra modelanalysen viser en stor effekt af TN-reduktionerne fra S1 og S3, men også nogen effekt af at rense mere på renseanlæg (S2). Samlet set vurderes det, at S1 og S3 kan bringe fjorden i god økologisk tilstand, hvis realiseret, og at S2 bidrager med forbedringer i fx S3.

Ydermere viser modelanalysen, at især koncentrationer af uorganisk kvælstof (DIN) reduceres betydeligt, og til et niveau, hvor større dele af især Odense Fjord, ydre, må forventes at kunne bringes i en tilstand, hvor naturgenopretningstiltag, som fx ålegræstransplantering, vil kunne indgå i den samlede forbedring af fjordens økologiske tilstand.

Introduction

As part of the work commissioned to Kystvandsrådet for Odense Fjord, DHI A/S was asked to set up model scenarios, developed through discussions in the Kystvandsråd, and model scenarios developed in parallel work packages.

The model scenarios are based on an already developed mechanistic model for Odense Fjord, developed and used during the work with the River Basin Management Plans (RBMP) 2021-2027 (DHI 2019a and DHI 2020). This report briefly describes the model, scenarios, method, and results for the Kystvandsråds recommendations going forward.

Model development

The mechanistic model used for the scenario analysis in the preparatory work carried out in agreement with the Kystvandsråd is based on the hydrodynamic model (DHI 2019) and biogeochemical

(ecological) model (DHI 2020), which have been developed by DHI and used in the work behind the RBMP 2021-2027.

Mechanistic models enable dynamic descriptions of biogeochemistry (ecosystems) and interactions between natural influences and man-made pressures, such as e.g. nutrient loads. Therefore, mechanistic models can be used to predict changes in specific parameters, such as for example, summer chlorophyll-a concentrations, due to climatic changes or changes in nutrient loads.

A number of different factors, such as water exchange, stratification, water temperature, nutrient availability, sediment characteristics, structure of the food web, etc, determine the ecological conditions in marine waters. In addition, a number of anthropogenic factors, such as nutrient loads, fishing, etc., also impact the ecosystem and the ecological status.

In the following the models are described in short. See DHI (2019a) and (DHI 2020) for a more detailed description of the model setup and model validation.

The model complex for the Odense Fjord, including the two water bodies Odense Fjord, Seden Strand (water body no 93), and Odense Fjord, ydre (water body no 92) comprise three models:

- A hydrodynamic model
- A wave model
- A biogeochemical model

The 3D hydrodynamic model describes the physical system: Water level, current, salinity, and water temperature. Subsequently, the biogeochemical (ecosystem) model is developed, describing the controlling biogeochemical pelagic and benthic parameters and processes such as phytoplankton, dissolved oxygen, primary production, etc. A wave model is also used to describe the physical pressure from waves on the seabed (resuspension) and benthic vegetation, including eelgrass. The model structure is modular, meaning the hydrodynamic model is developed independently of the biogeochemical model.

The three models are based on the modelling software MIKE and, therefore, contain a hydrodynamic model, MIKE 3 HD FM, a wave model (MIKE SW) and a biogeochemical model built in the MIKE ECO Lab. The entire model complex is based on a flexible mesh approach.

Hydrodynamic model development

The hydrodynamic model is based on the modelling software MIKE 3 HD FM (version 2017) developed by DHI. MIKE 3 HD FM is based on a flexible mesh approach and has been designed for applications within oceanographic, coastal, and estuarine environments.

The system is based on the numerical solution of the three-dimensional (3D) incompressible Reynolds averaged Navier-Stokes equations invoking the assumptions of Boussinesq and hydrostatic pressure. The model consists of continuity, momentum, temperature, salinity and density equations, and it is closed by a turbulent closure scheme. The free surface is taken into account using a sigma-coordinate transformation approach. The scientific documentation of MIKE 3 HD FM is given in DHI (2017).

Introduction

The model setup comprises the model domain, establishing the model mesh, preparing the model forcings in terms of open boundary conditions, atmospheric forcing and freshwater inflows, preparing the initial conditions and setting up the model.

For the present project, the model is set up for the period 2002-2016, which means that all model forcings need to cover this period. The model results are analyzed for the last five years of the modelling period to ensure that changes in e.g. nutrient loads are fully reflected in the model.

Model domain

The model domain is determined based on the area of interest and the corresponding area of influence, including the location of the open boundaries.

For the Odense Fjord model, the selection of the model domain is straightforward since Odense Fjord is an estuary with only one open boundary towards Kattegat. The model covers the entire Odense Fjord and consists of two legislative water bodies: The outer fjord (92) and the inner fjord (93).

Generally, Odense Fjord is shallow ($< 2\text{m}$), but in and around the central channel, the depth is up to 10m. The water is usually well mixed, but periodical stratification in the deeper parts of the fjord can be observed.

The model mesh is the representation of the model domain. More specifically, the model mesh defines the model area, the location of the open boundaries, the land-water boundaries, the horizontal and vertical model resolution (discretization), and the water depths (bathymetry) of the model. The following sections describe the details of the horizontal and vertical model mesh.

Horizontal mesh

For the Odense Fjord model, the majority of the area is covered by an unstructured triangular mesh. In the innermost part of the fjord and Odense River, quadrangular elements were used to direct the water flow. ETRS-1989-UTM-32 gives the map projection.

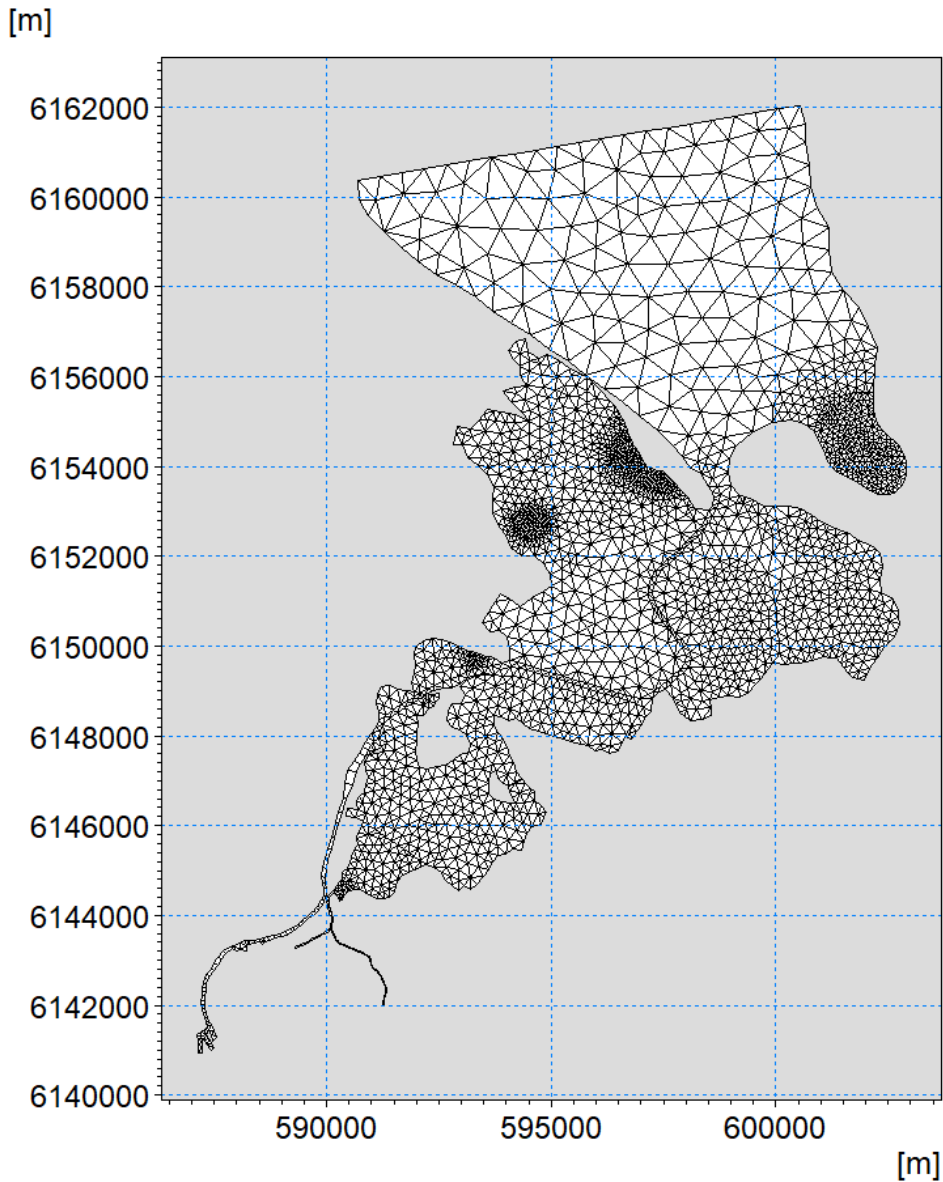

Figure 0-1 Odense Fjord mesh.

The horizontal resolution varies gradually from 150-200m to 1000m. Areas important for eelgrass growth/restoration have higher resolution (e.g. Engso Dybet) or in areas with complicated flows (e.g. innermost fjord and Odense River)

The model bathymetry shown in Figure 0-2 is based on satellite-derived bathymetry data by GRAS (in the shallow areas up to approximately 0.75m depth) (DHI 2019b) and a combination of C-Map navigation chart data and the Danish Coastal Authority survey data for the rest. The vertical datum of the bathymetry is DVR90.

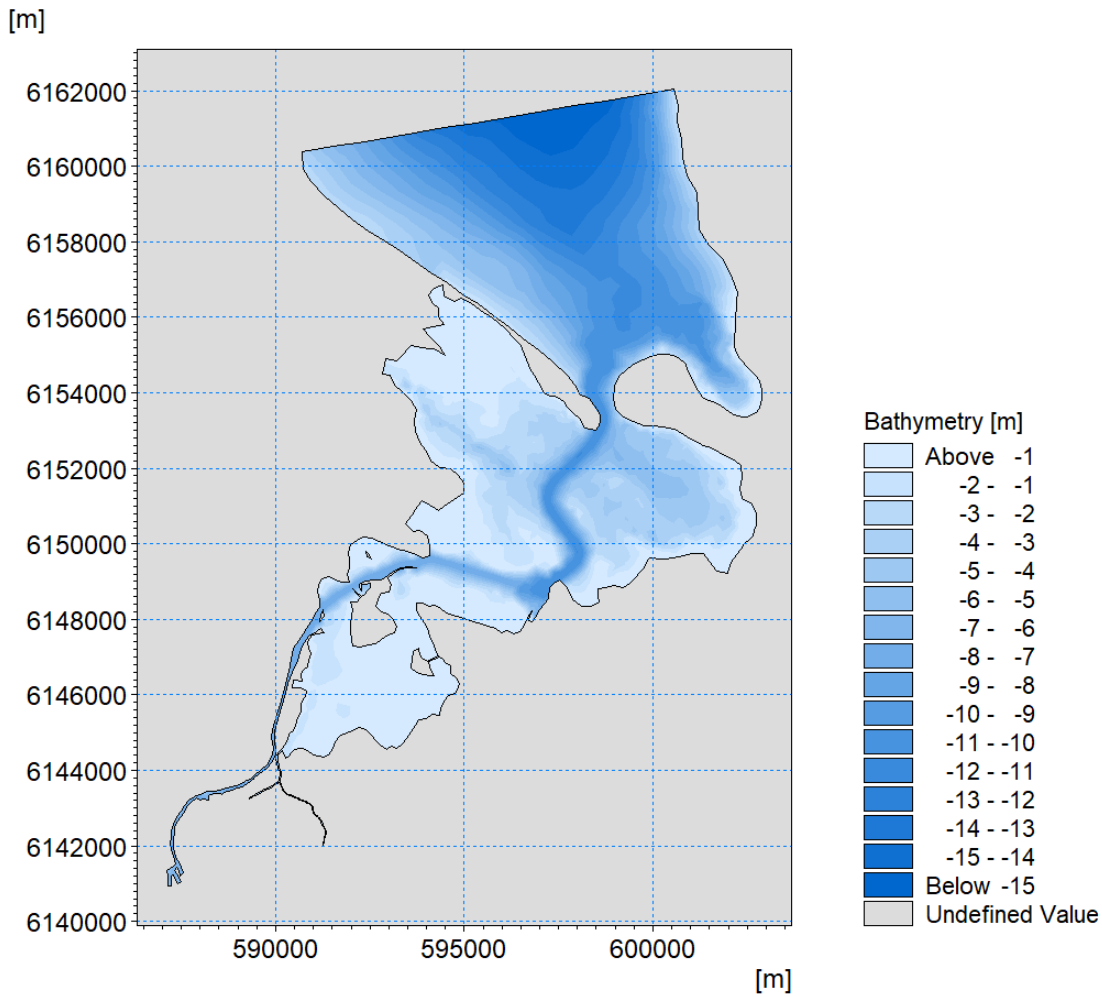

Figure 0-2 Odense Fjord Bathymetry.

Vertical mesh

The vertical mesh is structured and consists of a combination of sigma- and z-layers. In the Odense Fjord model, a total of 21 model layers are applied. The water column from the surface to -3m below mean sea level (MSL) is resolved by three sigma-layers, and the water column below is resolved by up to 18 z-layers, with a layer thickness of 1m.

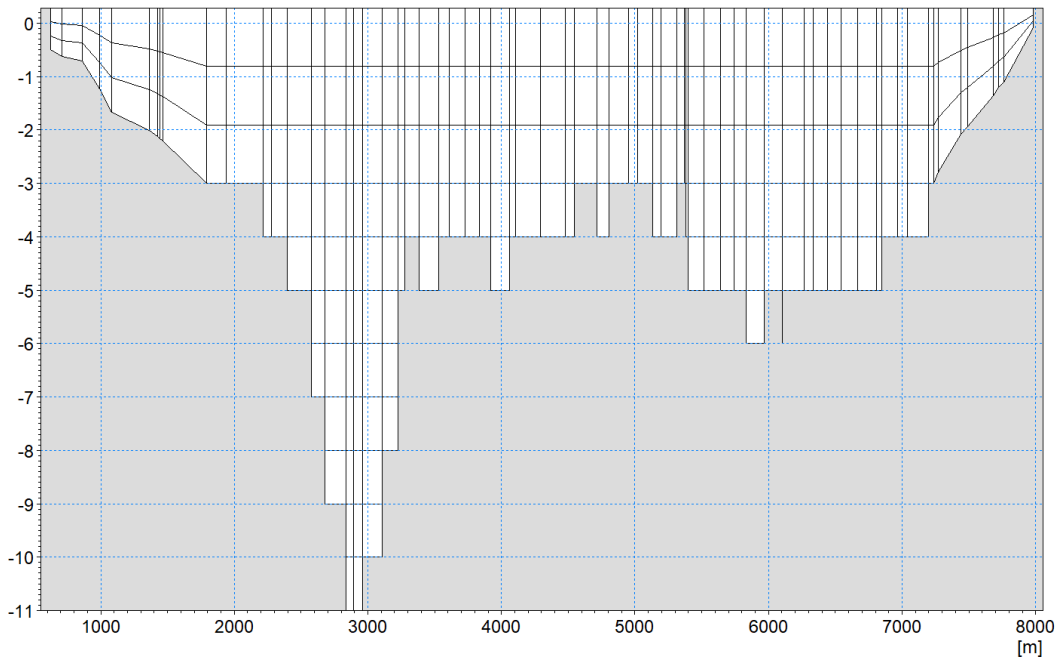

Figure 0-3 Example of a cross-section in Odense fjord showing the vertical model mesh consisting of three sigma layers down to -3m, z-layers of -1m resolution down to local depth (here down to the local depth of -11m)

Model forcings

Open boundary conditions

The model has an open boundary towards Kattegat, which is located to the northeast of the model. At this boundary, the time variation of water levels, water temperature and salinity are specified. The water levels were extracted from DHI's existing regional model, whereas measured water temperature and salinity profiles from Station FYN6940622 were used to specify the time-varying water temperature and salinity profiles at the boundary.

Atmospheric forcing

The applied atmospheric forcings consist of:

- Wind speed/direction
- Air temperature
- Relative humidity
- Precipitation
- Clearness

Hourly time series of measured wind speed/direction, air temperature and relative humidity from station Odense Airport (Station 612000) were used for the whole simulation period, while air temperature and relative humidity used data from Odense Airport station from 2002 to 2012 and StormGeo from 2013 to 2017.

Measured time series of daily precipitation from Agernæs (period 2002 to 2011) and Odense Airport (from 2011 to 2013) together with measured hourly data of clearness (cloud cover) from Odense Airport were used. For the period 2013 to 2016, hourly time series of model data extracted from meteorological fields provided by StormGeo were used.

Freshwater sources

The Odense Fjord model includes sources representing the freshwater run-off to the fjord. The freshwater data are available based on data from DCE (Aarhus University) on a 4th order water body level, and these data were distributed based on catchment area and knowledge of specific point sources and included in the model according to Figure 0-4.

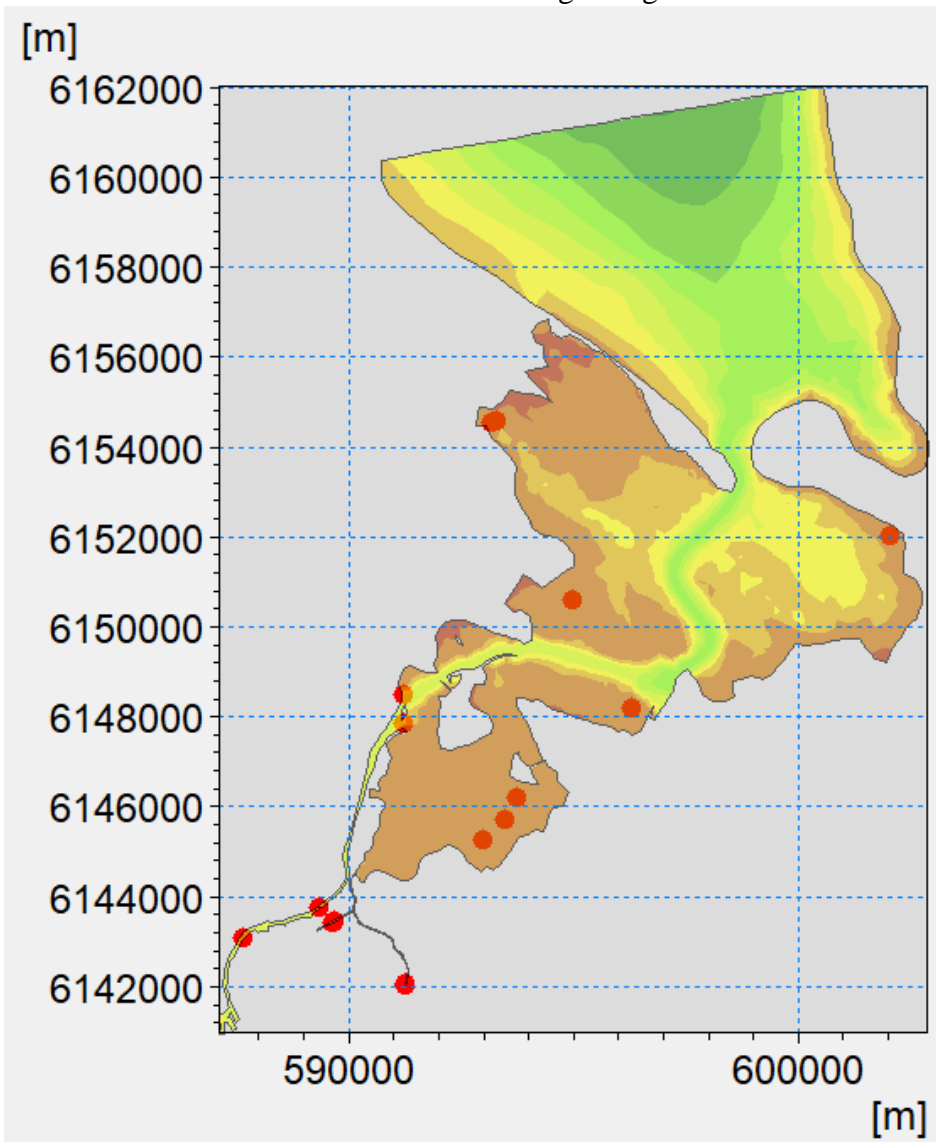

Figure 0-4 Distribution of freshwater sources applied in the Odense Fjord model.

Fynsværket

The Odense Fjord model includes the discharge of cooling water from Fynsværket. Information about volume ($\text{m}^3 \text{s}^{-1}$) and water temperature is based on data from Fynsværket covering the period from 2002-2016.

Initial conditions

The 3D model requires initial conditions of all prognostic parameters, including water level, currents, salinity, sea temperature, etc. Water level and current velocity are specified as MSL and zero velocity, respectively, ('cold start') as the model spin-up is short, meaning the currents and water levels adjust to the forcings within a short time frame and do not impact the analysis period.

For the 3D initial salinity and sea temperature fields, however, the spin-up is longer, and accordingly, the initial fields of these two parameters are provided as input to the model. Monitoring data from stations within Odense Fjord are used to create the initial temperature and salinity fields.

Model calibration

The hydrodynamic model is calibrated and validated according to measurements from 2002-2016, see DHI 2019a for details.

Biogeochemical model development

The biogeochemical model is based on the 3D modelling software MIKE 3 HD FM (version 2017) developed by DHI together with the numerical 3D equation solver MIKE ECO Lab to describe the relevant biogeochemical processes in the modelling system.

The main components and processes determining the status of the water quality and the response in the ecosystem (e.g. changes in eelgrass biomass) are included in the biogeochemical model. They are based on external factors (meteorology and nutrient supply). The model describes the turnover of organic material and nutrients, both in the pelagic (water column) and the benthic phase (seabed or sediment). The pelagic phase includes phytoplankton and nutrients, and the benthic department covers sediment pools of nutrients and the exchange of nutrients between the sediment and water phases. Furthermore, the benthic part of the model describes the biomass and growth of benthic vegetation at the seabed. The mechanisms behind the biogeochemical model and the ECO Lab templates used are described in Erichsen & Birkeland (2019).

Open boundary conditions

The Odense Fjord model has one open boundary towards the Danish straits located to the northeast of the model. Documentation of boundary conditions for the development of the biogeochemical model is given in Erichsen & Birkeland (2020).

Forcings

Data on solar radiation are calculated from clearness percentages and applied as a temporally varying forcing.

AU provides area-distributed atmospheric deposition of nitrogen (N), Department of Environmental Science, and aligned with HELCOM depositions (see Erichsen & Birkeland 2020).

Dynamic bottom shear stress information is needed to estimate suspended sediment concentrations. Wave parameters from a Spectral Wave model are included as model forcing, including significant wave height, wave period and mean wave direction, together with current conditions from the hydrodynamic model results.

The technical report DHI (2020) gives documentation on model forcing.

Sources

The Odense Fjord model includes sources with land-based nutrient loadings via streams together with the intake and discharge of cooling water from Fynsværket. In Figure 0-4, the location of the sources is shown. Freshwater run-off from land is included in the hydrodynamic module.

The model sources are specified as time series with daily varying loadings of inorganic and organic nutrients, including also total nitrogen (TN) and total phosphorus (TP). The land-based nutrient loadings are based on DCE/AU, Department of Bioscience data on a 4th order water body level.

Fynsværket's cooling water intake and discharge do not contribute to any nutrients to the fjord system.

More details are included in DHI (2020).

Model calibration

The biogeochemical model is calibrated and validated according to measurements in the period 2002-2016; see DHI (2020) for details. In addition, the model has been validated against measurements from 2022 and 2023 monitored as part of the Odense Fjord Samarbejde. This validation has been reported to the Kystvandsråd in a separate document: "Kystvandsråd WP1.3 – Model validation".

Model scenarios

As part of the Danish Environmental Protection Agency's (DEPA) projects behind the RBMP 2021-2027, it has previously been determined that the water bodies Odense Fjord, Seden Strand, and Odense Fjord, ydre, are sensitive to phosphorus and the amount of nutrients that are discharged, especially during the growth season (Erichsen et al. 2021a).

The work behind the developed scenarios was carried out in a parallel work package (WP 2.9), and the results are described in more detail in Larsen et al. (in prep.).

In summary, the following scenarios have been decided and implemented in the mechanistic model for Odense Fjord, Seden Strand, and Odense Fjord, ydre:

1. A wetland scenario (S1): As part of the work in the Kystvandsråd, a workshop was carried out selecting suitable areas for wetlands in the catchment to Odense Fjord. The workshop identified the maximum potential area for wetlands, and in WP 2.9, a SWAT model was executed, including the daily reductions based on implementing two variations of wetland areas (see Larsen et al. (in prep.) for details). The results of the swat analysis are shown in Figure 0-5.

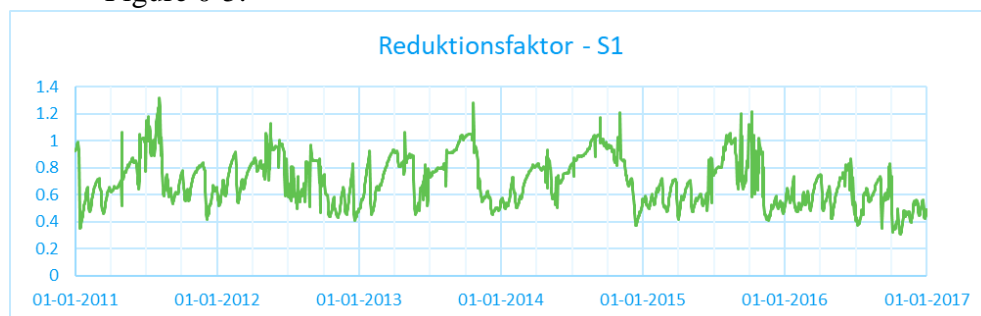

Figure 0-5 Daily reductions based on scenario 1, including wetlands as the only measure for reducing the TN-load. A factor of 1.0 equals no reductions, whereas a factor of 0.6 equals a 40% reduction.

2. A wastewater treatment plant (WWTP) scenario (S2): Additional reductions at the major WWTPs in the catchments were introduced.
3. A combined scenario (S3): This scenario combined S1 and S2 and introduced another 14% P-reduction equally distributed over the years and the introduction of constructed wetlands in all suitable locations (see Larsen et al. (in prep.)) for details.

The results from the different scenarios are included in Figure 0-6 and Figure 0-7, whereas the summary of the scenarios is included in Table 0-1.

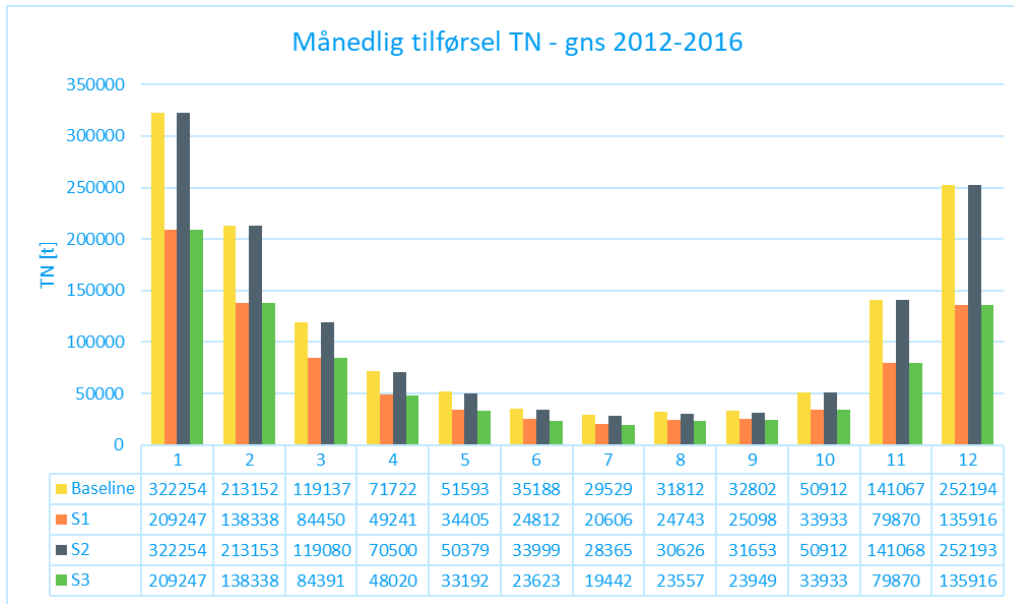

Figure 0-6 Monthly TN loads to Odense Fjord, Seden Strand. The large reductions are observed for S1, whereas S2 only implies minor reductions, and S3 displays the combined scenario. Average for 2012-2016.

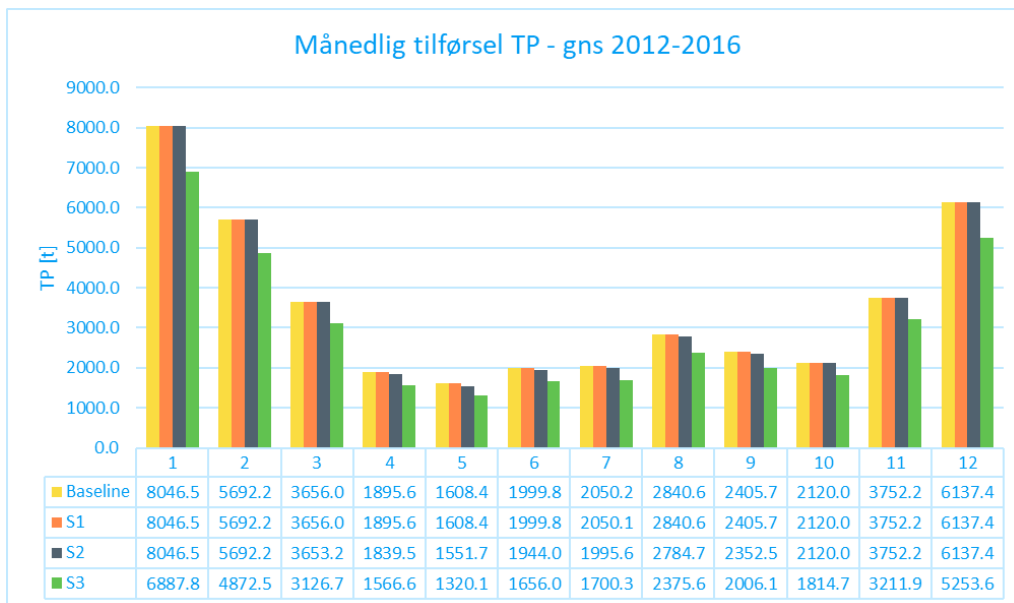

Figure 0-7 Monthly TP loads to Odense Fjord, Seden Strand. The large reductions are observed for S3, where the 14% reductions are included. Average for 2012-2016.

Table 0-1 Summary of scenario loads (top rows) and the relative difference to the status loads (bottom rows). Average for 2012-2016.

Loads	Status TN [tons N]	Status TP [tons P]	S1 TN [tons N]	S1 TP [tons P]	S2 TN [tons N]	S2 TP [tons P]	S3 TN [tons N]	S3 TP [tons P]
Odense Fjord, ydre	1438	44.5	913	44.5	1431	44.2	906	37.8
Odense Fjord, Seden Strand	1366	42.6	868	42.6	1359	42.2	861	36.1
Relative difference	Status TN	Status TP	S1 TN	S1 TP	S2 TN	S2 TP	S3 TN	S4 TP
Odense Fjord, ydre	1	1	0.63	1	1.00	0.99	0.63	0.85
Odense Fjord, Seden Strand	1	1	0.64	1	0.99	0.99	0.63	0.85

Method

In Section 0, the model scenarios are briefly described. These scenarios have been completed, and model results have been prepared to be able to assess the effects on summer chlorophyll-a and K_d in the growth season calculated as described in Erichsen et al. (2021b).

In Erichsen et al. (2021b), model scenarios are used in the RBMP 2021-2027 work to calculate a dose-response for the two indicators summer chlorophyll-a and K_d in the growth season. In Erichsen et al. (2021b), the dose-response is calculated in relation to changes in the annual load of TN and TP based on the assumption that a reduction in the annual load is distributed in % evenly over the year. This means an annual reduction of 10% in TN load is divided by a 10% reduction in the January load, 10% in the February load, etc. The dose-response and associated relationships between load and summer chlorophyll-a are shown in Figure 0-8.

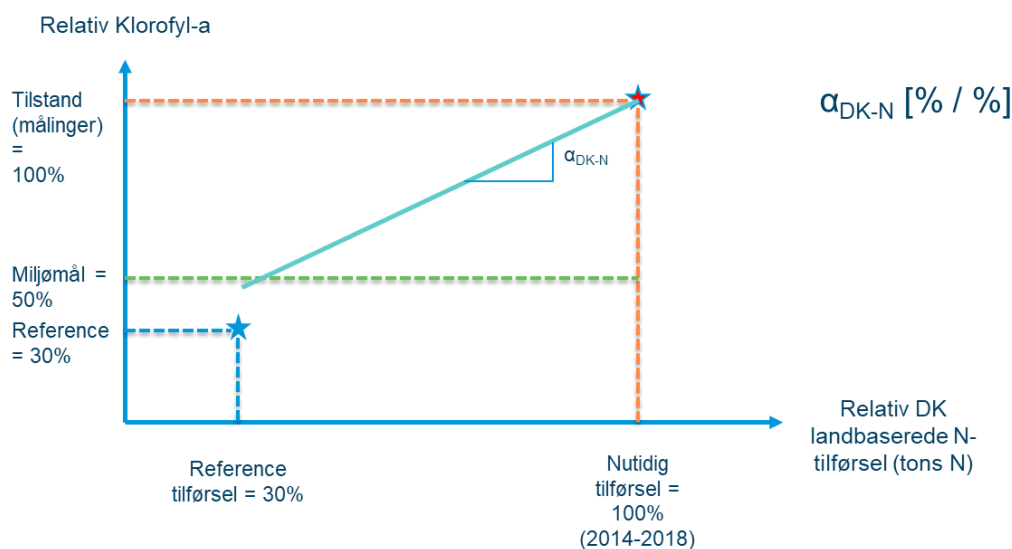

Figure 0-8 Schematic illustration of dose-response calculation. Note that the figure only describes relative differences. Hence, current load and indicator status make up 100%, while reductions are calculated relative to today's load and status. Therefore, the figure example shows the dose-response unit has % change in summer chlorophyll-a concentration per % change in TN load.

The description in Erichsen et al. (2021b) relates to changes in TN and TP annual loads and are included in the overall estimation of maximum allowable inputs (MAI) in the Danish marine water bodies, but it is only reductions in nitrogen loads, which are estimated as actual MAIs and corresponding need for reductions.

Similarly, as part of the work behind the Kystvandsråd, a similar methodology has been developed for the water bodies Odense Fjord, Seden Strand, and Odense Fjord, ydre. Here, results from the scenario runs are used to calculate an annual equivalent (or exchange rate) between specific P-reductions and year-round TN load.

Annual equivalents

To evaluate the effectiveness of reducing TP inputs, the effects on the indicators summer chlorophyll-a and K_d in the growth season are compared with corresponding model results behind the RBMP 2021-2027.

In Erichsen et al. (2021b), year-round reductions were calculated as relative changes in nutrient inputs and effects on the indicators. In relation to the work behind the Kystvandsråd, this method is adjusted so that it is still calculated relative to the indicators, while the changes in loads are now calculated in absolute reductions, see Figure 0-9 and Figure 0-10.

The unit on the dose-response curve is changed to, for example, a %- change in summer chlorophyll-a concentration per ton change in TN load and a %-change in summer chlorophyll-a concentration per ton change in TP load, depending on the nutrient in focus.

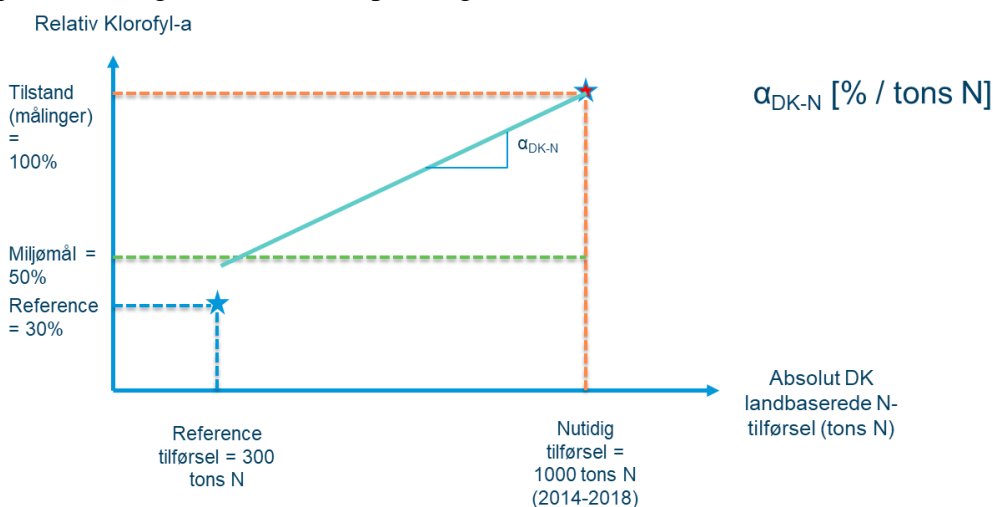

Figure 0-9 Schematic illustration of dose-response calculation. Note that the figure describes relative indicator differences while the load is in absolute reductions. Therefore, the dose-response unit has a %-change in summer chlorophyll-a concentration per tons change in TN load in the figure example.

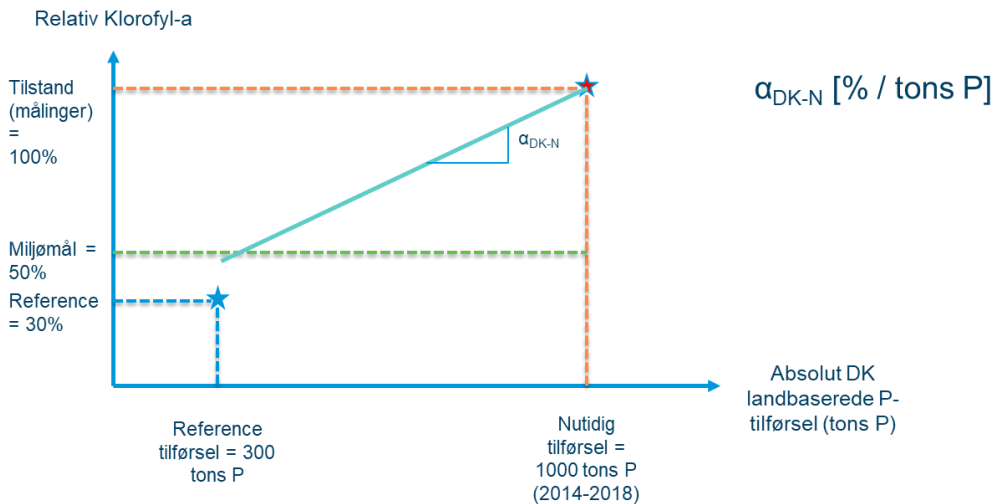

Figure 0-10 Schematic illustration of dose-response calculation. Note that the figure describes relative indicator differences while the load is in absolute reductions. Therefore, the dose-response unit has a %-change in summer chlorophyll-a concentration per per tons change in TP load in the figure example.

In this study, we have run scenarios as described in section 0, and thus, we can compare the effects of reducing year-round TN-loads (% equal reductions) and corresponding slopes between reductions in TN (Figure 0-9) and slopes in the actual reductions suggest in this project (Figure 0-9/Figure 0-10) and calculate a TN equivalent for year-round TN loads:

$$\text{Equivalent} = \alpha_{\text{DK-N}} / \alpha_{\text{DK-N}}$$

This equivalent can be used in the Kystvandsråds evaluation of the selection of measures to be implemented in the catchment as part of the final RBMP for Odense Fjord.

Results and conclusions

Model results - indicators

The results of the model scenarios are presented in this section as a relative difference between the scenarios and the model results representing the status. The results based on the two indicators, summer chlorophyll-a (May to September) and Secchi depth during the growth season (Marts to September), are included in Figure 0-11 to Figure 0-13.

There is an apparent reduction in summer chlorophyll-a (between 30-50% reduction) in S1 and S3, where the effects of the large TN reductions from the wetland implementations govern the reductions. Also, in S2 some reductions (5-10%) are modelled in the central part of Odense Fjord but are based on relatively small reductions.

Similar results are observed for Secchi depth, although the reductions are smaller, as Secchi depths react slower to reductions than chlorophyll-a. In S2, the results show less than 5% increase in the entire Odense Fjord.

Generally, the improvement in summer chlorophyll-a and Secchi depth will support Good Ecological Status (GES) in Odense Fjord if realized.

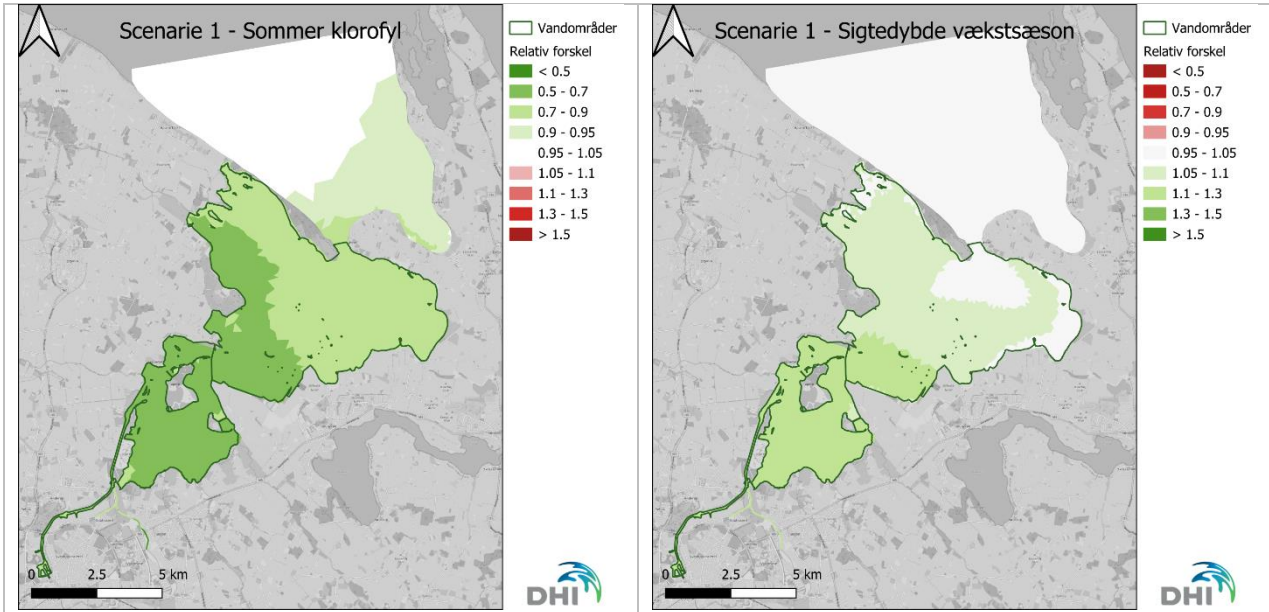

Relative difference between summer chlorophyll-a (left) and Secchi depth (right) in S1 compared to the status situation. The value 1,0 indicates no change, whereas a value of 0.7 indicates a 30% reduction, and a value of 1.3 indicates a 30% increase.

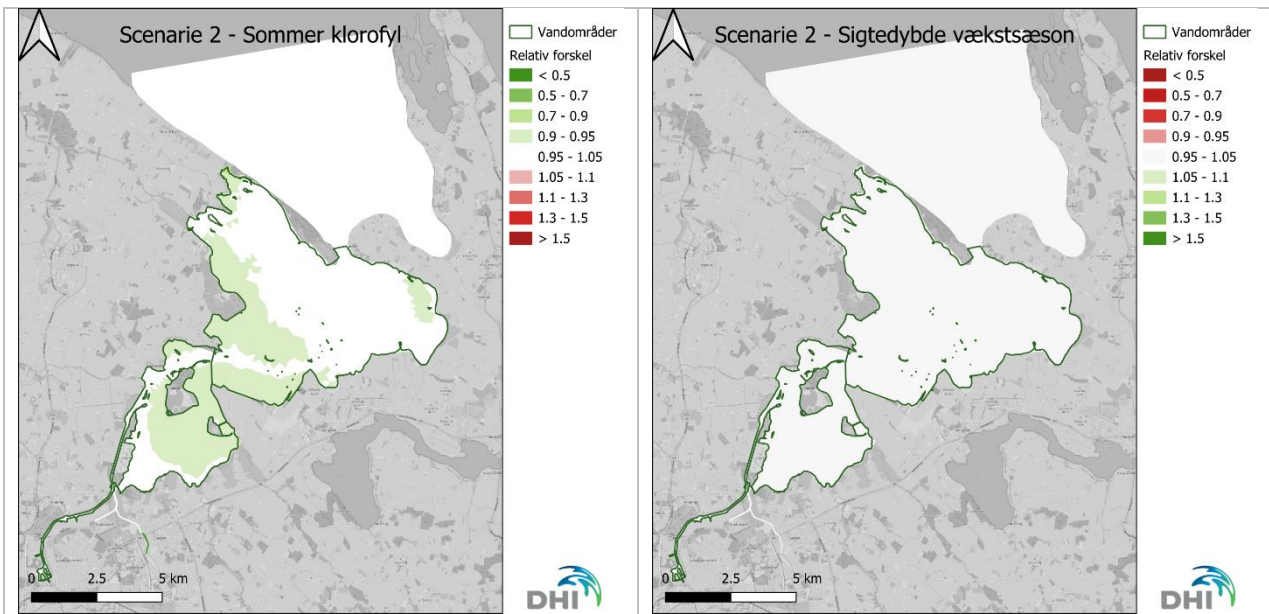

Relative difference between summer chlorophyll-a (left) and Secchi depth (right) in S2 compared to the status situation. The value 1,0 indicates no change, whereas a value of 0.7 indicates a 30% reduction, and a value of 1.3 indicates a 30% increase.

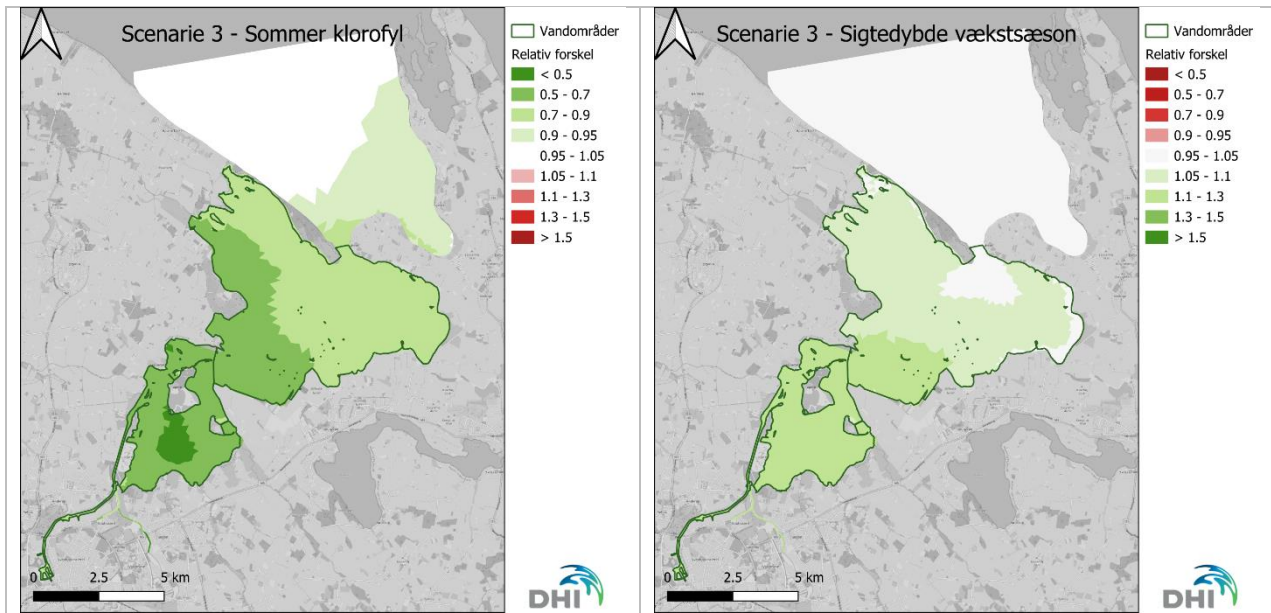

Relative difference between summer chlorophyll-a (left) and Secchi depth (right) in S3 compared to the status situation. The value 1,0 indicates no change, whereas a value of 0.7 indicates a 30% reduction, and a value of 1.3 indicates a 30% increase.

Model results – inorganic nutrients

As marine restoration is also of concern to the Kystvandsråd, similar results presented in the previous sections are included for DIN and DIP during the growth season (Marts to September). These results are included in Figure 0-14 to Figure 0-16.

In S1 and S3, the wetland reductions in TN loads clearly decrease the DIN concentrations in Odense Fjord, and the estuary concentrations decrease by more than 50%. In S2, the reductions are very modest; however, the reductions do show in summer chlorophyll-a (Figure 0-12).

Reductions in DIN are required to ensure the potential successful restoration of e.g., eelgrass meadows.

While DIN concentrations and chlorophyll-a concentrations are reduced, the pool of DIP increases, which is also very clear from the figures. The excess DIP concentrations increase even in S3, including a 14% additional TP reduction.

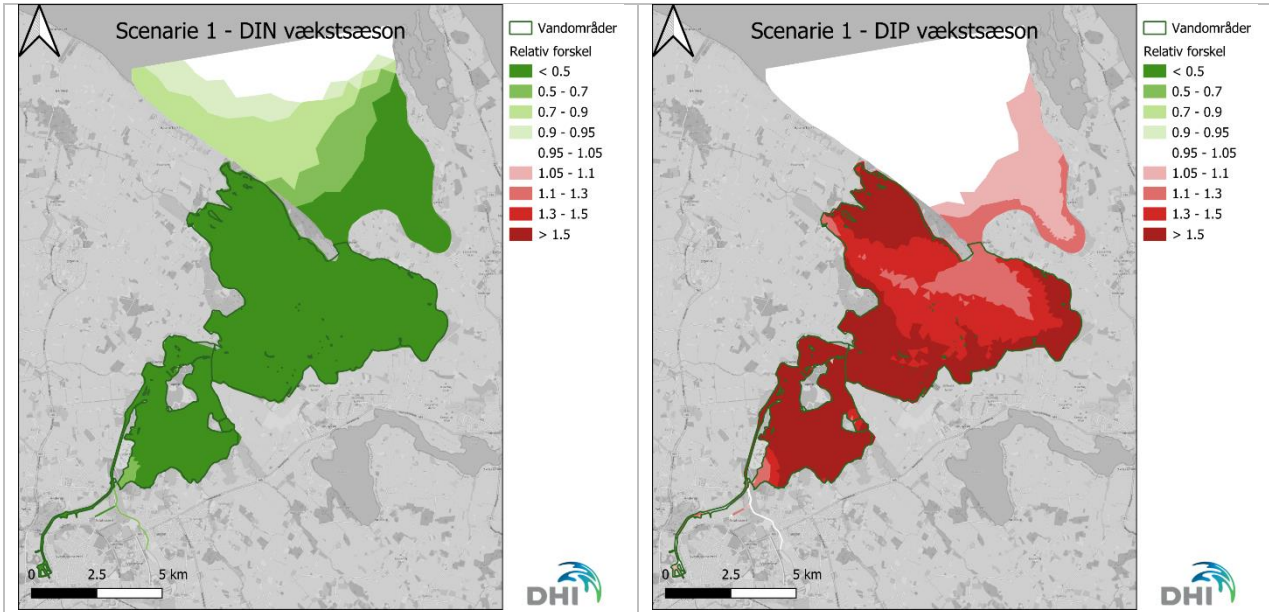

Relative difference between DIN during the growth season (Marts to September) (left) and DIP during the growth season (Marts to September) (right) in S1 compared to the status situation. The value 1,0 indicates no change, whereas a value of 0.7 indicates a 30% reduction, and a value of 1.3 indicates a 30% increase.

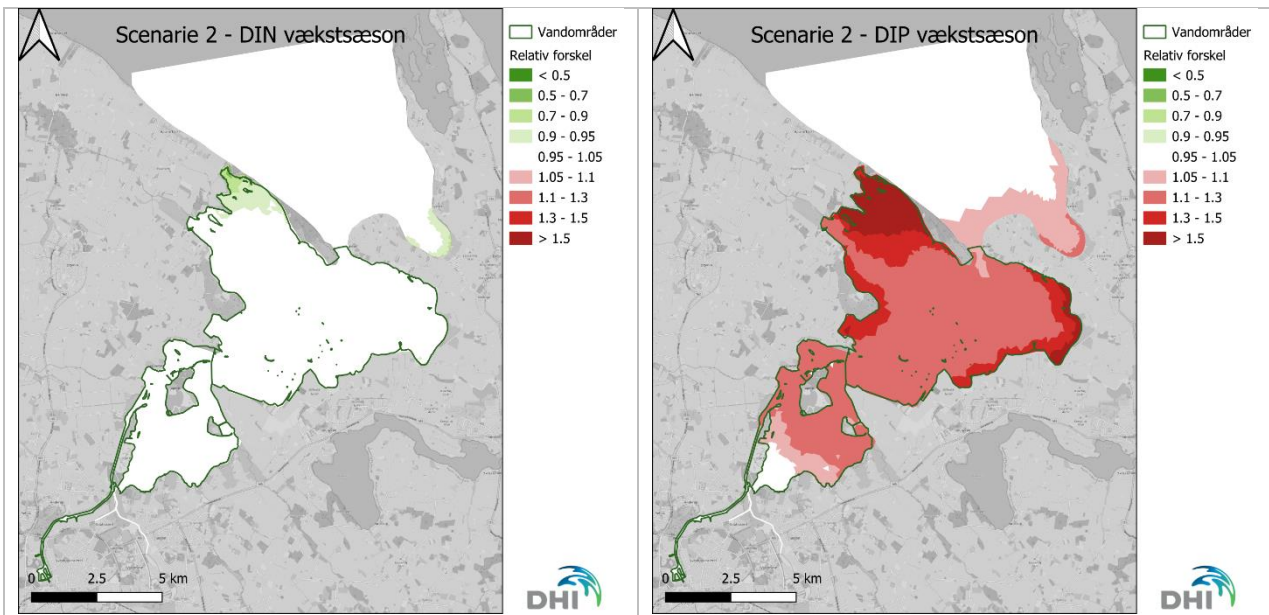

Relative difference between DIN during the growth season (Marts to September) (left) and DIP during the growth season (Marts to September) (right) in S2 compared to the status situation. The value 1,0 indicates no change, whereas a value of 0.7 indicates a 30% reduction, and a value of 1.3 indicates a 30% increase.

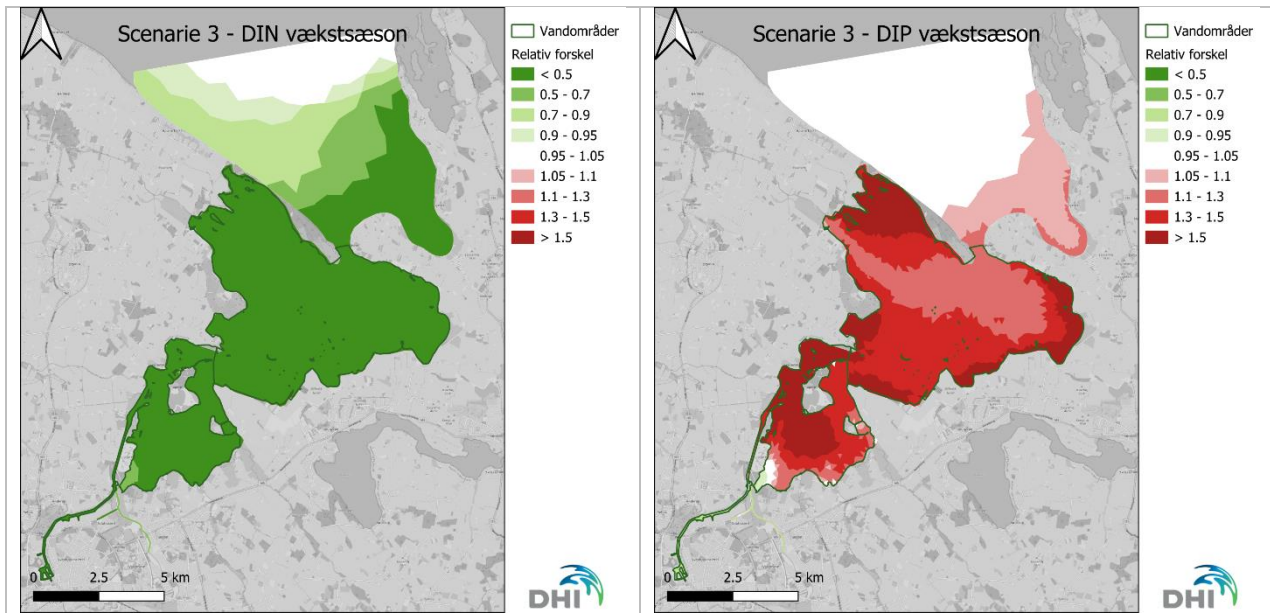

Figure 0-16

Relative difference between DIN during the growth season (Marts to September) (left) and DIP during the growth season (Marts to September) (right) in S3 compared to the status situation. The value 1,0 indicates no change, whereas a value of 0.7 indicates a 30% reduction, and a value of 1.3 indicates a 30% increase.

Local reductions and equivalents

Based on the model scenarios described in section 0 and the methodology description in section 0, scenario equivalents to year-round TN loads are calculated. The results are included in Table 0-2. It is important to emphasize that the models have been run from 2002-2016, but only model results from the last 5 years are included in the analysis. This has been done to ensure that changes in nutrient inputs from land can take effect over a number of years and thus ensure that the internal load can reach a new equilibrium.

From Table 0-2, we conclude that reductions in WWTP have a relatively higher impact on the two indicators, as the equivalent is between 9-10; why 1 ton reduction in the load from the WWTPs will impact the estuary equal to 9-10 tons reductions in year-round loads.

Similarly, we conclude that S1 has an equivalent of less than 1.0, mainly due to the larger relative reductions during winter compared to the loads during the growth season. Reductions in S1 and S3 are still large and sufficient to obtain GES, but the smaller reductions at the WWTP can provide additional benefits to the ecological status of Odense Fjord.

In addition, it is important to emphasize that local reductions to, for example, Odense Fjord, Seden Strand, and Odense Fjord, ydre, are included in reductions estimated for the water body Århus Bugt syd, Samsø og Nordlige Bælthav, why changes to Odense Fjord, Seden Strand, and Odense Fjord, ydre, can and will have consequences for reductions in this water body. This is not part of the Kystvandsråd's work but may change the results of the work reported by the Kystvandsråd.

Table 0-2 Scenario equivalents to year-round TN loads.

Vandområde	S1	S2	S3
Odense Fjord, ydre	0.65	9.58	0.77
Odense Fjord, Seden Strand	0.72	9.03	1.08

References

DHI (2017). MIKE 21 & MIKE 3 Flow Model FM. Hydrodynamic and Transport Module. Scientific Documentation (http://manuals.mikepoweredbydhi.help/2017/Coast_and_Sea/MIKE_321_FM_Scientific_Doc.pdf, link working on 12-11-2018)

DHI 2019a. Development of Mechanistic Models – Mechanistic Model for Odense Fjord – Hydrodynamic model documentation, DHI rapport, project number 11822245

DHI (2019b). Udvikling af Mekanistiske Modeller. Satellitbaseret bathymetri i Danmark. DHI Gras technical report (project no. 11822245).

DHI 2020. Development of Mechanistic Models – Mechanistic Model for Odense Fjord – Technical documentation on biogeochemical model, DHI rapport, project number 11822245

Erichsen AC & Birkeland M (2019). Development of Mechanistic Models. Short Technical Description of the Biogeochemical Models Applied for the Mechanistic Model Development. DHI rapport, project number 11822245

Erichsen AC, Nielsen SEB, Timmermann K, Højberg AL, Eriksen J & Pedersen BF (2021a). Muligheder for optimeret regulering af N- og P-tilførslen til kystvandene med fokus på tilførslen i sommerhalvåret. Analyse og kvantificering. [Development og Mechanistic Models, RBMP 2021-2027 \(au.dk\)](#)

Erichsen AV, Timmermann K, Larsen TC, Markager S & Christensen J (2021b). Application of the Danish EPA's Marine Model Complex and Development of a Method Applicable for the River Basin Management Plans 2021-2027. Conceptual Method for Estimating Maximum Allowable Inputs. [Development og Mechanistic Models, RBMP 2021-2027 \(au.dk\)](#)

Larsen M et al. (in prep. – in Danish). SWAT+ model – Scenarier og reduktionsbehov

Vurdering af marine virkemidler og omkostninger ved restaurering (AP 1.5 og AP 3.2)

Marine mitigation tools in Odense fjord

Paula Canal-Vergés, Mikkel K. Lees, Frederik H Hansen, Rune Steinfurth, Timi Banke & Mogens R. Flindt

Dansk resumé

Dette afsnit beskriver anvendelsen af marine virkemidler i Odense fjord. Disse marine virkemidler er reduktion af den landbaserede næringssaltsbelastning, ålegræs genopretning, sand-capping samt sten- og biogene rev. Forskellige metoder har været i spil i forbindelse med ålegræs restaurering men efter adskillige videnskabelige studier er udplantning af ålegræsskud forankret med søm fundet bedst egnet til forholdet i kystnære danske vandområder. Ved assisteret ålegræs restaurering foretages først en screening for egnede områder til udplantning. Dette gøres med model/GIS værktøjer efterfulgt af en drone/orthofoto analyse af de af den økologiske models udpegede områder. Herefter foretages dykkerobservationer af områderne. Hvis der findes egnede områder på baggrund af model/GIS analyse, Drone/orthofoto analyse og dykkerobservationer kan der foretages testudplantninger som skal afsøge den endelige egnethed af de udvalgte områder. Efter et års monitorering af testudplantninger kan der i særligt egnede områder som udviser positiv tilvækst af ålegræsskud foretages stor-skala udplantninger. Stor-skala udplantninger følges med tæt monitorering for således at kvantificere de yderligere økosystemtjenester der opstår ved en sådan ålegræsrestaurering. Dette flow blev af SDU anvendt i Odense Fjord i sommeren 2022 resulterende i 12 stationer til testudplantning af ålegræsskud. 2 af de 12 udplantninger overlevede gennem vinteren 2022-2023; én station i inderfjorden (#2) og én station (#7) i den østlige del af yderfjorden nær Bregør (Figure 17). Alle andre stationer overlevede ikke pga. multipelt stress fra flere parametre (Table 3). Station 7 i yderfjorden viser positiv tilvækst hvorimod station 2 i inderfjorden, dog stadig synlig, har mistet ålegræsskud og er overgroet af kraftig epifyt vækst hvilket kendetegner inderfjorden. Der er således, med den nuværende grad af eutrofiering, ikke videnskabelig baggrund for en stor-skala ålegræs restaurering i Odense Fjord. Der er i kystvandrådet arbejdet med virkemidler i oplandet som resulterer i en 40% reduktion af kvælstoftilførslen til fjorden. Denne reduktion kan anvendes i den økologiske model som et reduktionsscenario hvor effekterne af en sådan reduktion kan afsøges. Grundet den korte projektperiode har det ikke været muligt at anvende en modelleret 40 % reduktion scenario, tildægede, har vi detail analyseret en 30 % reduktion scenario afgivet som baggrund i Vandplan 3. Den ny maringenopretning muligheder efter dette 30% reduktion scenario, er beskrevet i dette rapport. Ved at introducere reduktioner af den landbaserede næringssalttilførsel og således nedbringe graden af eutrofiering i fjorden kan det være muligt at få frigjort områder i yderfjorden til anvendelse af marine virkemidler. Denne frigørelse af areal er en forudsætning for yderligere arbejde med marine virkemidler i Odense Fjord. Under denne forudsætning kan SDU pege på enkelte områder i Odense yderfjord hvor der kan afsøges for mulig udførelse af sand-capping i stor skala (Figure 20) samt anlæggelse af sten rev (Figure 21). Til sidst i dette resumé henvises til det sidste afsnit ”Suggestions” for en punktopstilling af anbefalingerne fra SDU omkring anvendelsen af marine virkemidler i Odense Fjord.

Introduction

Eelgrass depth limit is a key element in the Water Framework directive. As such and considering its status (see chapter “background” Figure 9 A), the current eelgrass distribution in most water bodies needs to be improved to reach good ecological status. One of the main underlying causes for the bad ecological condition status of most Danish waters is eutrophication. Besides the last 20 plus years of nutrient reductions, eelgrass populations are not recovering. Hence, together with solutions in the catchment area, eelgrass transplantation together with seaweed cultivation were suggested as a marine mitigation tool in the Danish River Basing Management Plan 3 (DRBMP3). Other marine measures which we will introduce in this chapter are not officially mentioned as mitigation tools withing the RBMP#, however, they add many ecosystem functionalities that the fjords are currently missing, hence contributing to improve the overall ecological status. The focus of this chapter is Odense fjord, hence only marine mitigations tools relevant for Odense fjord will be discussed.

Eelgrass restoration

Eelgrass restoration could in principle be performed using seeds, seedlings, or adult plants. In Denmark, the use of seeds as a restoration method is not yet successful at big scale in the field. In other countries as Netherlands or Sweden, some small field successes with seeds have been performed, but only at small scales (ex. 1m x 1m plots). Seedlings are proven to be much more challenging than adult plants and seeds, hence not a lot of effort is done on using them as restoration material. Transplantation of adult shoots are the most successful large-scale method. The direct transplantation of eelgrass patches is not recommended, because the risk of fragmenting the mature patches is too high. Besides, it cannot be defined as a restoration activity when a patch is moved from one location to another. Although, this research as well as the seeding method is still being developed. The transplantation of apical shoots (last shoots of the vegetative growth of an eelgrass plant) is at present the only method being used in Denmark at large scales. This method has been used to reestablish eelgrass beds at scales of 0.5-5 hectare in Vejle fjord, Horsens fjord, Lunkebugten and Kolding fjord. It has also been tested on small scales and with varying success in Odense Fjord, Roskilde Fjord, Mariager Fjord, Nærá Strand, Lillebælt and Gamborg Fjord. The method for eelgrass transplantation is described in Flindt et al 2023a. In short, the method follows 6 steps:

1. Screening of the area using a site selection GIS tool with available data
2. Visual observation of the area using machine learning tools (ex. drone/orthophotos)
3. Diver observations in sub-selected areas
4. Test transplantation of selected sub-areas and 1 full year of monitoring
5. Large scale transplantation
6. Monitoring of eelgrass development and associated ecosystem functionalities

In Odense fjord we performed steps 1 to 4, and transplanted eelgrass at small scale (test transplantation) in 12 stations divided in the inner and outer fjord during 2022.

Performance of small-scale transplantations in Odense Fjord

During the summer of 2022, small-scale *Z. marina* test transplantations were piloted in Odense Fjord. The purpose of the study was to locate suitable sites for future large-scale transplantations. In May and June 2022, 12 stations were established throughout the fjord for small-scale eelgrass transplantation (Figure 17). Four stations were located in the inner fjord, three stations in the outer eastern fjord, and five stations in the outer western fjord. Along with the developments in *Z. marina*

shoot density in the transplantations, different environmental, physical, and water chemistry were monitored to correlate losses of shoots to certain stressors (Table 3).

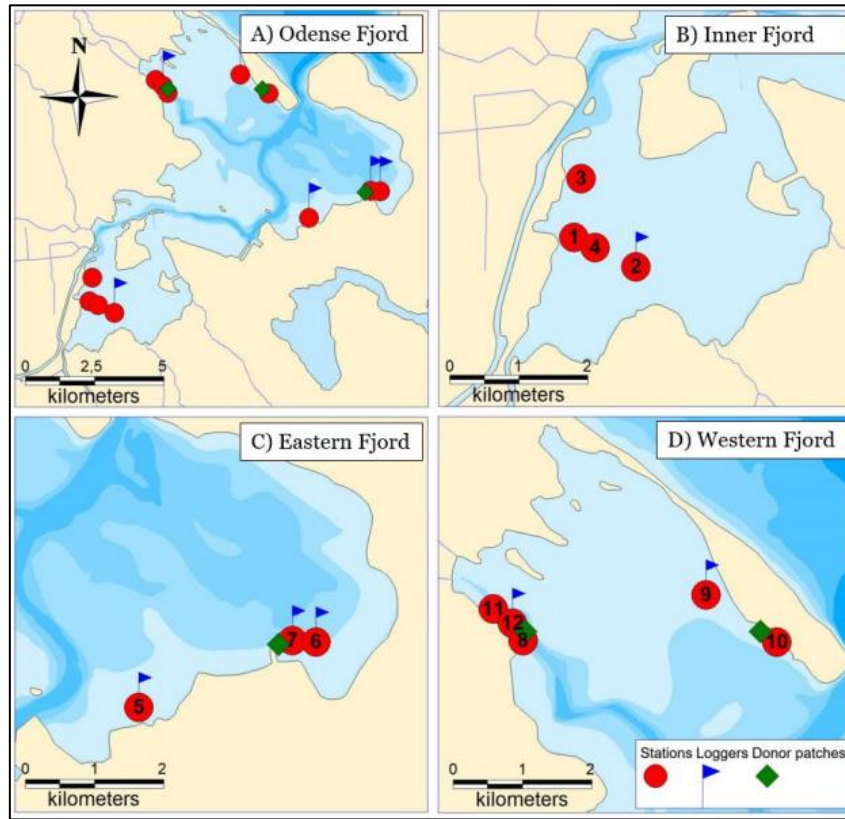

Figure 17. Odense Fjord, Denmark. The entire Odense Fjord with transplantation sites (red circles), logger positions (blue flags), and donor patches (green diamonds) (A), divided into the inner fjord with St. 1-4 (B), the eastern fjord with St. 5-7 (C), and the western fjord with St. 8-12 (D).

By the end of the experiment, only two stations survived through the winter and were considered successful, one in the inner fjord (station 2) and one in the outer eastern fjord (station 7) (Figure 34). The other stations were lost to a combination of multiple stressors (Table 1). In the inner fjord, eutrophication-based stress from fast growing epiphytes and opportunistic macroalgae were the primary stressors. In the outer eastern fjord, the exposure to wave stress was the primary deteriorating force. The same physical stressors, along with ballistic impact from drifting macroalgae, was the underlying cause of eelgrass death for the two stations in the outer western fjord that were located near Enebærodde. The remaining 3 stations in Egensedybet in the outer western fjord were lost due to poor sediment conditions. By the end of the experiment, in March 2023, only Station 7 (west outer fjord) had grown to a higher shoot density than the transplanted (Figure 34, B). Although Stations 2 remained alive, it had lost some shoots and was covered by epiphytes (Figure 34, A). It was therefore concluded that the only suitable location for a large-scale transplantation, based on the small-scale transplantations performed in this study, is north of Bregør in the eastern outer fjord in the shelter of natural *Z. marina* beds (Figure 17).

Table 3. Biotic and abiotic stressors at St. 1 through 12. For the four stressors “Epiphyte growth”, “P. macrophytes”, “Opp. macroalgae”, and “Chl. A”, each X denotes that the station belongs to the significantly highest group of averages for that stressor. For the seven stressors “Worms”, “Crabs”, “Obs. grazing birds”, “Temperature”, “DIN”, “Exposure”, and “LOI”, an X denotes that conditions at that particular station exceed the lower (and in some cases only), literature-based threshold for *Z. marina* recolonization, while two XX's denote that both the lower and upper thresholds have been

exceeded. For the three stressors “Hypoxia”, “Salinity”, and “Light”, an X denotes measured levels of each parameter below the upper (and in some cases only) minimum threshold for *Z. marina* recolonization, while two X’s denote measured levels below both the upper and the lower, literature-based thresholds.

	Epiphyte growth (p<0.1)	P. macrophytes (p<0.1)	Opp. macroalgae (p<0.1)	Chl. A (p<0.1)	Worms (>5-10 n m ⁻²)	Crabs (>4 n m ⁻²)	Obs. grazing birds	Temperature (>25 °C)	Hypoxia (<2-4 mg l ⁻¹)	DIN (>34 µg l ⁻¹)	Salinity (<5 ppt)	Light (<200-300 µE m ⁻² s ⁻¹)	Exposure (>0.5-0.7 N m ⁻²)	LOI (>2-5%)
1	X	X	-	-	-	-	X	X	X	X	X	-	-	-
2	X	X	-	-	-	-	X	X	X	X	X	-	-	-
3	X	X	-	X	-	-	X	X	X	X	X	-	XX	X
4	X	X	X	-	-	-	X	X	X	X	X	-	-	-
5	X	-	-	-	X	-	-	-	XX	X	-	-	X	-
6	-	-	-	-	-	-	-	-	XX	X	-	-	X	-
7	-	-	-	-	-	-	-	-	XX	X	-	-	-	X
8	X	-	-	-	-	-	-	X	XX	X	-	-	-	XX
9	-	X	-	-	-	-	-	X	XX	X	-	-	XX	-
10	-	-	-	-	-	-	-	X	XX	X	-	-	XX	-
11	-	X	-	-	-	-	-	X	XX	X	-	-	-	XX
12	X	-	-	-	-	-	-	X	XX	X	-	-	-	XX

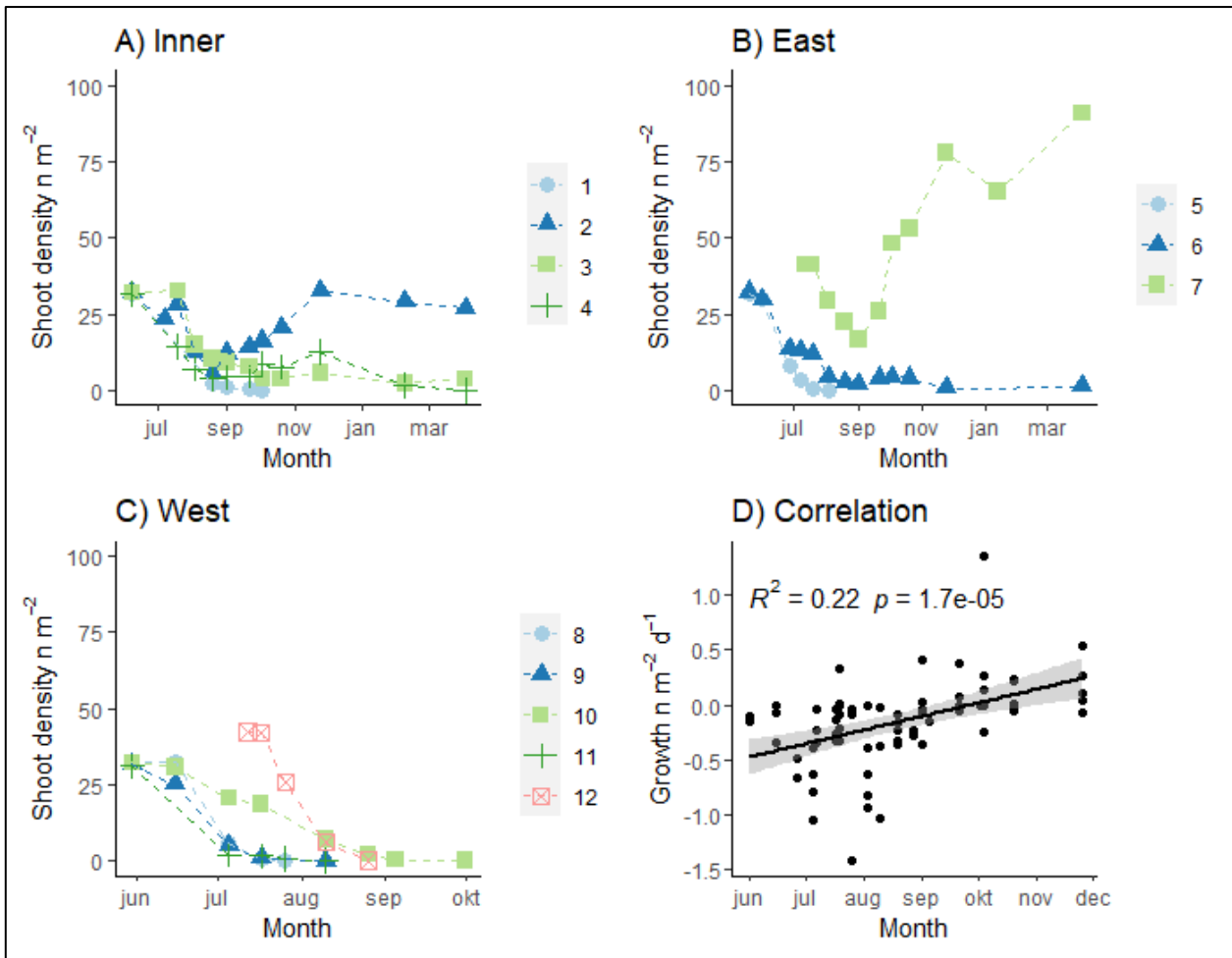

Figure 34. Odense Fjord, Denmark. Shoot density ($n\ m^{-2}$) as an average of the 5 transplanted rings of stations 1-4, 5-7, and 8-12 over time (A-C). Correlation between growth and the day of the year for the entire fjord, the shaded area represents 95% confidence interval of regression (D).

Based on the measured/modelled environmental conditions explained in detail in chapter “background” and this test transplantation pilot in Odense, it is our conclusion, that the current levels of eutrophication in the inner fjord are too high to start large-scale eelgrass transplantation activities. The concentration of DIN induced high biomasses of opportunistic species and epiphytes. So even though the inner part of Odense fjord is sheltered and shallow (supports high benthic light intensities), the environmental conditions are not suitable for eelgrass restoration. In the outer fjord at the current environmental conditions, the high concentrations of DIN are reducing the potential restoration areas, except for some small areas in the Northeast and Northwest areas. In these two areas some efforts to improve the physical conditions could improve the eelgrass survival. However, as stated, the current available areas are small. Therefore, to attempt large-scale transplantation, some extra mitigations need to be implemented.

Reduction from the catchment area

The concentration levels of DIN are too high for most of the fjord area, hence a nutrient reduction will be needed. In Chapter xx, it is described a reduction scenario in the catchment that could reduce up to 40% of the current nitrogen load to the fjord.

We have estimated the effect of 30% nitrogen reduction of runoff from the catchment area on the fjord concentrations, using the RBMP3 model for Odense fjord (Figure 35). A nitrogen reduction of 30% will improve the environment condition in the outer part of Odense fjord (green areas in Figure 35). Improved DIN will reduce epiphytic coverage and growth of opportunistic species and increase the benthic light availability reaching eelgrass. Besides, it will slow down the nutrient turnover, which will improve the oxygen conditions of the area. If we focus on the Northwest of the fjord, where the main stressors affecting eelgrass survival were pointed out to be DIN and hypoxia (Table 3), the potential eelgrass survival should improve directly by this reduction. If we focus on the northeast part of the outer fjord, other underlying stressors (exposure, benthic light, sediment conditions and drift of perennial macrophytes), were impairing the eelgrass growth together with the high DIN concentrations and frequent development of hypoxia (Table 3). For these areas extra mitigation tools, together with the nutrient reductions are needed to improve the eelgrass survival. In the inner fjord the levels of eutrophication remain too high even after a 30% reduction. For these areas eelgrass restoration is not recommended, even with extra supporting mitigation tools. However, mussel banks, if the conditions are favorable, could be suggested in a test scale to evaluate their potential effect on the area.

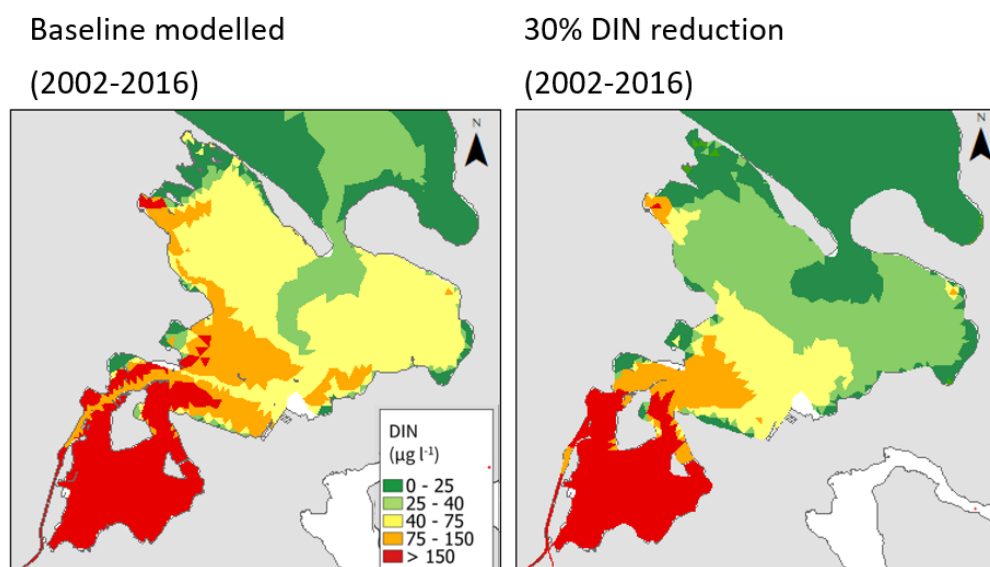

Figure 35. Growth season average DIN based on Odense fjord RBMP3 model at baseline conditions and after a 30% reduction on nitrogen from the catchment area (2002-2016).

Sand capping

After nutrient reduction, the southeast of the outer fjord (Figure 20, black square, Otterup area), could be highlighted as potential area for eelgrass transplantation in combination with supportive mitigation tools that improve the sediment conditions. That area is characterized by highly organic muddy sediments with a high content of silt and clay (high LOI) (Figure 20). This type of sediment reduces the anchoring capacity of eelgrass and reduces the light availability to the seabed by frequent resuspension (see also Chapter “background”). Sand-capping can assist the transplantation potential

of this area. This technique consists of capping muddy sediments with 10cm of sand. Flindt et al (2022) demonstrated the efficiency of this technique that increases the resistance of sediments to resuspend from 10-12cm s⁻¹ in mud to ~40cm s⁻¹ in sand. However, to optimize the sand-capping effect large areas must be implemented. If the sand-capped areas are small it is surrounded by neighboring muddy areas, the risk of reintroducing the fine muddy particles into the sand cap is too big. Local hydrodynamics should also be considered when screening for optimal areas for sand-capping. Therefore, in order to suggest suitable areas within Egensedybet a detailed study is needed.

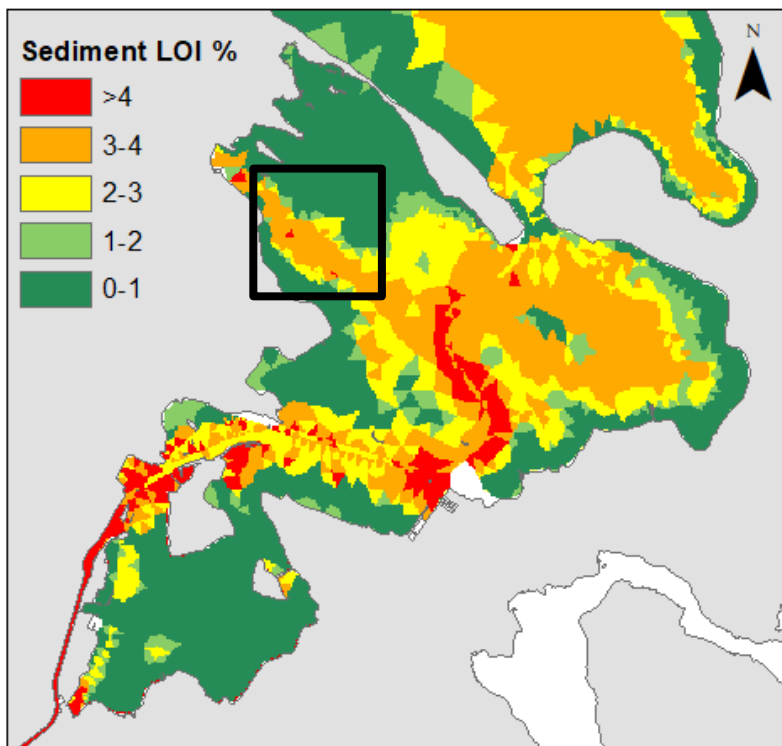

Figure 20. Odense fjord, Denmark. Sediment organic content (LOI) from the RBMP3 model.

Stone reefs

After nutrient reduction, the northwest of Odense outer fjord (Figure 21, black square, Enebærodde), could be highlighted as potential area for eelgrass transplantation in combination with supportive mitigation tools that can provide shelter against wave and current action as well as against the ballistic impacts of drifting macroalgae.

Stone reefs would be placed as mitigation measure to assist eelgrass transplantations. However, given the right environmental conditions, stone reefs would create added value to the ecosystem functionalities of the area. Functional stone reefs, act as shelter for eelgrass and improve the species density and fauna diversity. They further are substrate for many perennial algae species, which could benefit from this stable substrate in this area. In Odense fjord, only small stones, gravel, and shells act as hard substrate for perennial macroalgae species in the outer fjord. The synergistical effects of coupled stone reefs and eelgrass beds are being investigated in the project Sund Vejle fjord.

The disposition of stone reefs can vary. There are three overall stone reef types: barrier reefs, boulder reefs (cave forming) and diffuse reefs. Barrier reefs and cave forming reefs would offer the highest protection against physical stress. Diffuse reefs may even increase the macroalgae drift problem in the area, hence they are not recommended.

The exact positioning of a reef in the area should be thoroughly examined. For instance, stone reefs should not be placed in muddy areas without ability to carry the stones. According to our data, the area around Enebærødde is defined by sandy sediments and will be able to carry the weight of the stones. However, a local test is necessary to confirm this statement. After placing a stone reef, the local hydrodynamic would change, creating new areas of erosion and sedimentation. Therefore, the reefs had to be placed in advance to allow the area to reach a new steady state before any eelgrass transplantation is recommended. To achieve an optimal positioning for a stone reef in the area which both increase sheltering for new eelgrass beds and home stable benthic vegetation, a thorough pre-study is needed. The reef needs to be adapted/designed to ex. the local hydrodynamics, the sediment characteristics, and the light availability. Specific guidelines and further information on the restoration of stone reefs can be found in Dahl et al (in prep.) and Stæhr et al (in prep.)

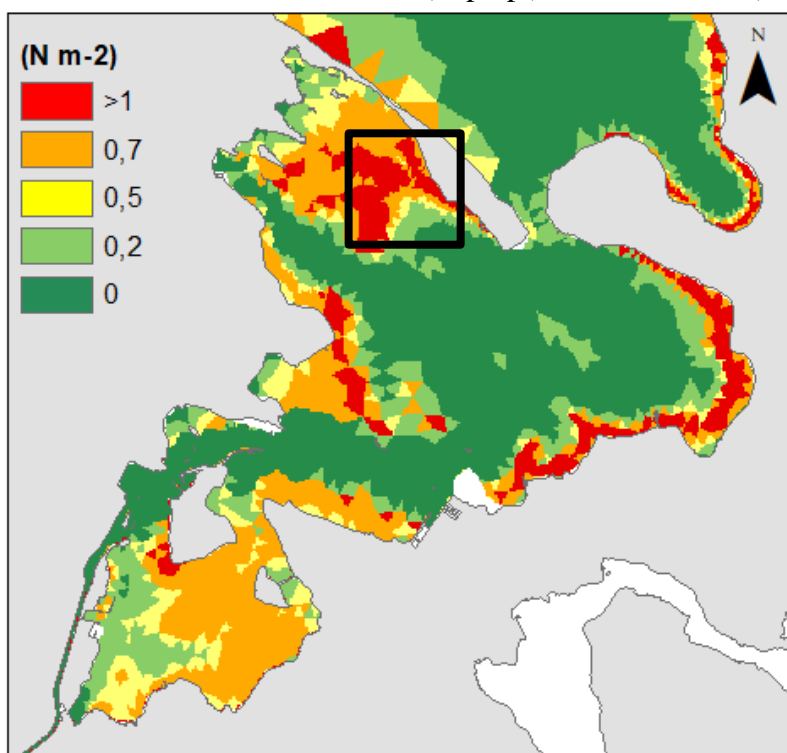

Figure 21. Odense fjord, Denmark. Critical share stress (physical exposure) from the RBMP3 model.

Biogenic reefs

Biogenic reefs alone or in combination with eelgrass beds are being tested in Vejle fjord. The aim of placing biogenic reefs is to increase the local light availability at the seabed. Mussels are effective filter feeding organisms, which filter the water column for plankton, hence reducing the turbidity in the water. In the project Sund Vejle fjord, it has been registered a local effect of 15-30 % light improvement in areas with newly established biogenic reefs. Large biogenic reefs could also provide (to a lesser extent than stone reefs) a sheltering effect for eelgrass. However, the synergistic effect of biogenic reefs and eelgrass are not yet fully quantified. The partial results point towards positive interaction due to the increase local water quality, increase habitat complexity which positively affect the overall biodiversity. There are several types of biogenic reefs, two of the most common ones in Denmark are oyster reefs and blue/horse mussel reefs (Nielsen et al 2023). In Odense fjord, there

have been blue mussel fisheries, however they have been closed for many years. But this indicates that blue mussels (*Mytilus edulis*) have been inhabiting the water of Odense fjord. Oyster shells (*Ostrea edulis*) can be found in diked areas around the fjord (ex. Egensedybet), which indicates the earlier existence of oysters in the fjord. However, to our knowledge, there are no large beds of mussels or oysters in the fjord. Biogenic reefs are useful mitigation tools in highly eutrophic areas, hence the center of the fjord or the inner fjord could be areas where biogenic reefs could be tested (Figure xx DIN). However, other parameters must be right for the reef to survive. For instance, blue mussel reefs require salinities of 10-38 PSU, depths of >3m, organic content of the sediment of >10 % LOI and oxygen conditions of >4mg O₂ l⁻¹ (Nielsen et al 2023). The inner part of Odense fjord is the area that would most benefit from biogenic reefs, but this area is shallow. It is also muddy, with too organic sediments. The outer part of the fjord is deeper and has larger areas with sandy sediments. At present conditions (with the eutrophication signal reaching to the outer fjord) biogenic reefs might also be useful in the outer fjord. However, after the desired reduction of 30%, their presence will continue enhancing the complexity and biodiversity of the fjords habitats but might not have the strongest effect on palliating eutrophication.

A more detailed description of the ecosystem services and known synergies of these habitats can be found at Flindt et al 2023b.

A more detailed description of the practical considerations and management considerations can be found in the respective guidelines provided by the center of Nature restoration (Flindt et al 2023, Stær et al 2023 and Nielsen et al 2023).

Economic considerations

The exact estimate of the cost for marine restoration oscillates widely from project to project. To give a realistic price some consideration:

- How large is the area that needs to be restored with a certain tool. The higher the area in general terms the lower cost per area, since some of the initial investment is used at the beginning of the project, regardless the area implemented (ex. permitting, baseline surveying, mobilization costs etc.).
- There is a national consensus on the need of monitoring new established habitat until they reach a natural steady state. However, at present there are no official guidelines on how and what to monitor after the project is complete. The Danish Center for Nature restoration is currently working on the development of guidelines to monitored restored marine habitat (which will include all of the habitats named in the present report). The prices for monitoring the restored habitat is hence likely to change after the official guidelines.
- How much citizen science involvement would the project aim for. Some restoration techniques such as eelgrass transplantation have been successfully implemented by using science (to a large extent citizen). This reduces the costs significantly.
- The use of technical divers vs. snorkelers will also increase the time of the operative phase and costs.
- Other factors such as transportation costs depending on location, changes on raw material prices etc. should be as well considered as an uncertainty.
- The placing of some mitigation tools such as stone reefs or sand-capping, requires sometimes an archeological survey, which is done by the historical museum. The prices of these surveys depend on the conditions of the specific area and oscillate on a wide range.

- The commercial prices for the different activities oscillate withing companies and projects, they are also greatly affected by the offer and demand. Hence, we will not estimate prices based on commercial salaries for all field work.
- The below mentioned budget does not include material cost (ex. vessels, divs. materials, diving equipment, rental of laboratory facilities etc.) unless otherwise specified.

Eelgrass

Following the method described in Flindt et al 2023, we estimate it would take about 63 full working days to screen for 12 locations within Odense fjord. This time accounts for prescreening and licensing (steps 1-4). Given the low rates at the University and the need to include maximum 1 model scenario run (from Odense's pre-existing model), prescreening price would round the 260 Kkr. The costs of big scale transplantation with apical shoots (step 5) as described above is estimated on ~375 Kkr/ha. In Sund Vejle fjord, the project organized 5 citizen science field campaigns, which reduced the labor prices. Hence in Sund Vejle fjord, 6 ha of eelgrass beds were transplanted withing 5 years with estimated budget of 1.5 mio kr (instead of our estimate which will add up to 2.25 mio kr.). This calculation does not consider market prices from private business, which given the rates and working conditions will increase the budget and time significantly.

Monitoring activities which should follow the established eelgrass over the consequent years are estimated to prices varying between ~20-70 Kkr year⁻¹ ha⁻¹.

Sand-capping

From previous experiences in Odense fjord, Sand-capping costs are ~250 Kkr ha⁻¹. This price included the raw materials and all operational costs by a professional company.

Site selection and monitoring over the consequent years are estimated on a price of ~20-70 Kkr year⁻¹ ha⁻¹.

Stone reefs

As with all other tools the site selection and permitting for a specific location is dependent on the extension of the area and the number of areas withing the water body. In the project Sund Vejle fjord we estimate a cost of about 0,3-0,5 mio. kr for preliminary surveying and permitting.

The specific design of a stone reef will define the volume of stones per area needed, which have a large effect on the overall budget. The origin of the raw materials will also affect greatly the prize. In our projects we have worked with two different setups. Stone banks, where reefs are built from stones collected at cultivated fields, which were delivered to a specific location by the landowners. And granite boulders imported from Norway. In Sund Vejle fjord 8 ha of stone reefs were established for a total price of 5 mio. kr. This 8 ha were spread in 5 reefs, and each reef followed a different design, ranging from barrier reef, boulder reef and spread reef. In total, 8350 m³ stones were used. The 5 mio kr. included the cost of the material, as well as its transportation and placement in the five areas.

Monitoring activities which should follow the established stone reefs over the consequent years are estimated on a price of ~20-70 Kkr year⁻¹ ha⁻¹.

Bioreefs (mussel banks)

The re-establishment of mussel banks in an area requires the establishment of a mussel farm to harvest local mussel seed and grow up to 2-3 cm size increasing the survival rates when relay.

There are different kinds of mussel farms at use in Denmark. Mussel line production and SmartFarm production. The cost of establishing both kinds of farms is different. Smart farms are expensive to establish and need to be operated by a certain type of vessel. However, the production rate per area is bigger, making the operative expenses cheaper in the longer term. Not all farms can be situated in all areas, they are dependent on the available depth and other physical factors as well as the economic considerations. More information regarding the different prices and types of farms can be found at Bruhn et al 2020 & Petersen et al 2021.

As an example, in the project Sund Vejle fjord, it was established a line mussel farm of 17 ha for a total cost of about 1.5 mio kr. The estimated production cost was about 1 mio kr year⁻¹. The biomass produced per year was relayed in beds of varying density (2-6 kg/m²). The total area established oscillated between 6-12 ha year⁻¹. In all, with a total investment of 5 mio kr, 39 ha of mussel beds were established in Vejle fjord between the years 2020 and 2023. This price includes all operational costs, transport and materials. However, it does not include the site selection for the establishment of the mussel farm, nor the site selection of sites to re-establish the mussel beds, which is estimated in about 0,3-0,5 mio kr.

Monitoring activities which should follow the established biogen reef over the consequent years are estimated on a price of ~20-70 Kkr year⁻¹ ha⁻¹.

Suggestions:

Based on the environmental analyses of Odense Fjord, we suggest the below flow of mitigation activities for improvements of the estuary. This is also aligned with our currently granted project by AVJ (about 7 mio. kr.)

1. Improve the sediment and light climate by large-scale sand capping activities around Firtalsdæmningen and along the Southern shoreline of Egensedybet. If more sand is available some of the bays around Klintebjerg would also be prompt for a possibility.
2. Areas for Stone reefs must be qualified by sand transport modelling. Here we suggest focusing on locations: Enebærodde, Firtalsdæmningen and Bregør.
3. To initiate restorations of bioreefs (mussel banks), finding an optimal area for mussel production and optimal sites for placing future mussel banks would be needed. Here we must qualify high growth rates of mussels and no development of anoxia. It is possible to perform combined model and field-activities to find these locations, where measurements of mussel growth/losses are performed on small scale test-banks.
4. Eelgrass restoration has a very limited potential in Odense Fjord, as only one large-scale site showed potential (Bregør). As the nitrogen reduction gets realized more test-transplantation will be performed, and hopefully more large-scale restoration sites will be available.
5. Coastal realignment also has the potential to create more productive shallow areas in Odense Fjord. Here it is obvious to focus on Lumby Inddæmningen, where we also in a climate perspective have possibilities to regain some of the lost coastal meadows.

References

- Bruhn A, Flindt MR, Hasler B, Krause-Jensen D, Larsen MM, Maar M, Petersen JK og Timmermann K. 2020. Marine virkemidler – beskrivelse af virkemidlernes effekter og status for vidensgrundlag. Aarhus Universitet, DCE – Nationalt Center for Miljø og Energi, 126. - Videnskabelig rapport nr. 368 <http://dce2.au.dk/pub/SR368.pdf>
- Dahl, K., et al (In prep). Vejledning (Best practice) til naturgenopretning af stenrev. Videnskabelig rapport fra Nationalt Center for Marin Naturgenopretning – 2023
- Flindt, M., Steinfurth, R., Banke, T. L., Lees, M. K., Svane, N., Canal-Vergés, P., Bramming, T., Timmermann, K., & Stær, P. A. U. (2023 a). Ålegræs - Guideline til udpegning af optimale storskala udplantningsområder. I Ålegræs - Guideline til udpegning af optimale storskala udplantningsområder. Videnskabelig rapport fra Nationalt Center for Marin Naturgenopretning.
- Flindt M, Jørgensen TB, Petersen JK, Stær PAU. (2023 b). Marine habitaters understøttelse af vigtige biologiske økosystemtjenester. Videnskabelig rapport fra Nationalt Center for Marin Naturgenopretning. <https://marinnatur.dk/media/72366/marine-habitatersoekosystemtjenester.pdf>
- Flindt, M. R., Oncken, N. S., Kuusemäe, K., Lange, T., Aaskoven, N., Winter, S., Sousa, A. I., Rasmussen, E. K., Canal-Vergés, P., Connolly, R. M., & Kristensen, E. (2022). Sand-capping stabilizes muddy sediment and improves benthic light conditions in eutrophic estuaries: Laboratory verification and the potential for recovery of eelgrass (*Zostera marina*). *Journal of Sea Research*, 181, Article 102177. <https://doi.org/10.1016/j.seares.2022.102177>
- Nielsen, P., Taylor, D., Banke, T. L., Saurel, C., Holbach, A. M., & Petersen, J. K. (2023). Vejledning for udpegning af områder egnet til etablering af blåmuslingebanker. Videnskabelig rapport fra Center for Marin Naturgenopretning.
- Petersen, J.K. (red.), Timmermann, K. (red.), Bruhn, A., Rasmussen, M.B., Boderskov, T., Schou, H.J., Erichsen, A.C., Thomsen, M., Holbach, A., Tjørnløv, R.S., Lange, T., Canal-Vergés, P. & Flindt, M.R. (2021). Marine virkemidler: Potentialer og barrierer. DTU Aqua-rapport nr. 385-2021. Institut for Akvatiske Ressourcer, Danmarks Tekniske Universitet. 49 pp. + bilag
- Stær, P., (In prep). Forhold af betydning for naturgenopretning af stenrev. Videnskabelig rapport fra Nationalt Center for Marin Naturgenopretning – 2023

Oplandsbeskrivelse og stoftransport ift. Odense Fjord (AP 2.1 og AP 2.2)

Characterization of Odense Fjord catchment. Technical note.

Authors: Flemming Gertz SEGES Innovation, Karsten Dollerup Møller SEGES Innovation

Cite: Gertz F & Møller K D, 2023. Characterization of Odense Fjord catchment. Technical note from SEGES Innovation.

Resumé

Odense Fjord opland er et 105.000 ha stort fortrinsvist drænet opland bestående af 60 % lerede jorde, 11 % humusjord og 29% sandede jorde. Landbrug udgør 64% af arealet, mens natur og by/infrastruktur udgør hhv. 15 og 12 %. Transporter af næringsstoffer i oplandet viser, at tab fra landbruget udgør størstedelen, men spildevand udgør en betydelig del i sommerhalvåret, hvor afstrømningen fra land er mindre. Tilførslen af både kvælstof og fosfor er faldet gennem årene. Fosfor er primært faldet i 1980'erne, som følge af bedre spildevandsrensning, mens kvælstof primært er faldet gennem 1990'erne. Vinterens kvælstofafstrømning er ikke faldet siden ca. 2010, mens sommerens nitratkoncentrationer opstrøms Odense by i de 4 største vandløb stadig falder, og i dag er under 1 mg/l nitrat-N i de 3 sommermåneder. Både nye og gamle data indikerer, at næringsstoftransporten, både hvad angår fosfor og kvælstof, kan være underestimeret på grund af, at der med monitoringsprogrammet ikke udtages prøver med tilstrækkelig høj frekvens.

Geology and land use

Odense Fjord has a catchment area of 105,000 hectares, covering approximately one-third of Funen. The last ice age characterizes the entire catchment area – Weichsel ice age - and the landscape is shaped by the ice, mainly clay deposits with elements of sand deposits. The soil consists of 60% clay soils, 11% humus, and more sandy soils (Figure 1 & Tabel 1). The landscape around the fjord is low-lying and several areas around the fjord have been claimed for land use over time. Soil map with soil types indicating marine sediments sand/clay in areas close to the fjord (Figure 1, left bottom).

Drainage

Drainage is important for transporting nutrients to the aquatic environment. Aarhus University has calculated the drainage probability for the whole of Denmark, and Figure 1 shows a section of the drainage probability map for Odense Fjord's catchment area. The majority of the catchment has a high probability of drainage due to the predominantly clay soils. The nutrient concentrations in streams are typical for drained soils with higher winter concentrations than typically seen in sandy soils but low concentrations in summer due to less influence from drainage water and higher influence from groundwater (Figure 5).

Agriculture

Agricultural land use makes up around 64% of the total area, corresponding to around 63800 ha (Tabel 2).

The number of livestock productions, cattle, pigs, and poultry is distributed roughly equally in the catchment if cities and nature are disregarded (livestock Figure 2). The intensity of livestock

production is also distributed roughly equally in the landscape outside cities and nature. Manure production “hotspots” are seen (Heat map Figure 2) but due to regulation for manure the heatmap does not reflect the total use of fertilizer including manure on the fields.

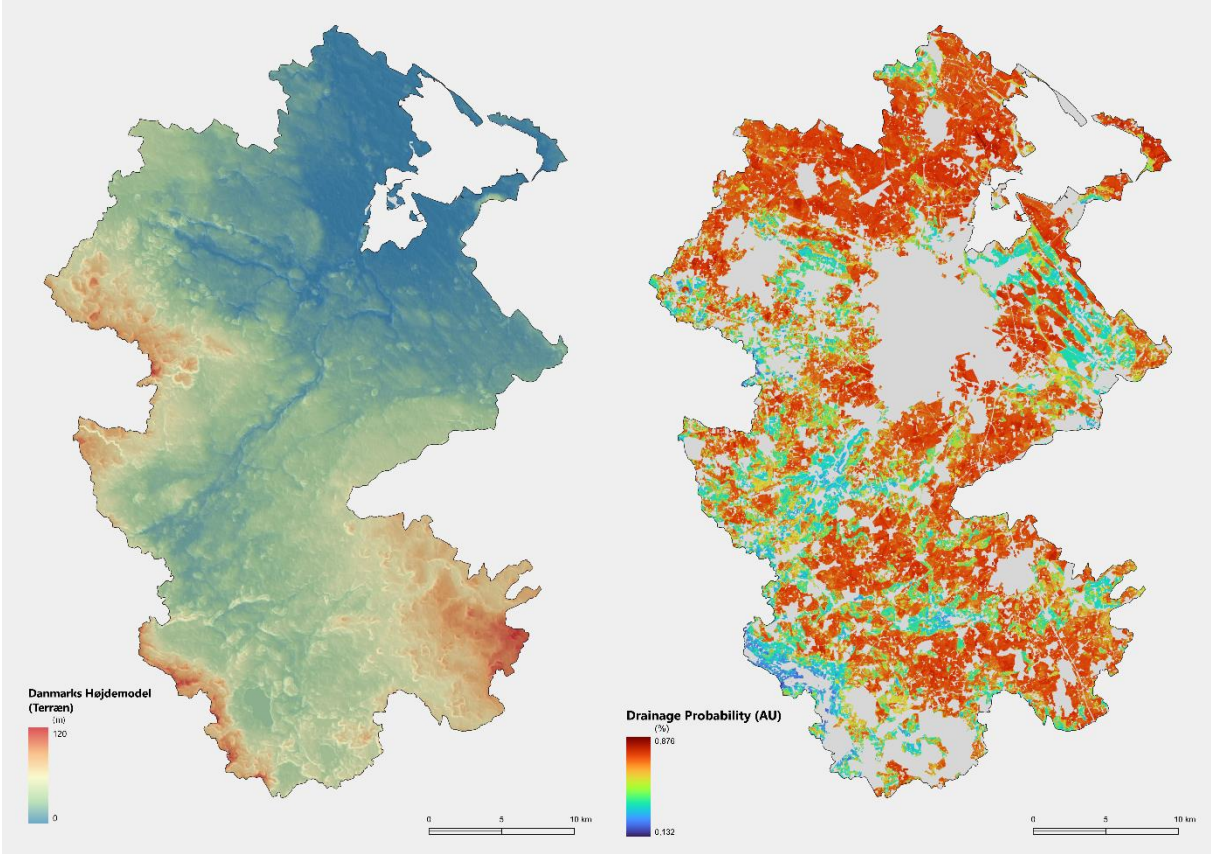

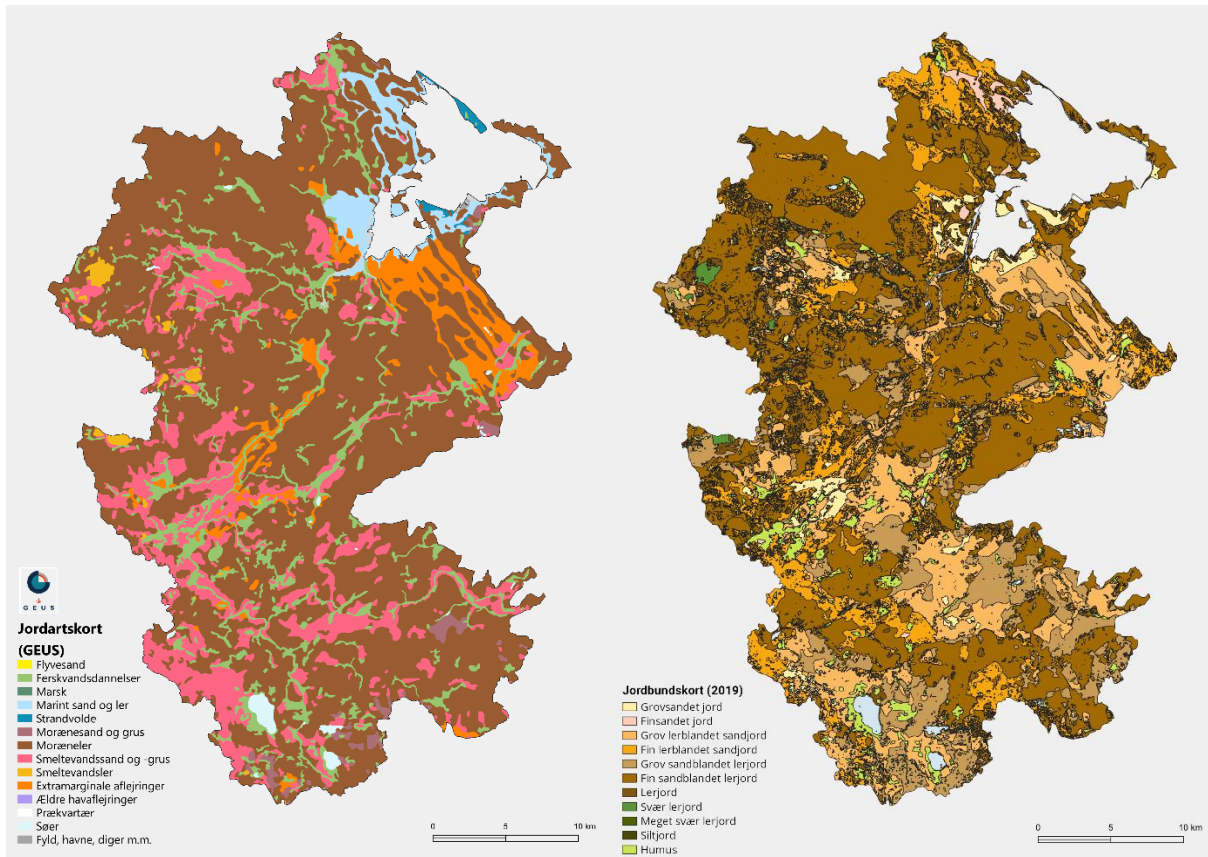

Figure 1. Upper L: Terrain model (Geodatastyrelsen). Upper R: Calculated potential drainage (Aarhus University). Bottom L: Soil type map 1 (GEUS). Bottom R: Soil type map 2 (Aarhus University).

Table 1. Area distribution of soil types in the catchment area of Odense Fjord

Soil type	JB nr	Area (ha)	(%)
Fin sandblandet lerjord	6	48405	46
Fin lerblandet sandjord	4	17310	16
Grov lerblandet sandjord	3	16447	16
Grov sandblandet lerjord	5	14166	13
Humus	11	4337	4
Grovsandet jord	1	2488	2
Lerjord	7	975	1
Finsandet jord	2	551	1
Svær lerjord	9	285	0,3
Total		104963	100

Table 2. Land use

Type	Area (ha)	(%)
Agriculture	63791	64
Infrastructure	11512	12

Nature	14891	15
Rivers, lakes and wetlands	6347	6
Unknown	3198	3
Total	99739	100

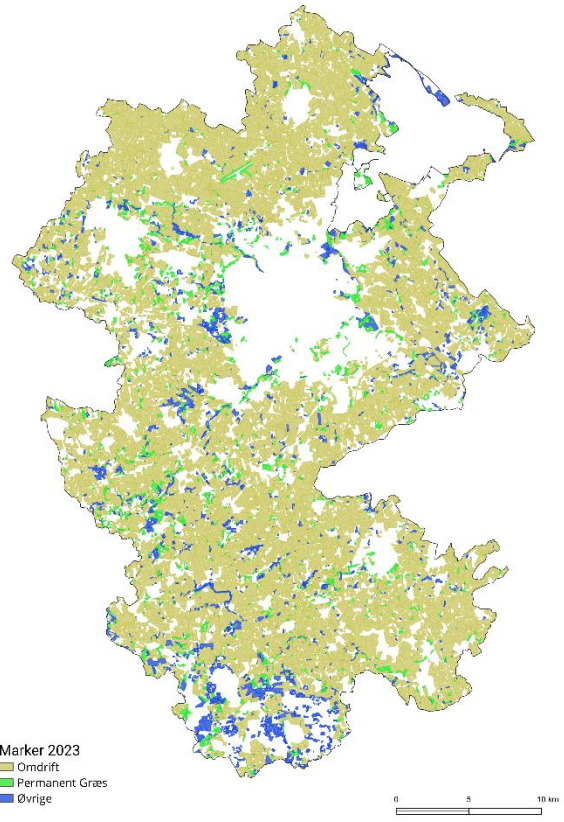
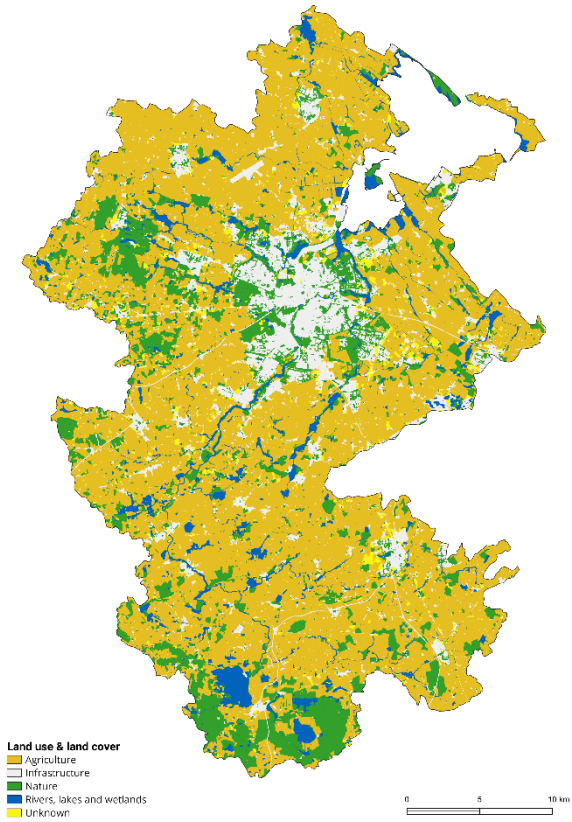

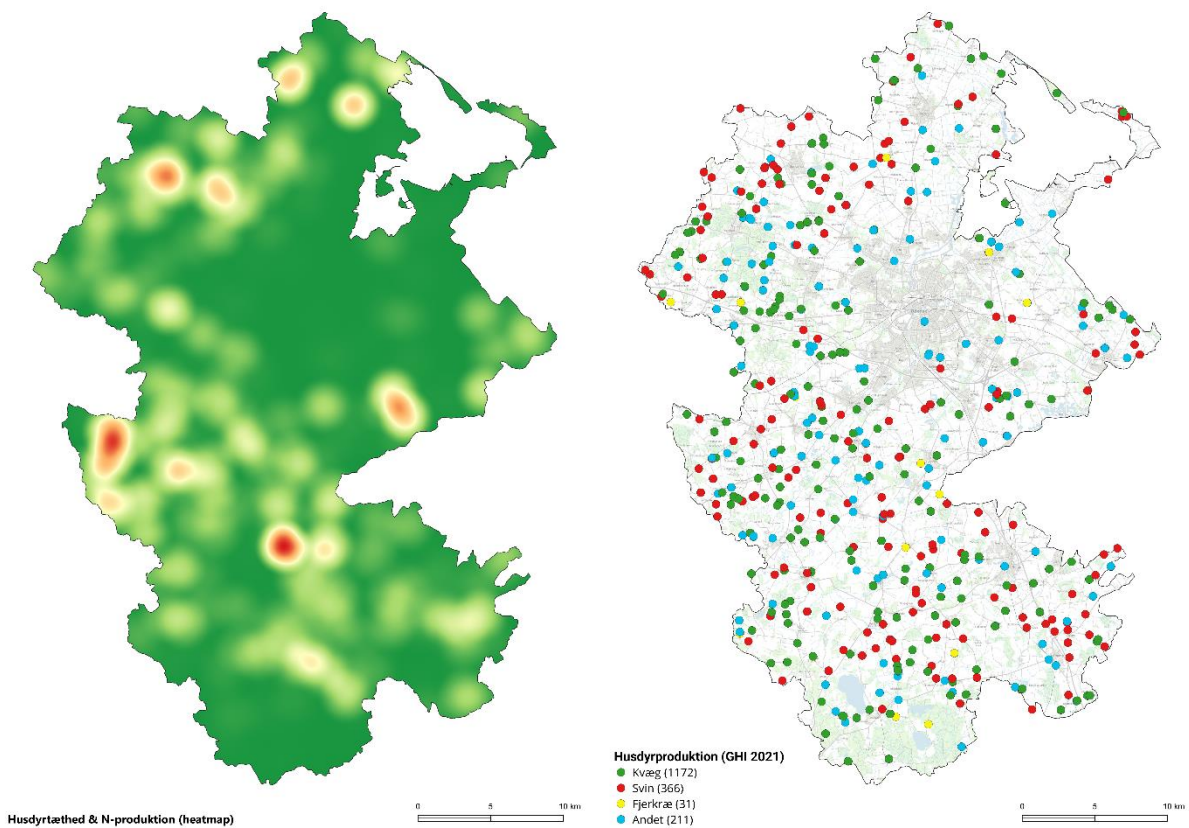

Figure 2. Upper L: Land use. Upper R: Agriculture divided into cultivated area and permanent grass. Bottom L: The area-distributed livestock production of nitrogen (Heat map). Bottom R: Area distribution of agriculture with livestock production.

Sewage

In the catchment area of Odense Fjord, there are according to the national database for wastewater (PULS), 14 treatment plants, 200 sewage overflows and 570 rainwater overflows (Figure 3). Discharges from treatment plants make up most wastewater discharges, with 56% for phosphorus and 75% for nitrogen (Figure 3).

Emissions from properties that are not connected to the wastewater system are not included in the calculation as point sources but as diffuse sources, because they are not included in the PULS database. It is generally estimated that these properties make up a small part of the total wastewater discharge from the catchment area.

The biggest uncertainty is overflow incidents, as these have not always been reported with sufficient care by the municipalities to the national database. However, this has been improved over recent years and reported data after 2021 is significantly better than in previous years. But still, there is some uncertainty concerning how much and how often overflows occur.

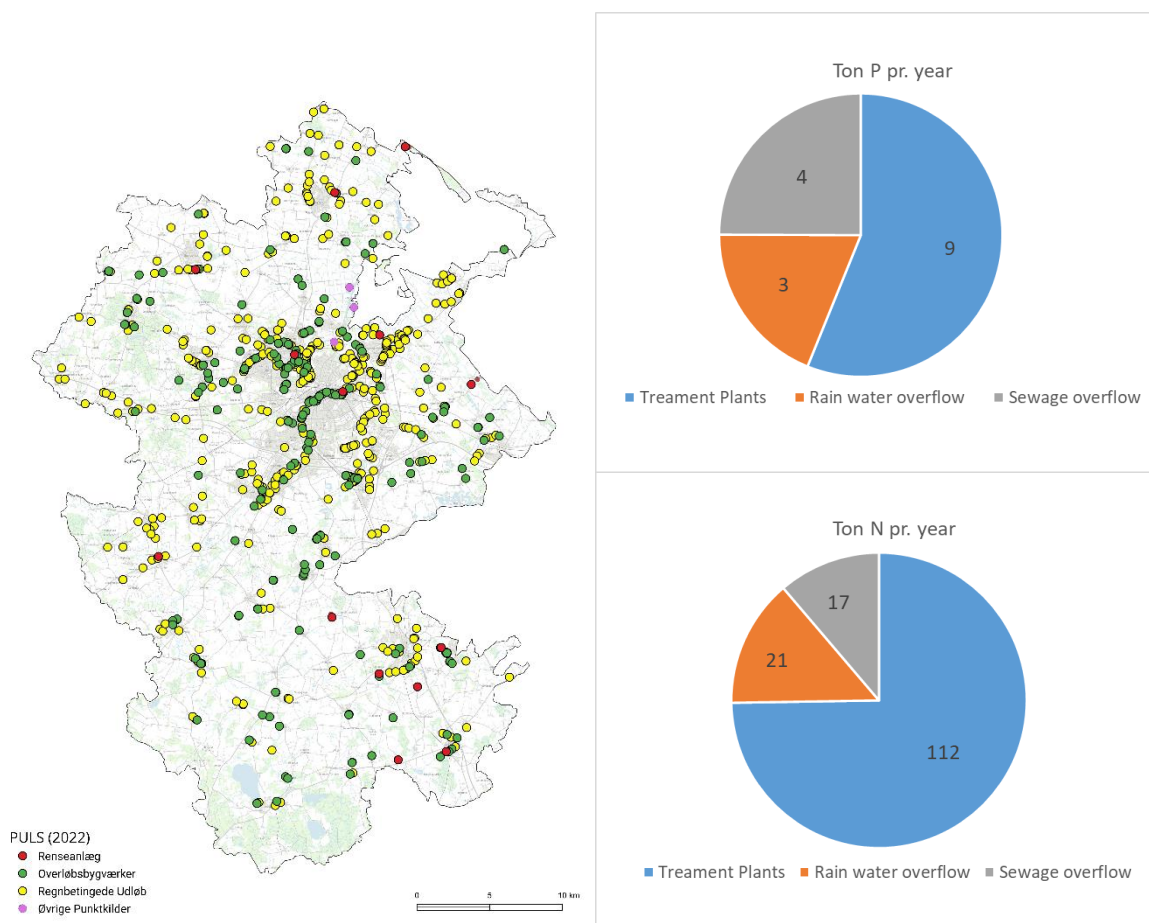

Figure 3. Location of treatment plants (red), overflow from wastewater (green) and rain water outlets (yellow), as well as distribution between the 3 types of waste water for nitrogen and phosphorus. Data 2021 from the PULS database.

Transport of nutrients and concentration of nutrients in streams

The calculations of nutrient transport in the catchment to Odense fjord are based on Aarhus University's calculations and include both measured and unmeasured catchment. The measured catchments are sub-catchments where both water transport and nutrient concentrations have been measured (**Fejl! Henvisningskilde ikke fundet.**).

The unmeasured catchments are the parts of the catchment with no monitoring for flow and nutrient concentration. Calculations have been made for these catchments to estimate the total loss of nitrogen and phosphorus. In all sub-catchments, there are wastewater discharges, but the largest discharges from Odense City are not included in the monitoring of the streams because the monitoring stations are located upstream of Odense City and the major treatment plants but wastewater discharges are included in the total transport calculations (Figure 10 to Figure 13).

The nitrate concentrations have decreased in all 4 streams in the last 30 years (Figure 5). Especially the winter concentrations have decreased from levels of 6-10 mg/l to 3-5 mg/l but in the last 10 years, the winter concentrations have not decreased further. The summer concentrations on the other hand seem to continue to decrease and are the last few years below 1 mg/l as an average in the 3 summer months (Figure 6). Summer nitrate concentrations have decreased by 20-30 % from 2016-2018 to 2022-2023.

Phosphorus concentrations decreased in the early part of the monitoring period mostly in the late 1970s (Figure 7) mainly due to increased wastewater treatment. Concentrations today are on average 0,1 mg/l but these numbers properly underestimate the real concentrations. This is illustrated by the monitoring in Odense Å when the monitoring program was dramatically increased. In the summer of 1989, the sampling frequency went from 2-3 samples pr. month to one sample every day. The data (Figure 8) demonstrates that low-frequency sampling does not register peaks in concentrations well. Peaks in concentrations are typically associated with peaks in flow and therefore peaks in the total transport of phosphorous could be well underestimated.

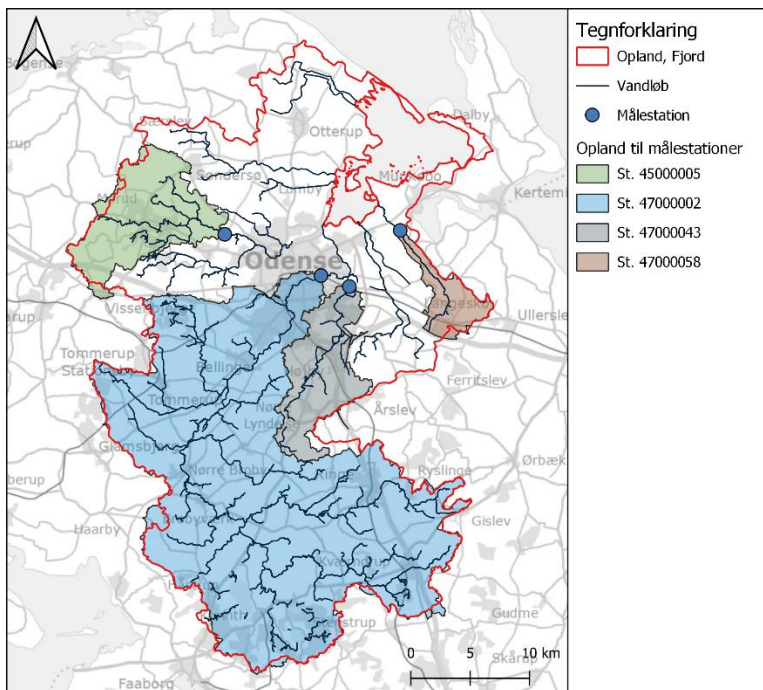

Figure 4. Map with monitoring stations for nutrients and water flow

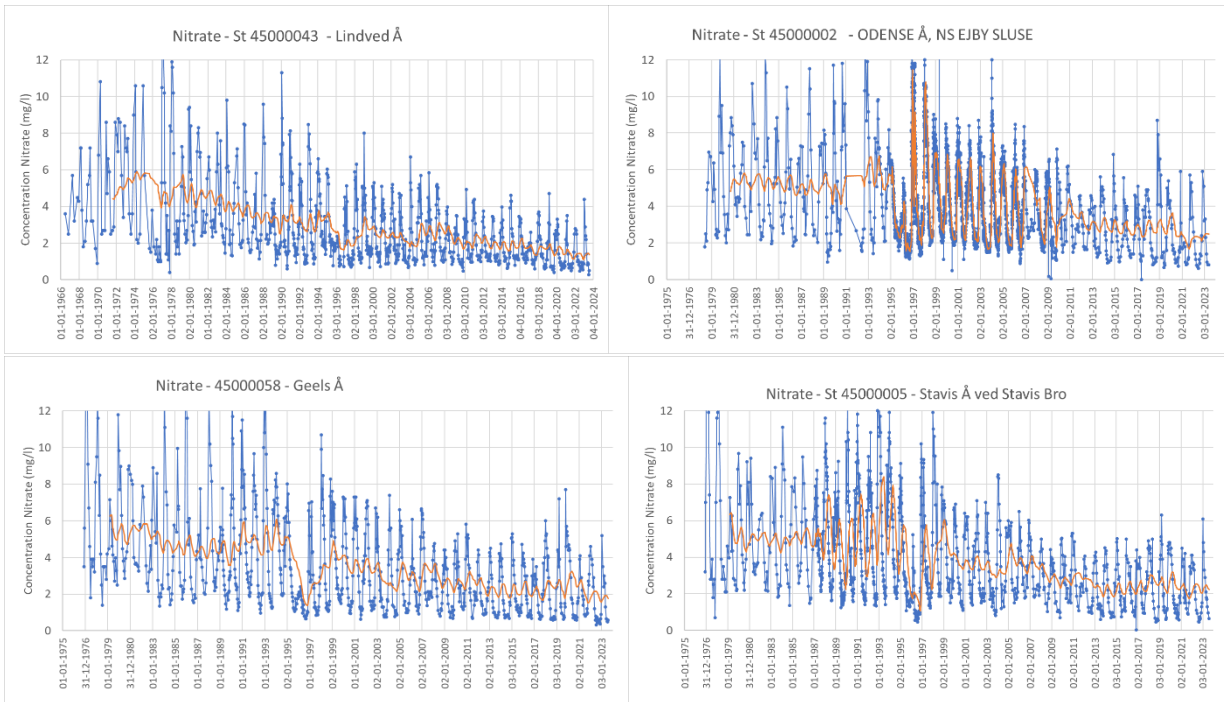

Figure 5. Nitrate concentrations in Lindved Å, Odense Å, Geels Å and Stavis Å from 1975/1966 - 2023.

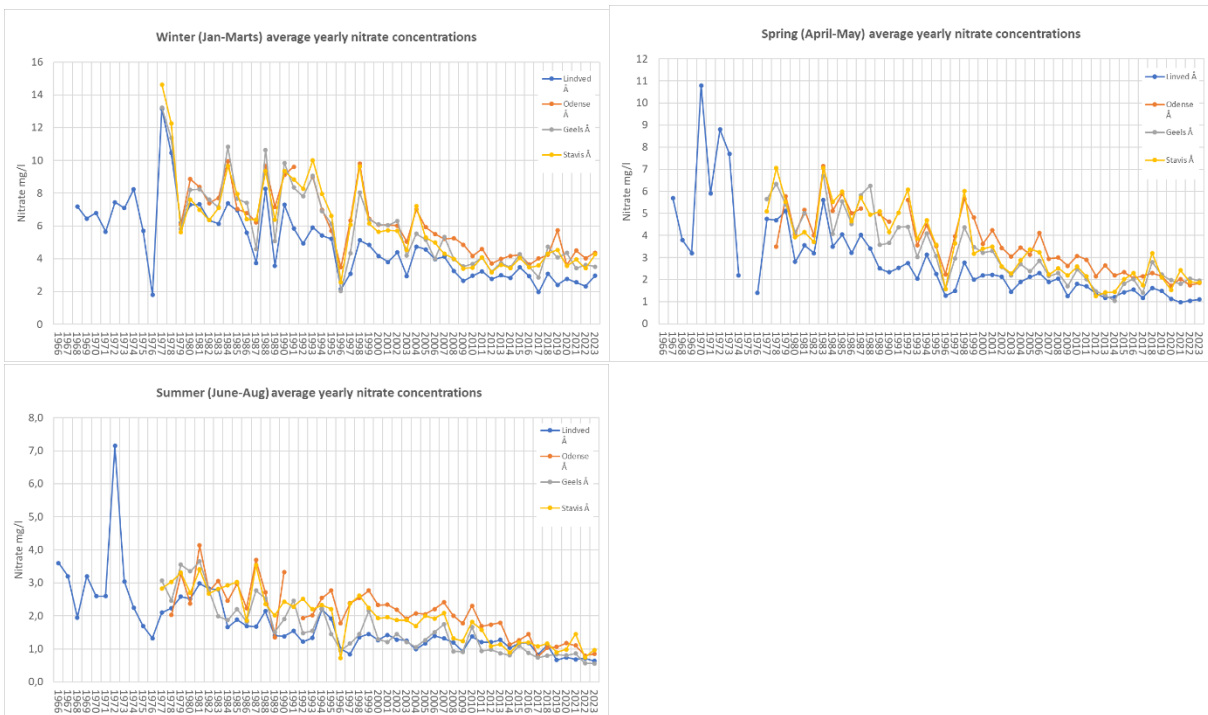

Figure 6. Winter (Jan-Marts), spring (April-May) and summer (June-Aug) average nitrate concentration in Lindved Å, Odense Å, Geels Å and Stavis Å from 1975/1966 – 2023.

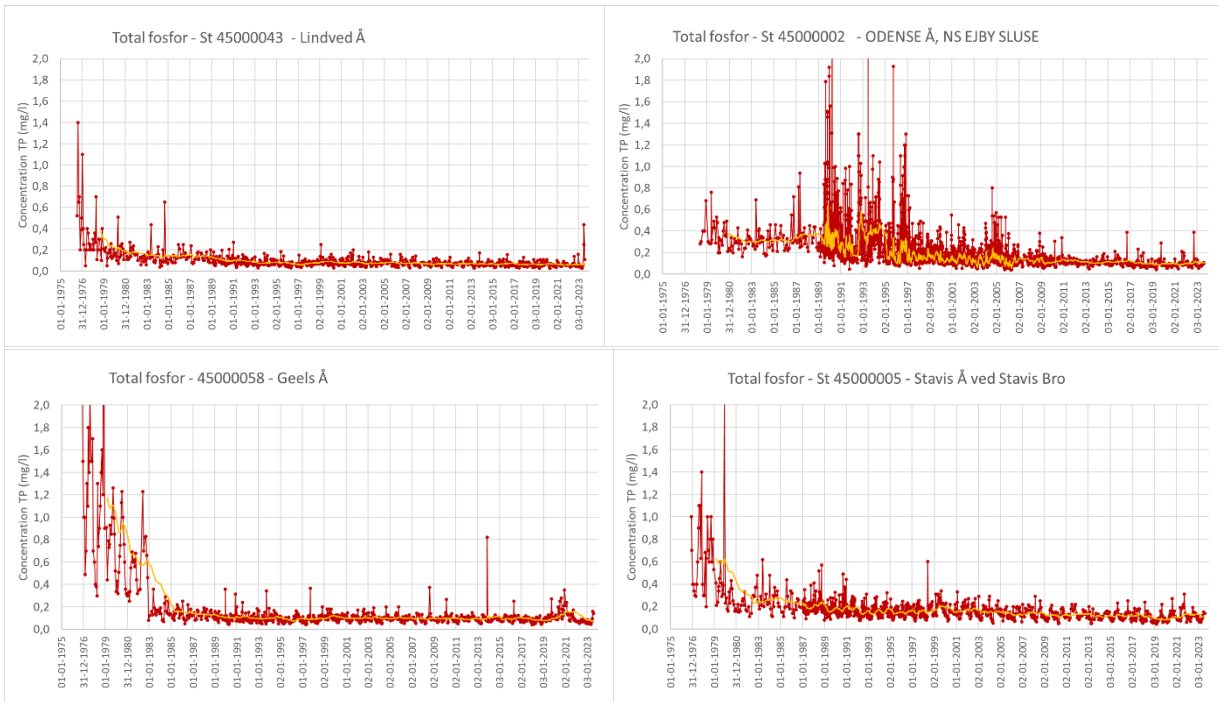

Figure 7. Total phosphorous concentrations in Lindved Å, Odense Å, Geels Å and Stavis Å from 1975 - 2023

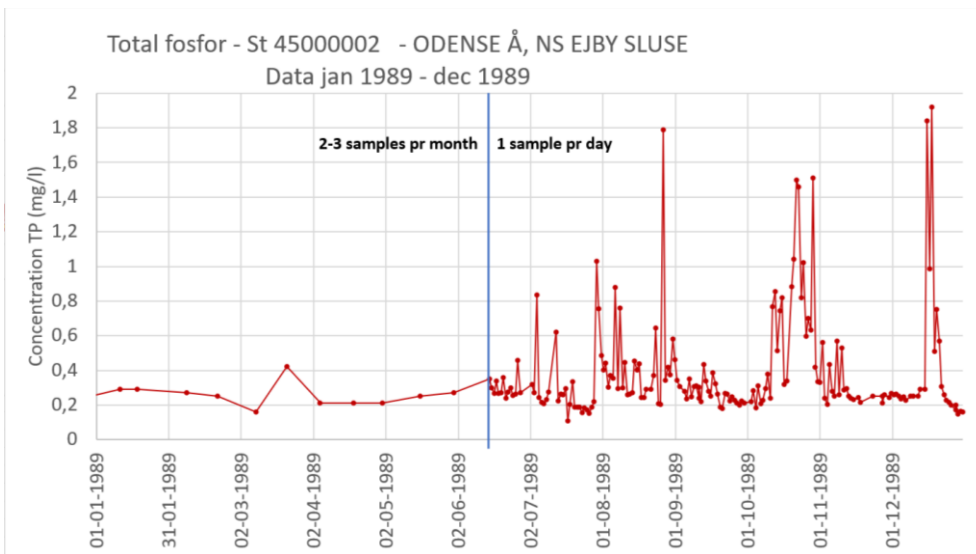

Figure 8. Total phosphorous concentrations in Odense Å illustrating the consequences in concentrations due to change in sample frequency.

Also the TN concentration has great variability throughout the season demonstrated by data collected by University of Southern Denmark in 2023. This variability can be lost when taken fewer samples, and therefore offsets the mass balances. The samples taken by the flow-based automatic sampling equipment was set up to fill one bottle by 8 subsamples. The concentrations measured are therefore an average over the period in which the bottle was filled, usually ~1 day. The peaks registered are therefore likely much smaller than the actual peaks which occurred, as they are a day average. Note that these are concentrations at the outlet of the stream, and the concentration variation in smaller catchment areas is much higher. In the wetter period, the flow may be 4-5 times higher, while the concentration could be 10 times higher than what is typical at the outlet.

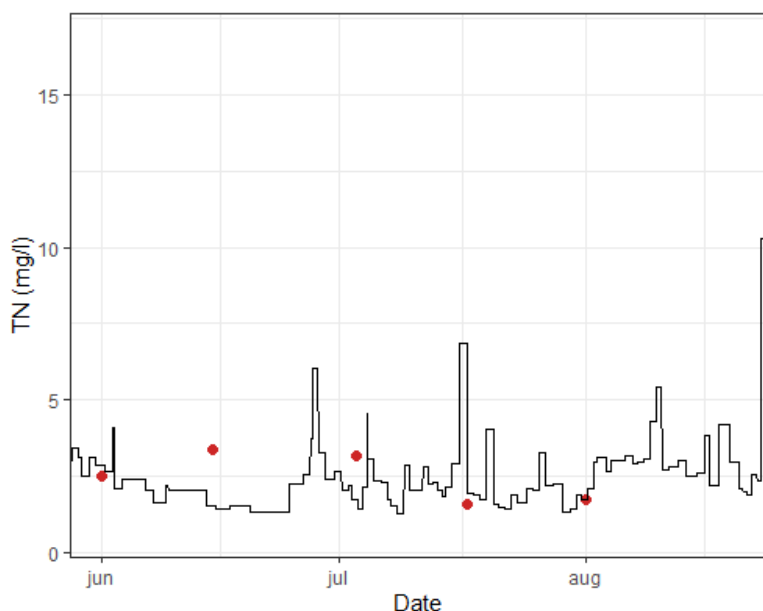

Figure 9. TN concentrations at the mouth of the southern drainage channel of the catchment area to Egensedybet from June to late August. The black line represents concentrations measured by a flow-based continuous automatic sampler, while the red dots represent concentrations measured in water samples collected biweekly by volunteers. Reference and data: SDU.

The total nutrient transport to Odense Fjord has decreased significantly since 1990. Total nitrogen has decreased from approx. 2500 ton TN to approx. 1300 ton TN (Figure 10). In winter months the diffuse contribution is up to 95 % of the total TN loads but that changes and in the summer months diffuse loads decrease to a level similar to point sources (Figure 11).

The phosphorus loads have also decreased both point sources and diffuse sources. The point sources have properly decreased more than shown in Figure 12 due to measures taken on sewage before 1990. The shown decrease in diffuse sources (Figure 12) can be biased by the change in sample frequency (Figure 8). The sample frequency in Odense Å has been changed several times since 1989 and more substantial work must be done to get a better timeline of P-loads to the fjord. Due to relatively low sample frequency in recent years, it is expected that the P-loads and N-loads today are underestimated.

In winter months the diffuse contribution is up to 70 % of the total TP loads but that changes and in the summer months diffuse loads decrease to be half the level of point sources (Figure 13). In reality point sources also vary over time with the highest discharge in winter but not to the same extent as diffuse sources. The point here is that point source contributes significantly to the total loads in the summer period both regarding nitrogen and phosphorous.

The discharge of water from the catchment varies from year to year but there seems to be no overall trend.

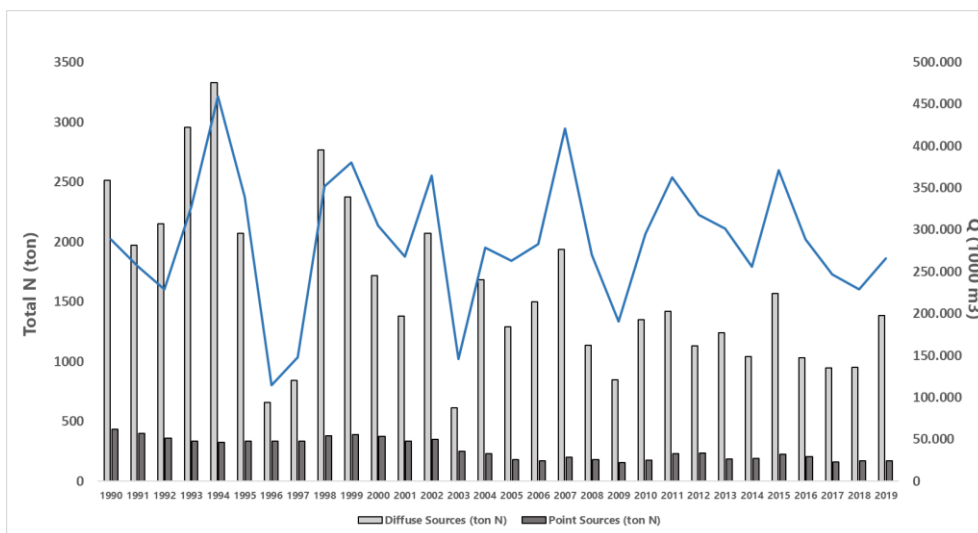

Figure 10. Total, annual nitrogen loads to Odense Fjord, distributed between diffuse sources and point sources. Water transport is marked with a blue line and unit on the right y-axis. Data from Aarhus University.

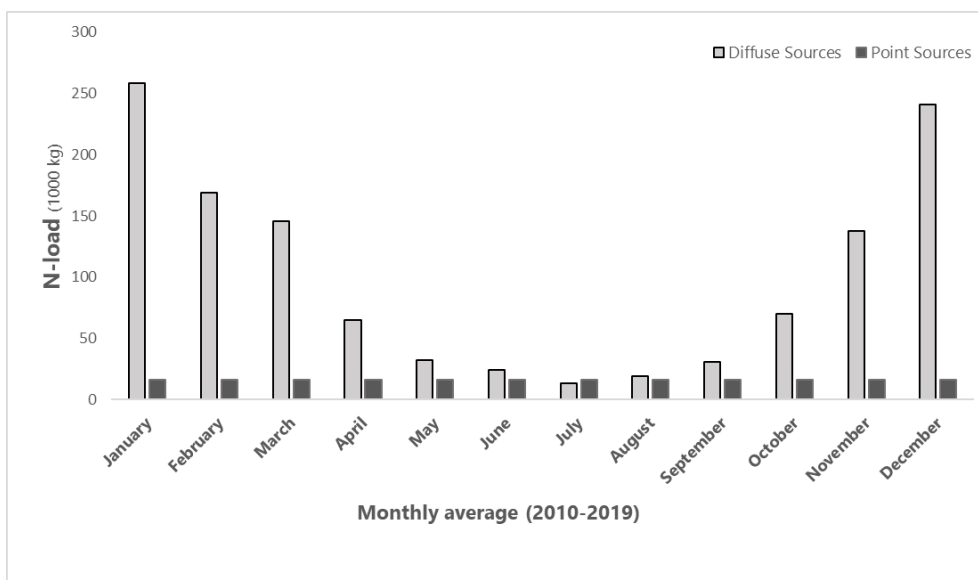

Figure 11. Monthly nitrogen supply to Odense Fjord, distributed between diffuse sources and point sources. Average for the years 2010-2019. Data from Aarhus University.

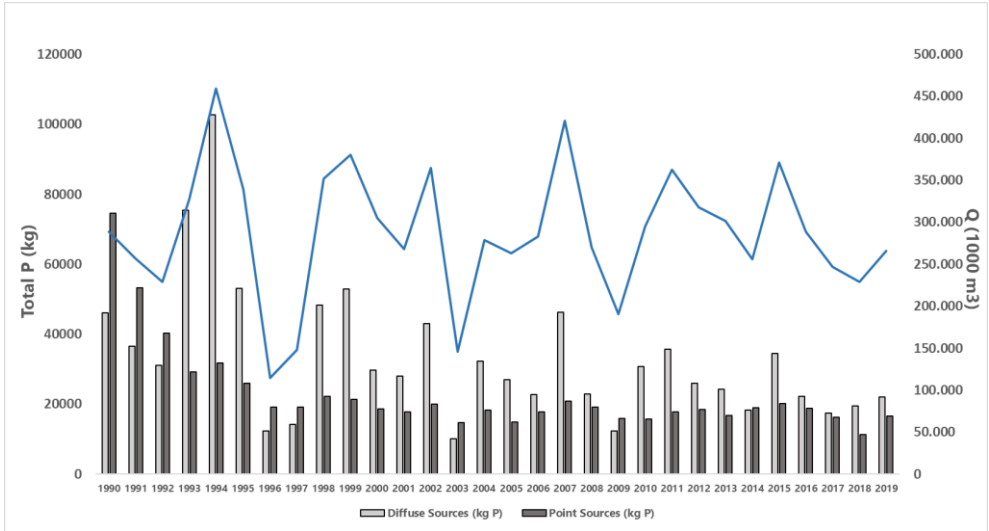

Figure 12. Total, annual phosphorous loads to Odense Fjord, distributed between diffuse sources and point sources. Water transport is marked with a blue line and unit on the right y-axis. Diffuse phosphorous data properly biased by change in samples frequency in Odense Fjord (Figure 8). Data from Aarhus University.

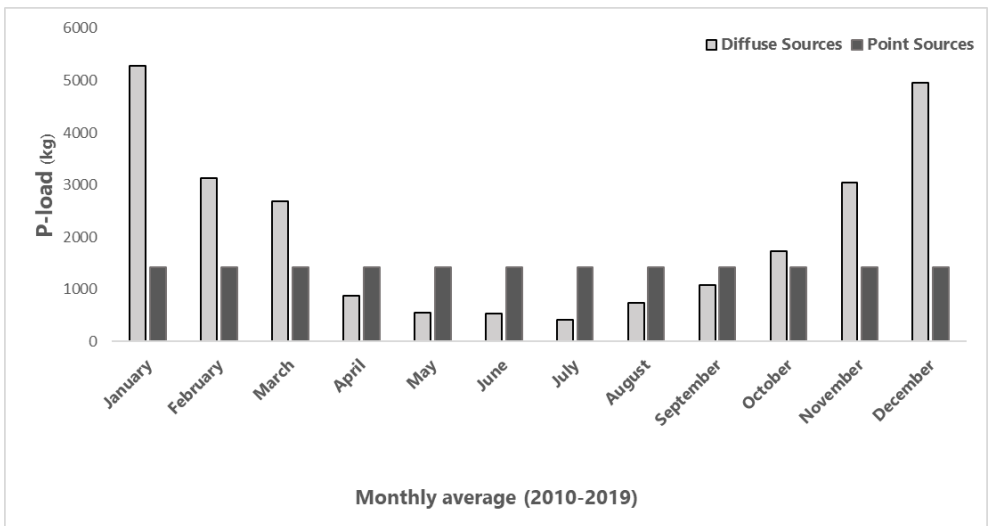

Figure 13. Monthly phosphorous loads to Odense Fjord, distributed between diffuse sources and point sources. Average for the years 2010-2019. Data from Aarhus University.

Hotspotanalyse (AP 2.3)

Note regarding the hotspot-analysis of nutrient transport

Søren K. Lücking, Anders Barnewitz, Theis Kragh & Paula Canal-Vergés

Resumé

Der er udviklet et GIS-værktøj baseret på faktorerne hældningsgrader, jordtype og nitrogen-gødskningsnorm som valideres via en hotspot-analyse i det ca. 42 km² store opland til Egensedybet vest for Odense Fjord. Hver anden uge tages 62 vandprøver fordelt over de to vandløb der går ud i oplandet, samtidig med at to automatiske vandprøvetagere tager kontinuerlige vandføringsbetingede vandprøver samt måler vandføring ved udløbene til fjorden. Der analyseres for DIN, DIP, TOC, TN, TP mm., som benyttes til at beregne næringsstoftransporten fra delområderne.

Background

The development of a new method for monitoring the nutrient transport from the catchment areas to the fjord- and coastal areas was initiated due to the limitations of the current knowledge and data, which is especially apparent in certain sections of the country. The current calculations for the nutrient load to Odense Fjord is based on SWAT-models based on “type catchment areas”, together with monitoring stations at the mouth of the bigger streams, such as Odense Å (Fig. 1). The monitoring stations consists of continuous flow measurements combined with approximately 16 yearly water samples, which is used to calculate the yearly mass balance by interpolating the concentrations between the stations. By using this method, we identify these problems:

- Many catchment areas are not included and are therefore estimated based on models for similar areas. In Odense Fjord, 22% (229 km²) of the catchment area is modelled without measurements in the areas. These areas are primarily the areas closest to the fjord (marked in light green in fig. 1).
- The few water samples across the year fail to capture extreme events, which may heavily impact the nutrient load.
- The catchment areas to the monitoring stations are huge, and their use is therefore limited to monitoring masses, as they cannot give a nuanced perspective on where the nutrients are coming from.
- The catchment areas are usually quite heterogeneous in their contribution to the nutrient load, with some areas contributing much more than others, especially in extreme events of high precipitation.

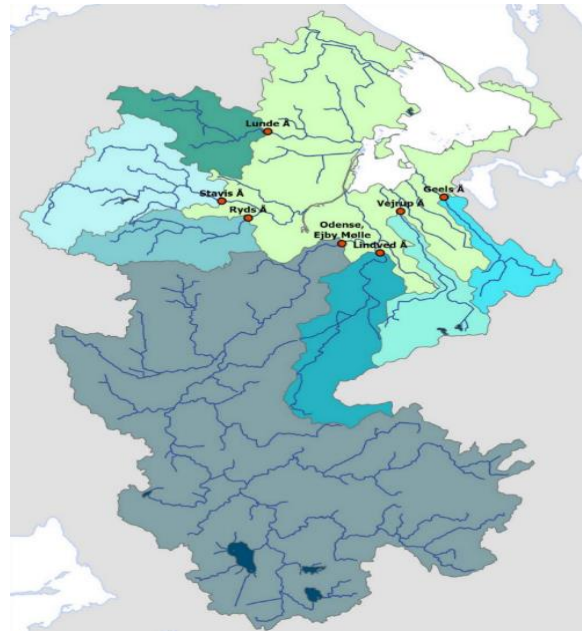

Figure 1 – Odense Fjords catchment area. Current monitoring stations are marked with a red dot. The light-green area has no monitoring station accounting for its nutrient contribution (Aarhus University, 2022).

The new method will be utilized to give the necessary background knowledge in order to construct a GIS-based tool to identify areas of high/low nutrient loading, which can then be applied to other areas. The tool/model will be based on the catchment characteristics such as soil type, topology, agricultural utilization, point sources, nature and area coverage. The area which the analysis is based upon is the catchment to Egensedybet, in the northwest part of the outer fjord.

Pilot area

The catchment area of Egensedybet was chosen as pilot area due to various factors. It has a combination of nature areas, such as the swamp/marsh of Hasmarkmosen, as well as Fjordmarken, which is classified as a coastal meadow right behind the dike which shields the 605 hectares of soil which used to be fjord prior to 1818. The dike, which was built between Bøttingers-Holm (now Hofmansgave) and Bogø (through Ramsø), along with a dike built further south, opened up for the possibility of cultivating large new areas. The new soil was primarily sandy, as it was old fjord, and still today large mussels are visible more than 5 km inland. Fig. 2 shows a map from before the dikes were built (Videnskabernes Selskab, 1776) overlaid with an orthophoto from 2022 (Detektorkort.dk, 2023), with the two channels draining the catchment area marked in red (Northern and Southern channels). The geological and topographic homogeneity (flat, sandy soil) in the catchment area makes it difficult to locate differences in the nutrient load. The observed differences are expected to be largely due to agricultural practices, hence diffuse sources, and point sources. Our aim is to create a model that can locate hotspots for high nutrient loads within this catchment area.



Figure 2 – Historical map (Videnskabernes Selskab, 1776) overlaid with an orthophoto from 2022 (Detektorkort.dk, 2023)

This model needs to be applicable other catchment areas even those with greater geological and topographic variety.

The catchment area to Egensedybet of 43,68 km² (fig. 3) is drained to the outer Odense Fjord through two drainage channels. Both channels are created to drain the surrounding fields and has a highly unnatural course. The Northern channel drains 12.68 km² through a tide-controlled lock, while the Southern channel drains 31.00 km² through a pumping station near Bogø Mølle, a mill which was utilized to drain the area until the pumping station was established. The two channels are connected through the coastal meadow, and an overflow mechanism 4 km away from the mouth of the streams,

which permits water to flow from the northern channel to the southern channel in events of high-water levels. Hofmangave also have two pumping stations draining their own fields, which are also included in this project, adding 3.6 km². Egensedybets catchment area is highly cultivated, about 73 % of the total area is dedicated to agriculture. The main city, Otterup, with its 5250 inhabitants and

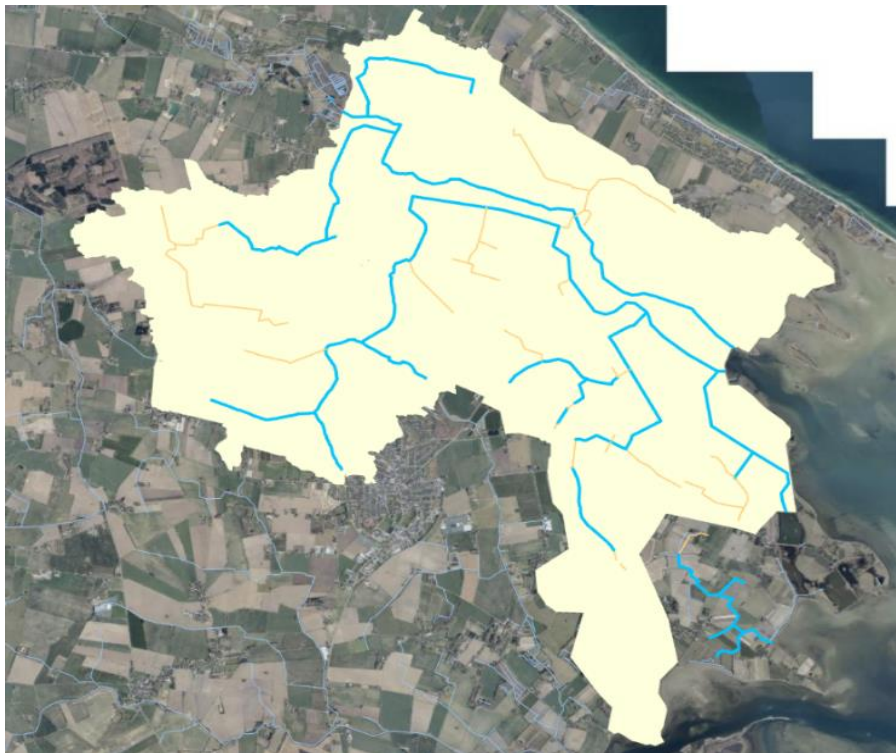

Figure 3 – The catchment area of the project (yellow) with the open drainage channels overlaid (blue), as well as piped drains (orange).

several smaller towns along with farms and housings spread across the area form the urban area of the catchment.

GIS-model

We have developed a GIS tool that incorporated a diverse point sources and diffuse sources to locate potential hotspots in the catchment area with high nutrient loading towards the river. Regarding the point sources, the tool collects all GIS available information in the catchment area which affect the nitrogen and phosphorus load of the catchment. For this catchment area those layers were relevant the location of waste water treatment plants, rainwater ponds, drainage from separated cloak systems or similar (collecting non treated surficial rain water) and diverse industry. Aquaculture facilities which are abundant in other catchment areas in Denmark, were not present in the catchment of Egensedybet.

The estimated diffuse contributions are modeled based on three parameters: Digital Elevation Model (40x40 cm) converted to slope (%), soil type classified into six types (estimated in relation to leaching), and agricultural norms normalized to a four-year average (fig. 4 B, C, and D). The calculation of agricultural norms depends on both field management and soil type, causing this parameter to evolve each year. Nature areas were registered as part of the diffuse contribution, however it was expected they would have a zero or negative contribution. The resolution of the model is seen on fig. 5.

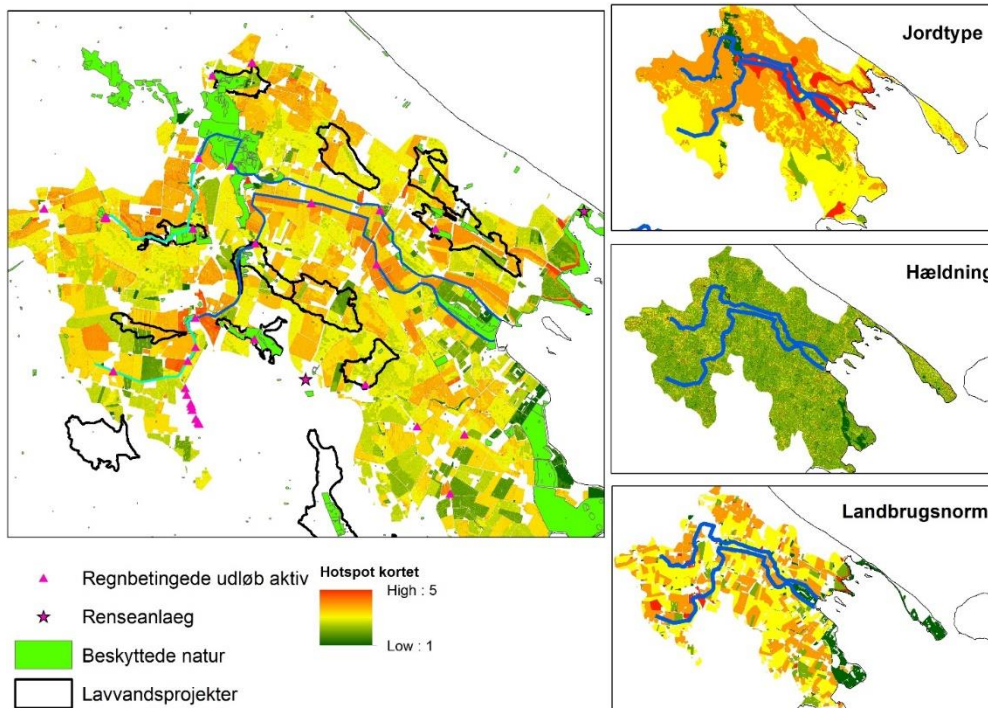

Figure 4 - GIS screening tool for the Egensedybet sub-catchment. A, Provisional hotspot map. B, Soil types. C, Slope. D, 4-year average agricultural norm for agricultural fields.



Figure 5 – Examples of the current status of the GIS-model, ranging like 1 (green) to 5 (red).

Using our GIS screening tool, we can generate a provisional hotspot map, allowing us to focus on specific sub-areas that could potentially prove problematic (fig. 4). Using the provisional hotspot map, we selected 62 stations for monitoring within the catchment of Egensedybet.

The model is expected to require calibration in catchment areas other than the catchment of Egensedybet, as the soil type here is very sandy, and the topography is very flat. Therefore, the primary differences are expected to be in nutrient supply and subsequent leaching affecting nutrient load to the streams in this area. The anticipated leaching in sandy soil is higher than in clay-rich soil (Kronvang et al., 1995), and this is also reflected in the model setup. This is mainly applicable to baseflow during regular precipitation patterns or drought. During extreme events, the effect on a sandy catchment should be reduced compared to a clayey catchment, as sand allows for a larger volume of water to be absorbed over a shorter period than clay, resulting in less surface runoff. This applies to flat catchments as well, where infiltration will be more effective, and there is potential for more depressions to collect water, which may not immediately flush into the channels but percolate through the soil. The most significant change in nitrate quantity during extreme events should be due

to particulate matter. Therefore, the increased surface runoff in clayey catchments is expected to have a greater impact on leaching during these events. A similar tendency is expected, in part, for phosphorus. However, in general, the most significant impact of extreme events or heavy rain is anticipated to be seen in discharges from rain-induced discharges.

Monitoring stations

The 62 chosen stations were selected to calibrate our hotspot model. These stations were placed both before and after various measures, specific fields, and point sources, such as wetlands, mini-wetlands, non-sewered inflows, and before and after parcels identified in the provisional hotspot map (with low or high expected discharge) (fig. 6).

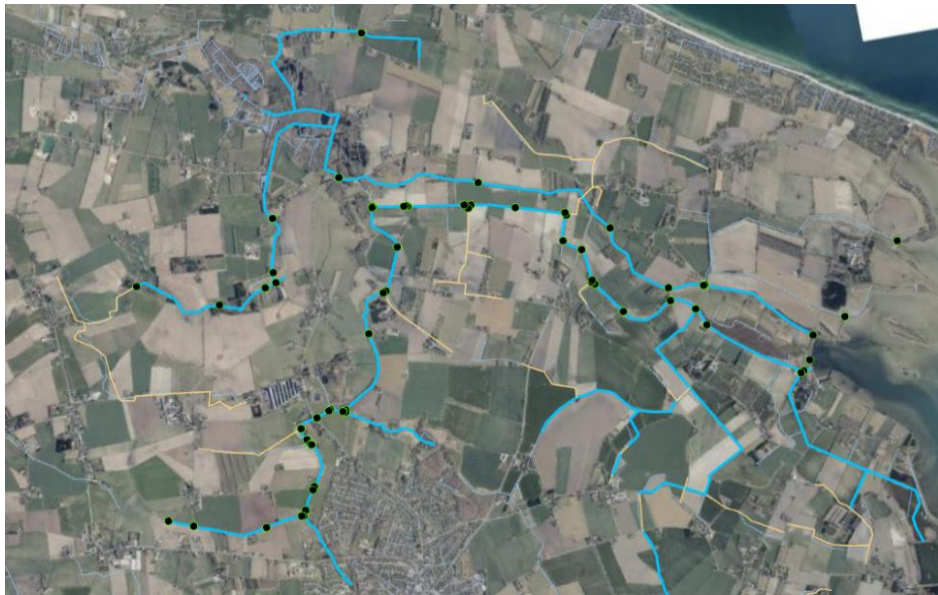

Figure 6 – Placement of the sampling stations in Egensedybets catchment area (black dot with green outline)

The northern and the southern channel in the catchment area stretches 9.5 km and 12 km, respectively. In total, there are 62 stations in the catchment area, including 2 stations at Hofmansgave (fig. 6). Each station has been carefully chosen in order to calibrate our GIS model, following various factors (see below). The maximum distance between stations was 750 meters, except for a few cases where this was not possible due to access limitations.

The stations were placed to represent sub-catchment areas with different characteristics, ex. Accumulation of agricultural land estimated to have a high nutrient load, or drainage from a paved area, main outlet of a wetland.

The station set up was decided under the following considerations:

To investigate the nutrient load from cultivated areas, a sampling station is placed at the beginning of the field and at the end of the field. It is important to pay notice to drained soil, as it may be drained in a different direction than apparent, and for undrained soil, the slope of the given area. In the case of the cultivated area being drained into the channel directly, the method of fig. 7a is used. If multiple cultivated areas are drained into a collector drainage system, method of fig. 7b is used.

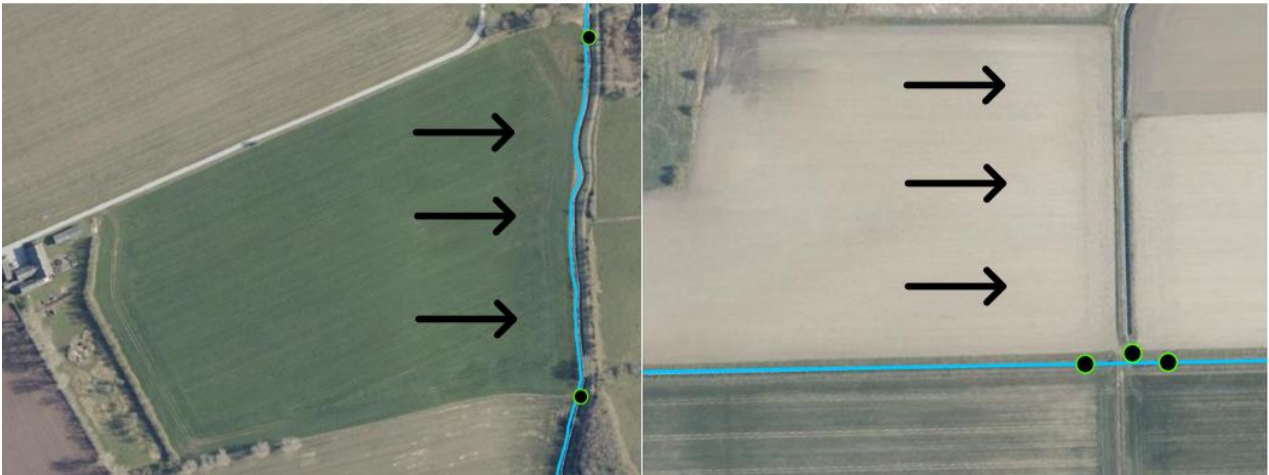

Figure 7a – A field with runoff directly into the channel. Stations placed before and after the field. Arrows indicate runoff direction.

Figure 7b – A field with runoff into a collecting drain, which then leads into the channel. Stations are placed before, in and after the drain. Arrows indicate runoff direction.

When two branches merge, stations are placed in a triangle configuration (fig. 8), with one station in each of the incoming branches and one after the confluence. It is important that the station after the confluence is placed far enough from the confluence to allow for complete mixing of the water. With a triangle arrangement, it is possible to estimate the percentage of water coming from each inlet. Rain-induced discharges and drains can be monitored using both methods mentioned above. For discharges without a visible or accessible outlet, two stations are set up using the before-after method. For discharges with a clear outlet (where measurement at the outlet is desired), the triangle method can be employed (9b). In fig. 9a, under the path, there is an outlet from a separate rainwater discharge with a basin (black circle), which is inaccessible. Stations are set up on each side of the outlet here, allowing measurement before and after.



Figure 8 – The triangle format on of stations at the confluence of two streams.

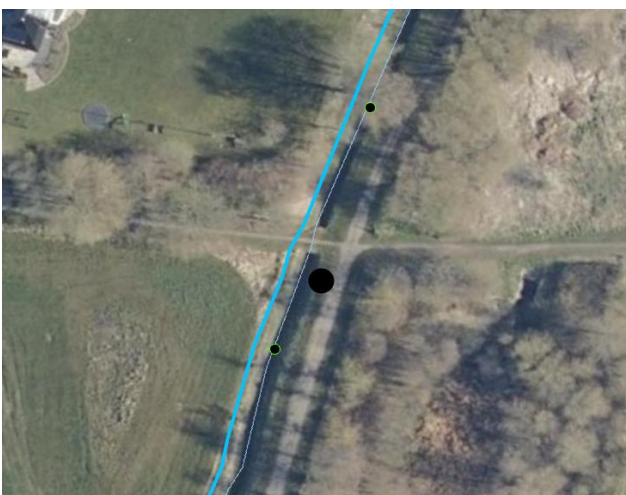

Figure 9a – Inaccessible rain-induced discharge (big dot) with stations before and after (small dots).

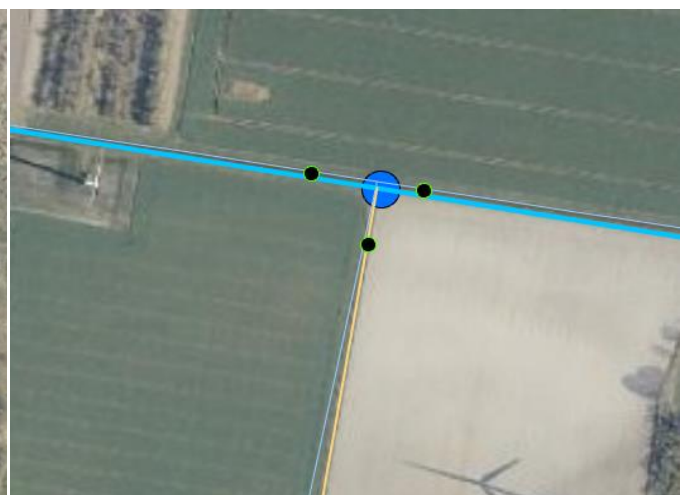

Figure 9b – Rain-induced discharge (piped, orange line) with stations before, inside, and after.

Data collection

The area is monitored by utilizing two methods – at the mouths of the two streams is a continuous flow measurement station which takes regular water samples based on the flow in each channel, and a citizen science part where volunteers collect biweekly water samples from various stations throughout the catchment area, supplied with water samples at extreme events (e.g., cloudburst). To optimize the water collection, the water samples are taken using a telescopic rod mounted with a plastic vial, allowing for water sampling without disturbing the sediment, and without getting into the water. The water samples are frozen after collection and brought to the laboratory at SDU for analysis. For continuous flow measurement and automatic water sampling, a Teledyne ISCO 2150 Area Velocity Flow Module is placed in the stream measuring the water flow by utilizing water velocity, water depth, and a specified area per depth. The measured flow is sent to a Teledyne ISCO 6700 Portable Autosampler which collects water samples into one of 24 bottles. To get an accurate representation of the total mass, smaller water samples are collected into the same bottle, filling approximately 1 bottle (of 8 samples) per day based on the flow. Therefore, fewer water samples are collected in periods of low flow, but in periods of high flow, the sampling frequency increases.

Water sample analysis:

The following parameters are analyzed for further use in catchment analyses and substance transport analyses for the total and specific catchment:

DIN (Dissolved Inorganic Nitrogen):

Individual analyses of nitrate ($\text{NO}_3\text{-N}$), nitrite ($\text{NO}_2\text{-N}$), and ammonium ($\text{NH}_4\text{-N}$) in dissolved form. The analysis indicates the proportion of each type of dissolved nitrogen in the water, which can be used to identify potential sources.

DIP (Dissolved Inorganic Phosphorous):

Analysis of dissolved phosphorus, primarily phosphate (PO_4), in the water. Used to assess the load from primarily wastewater.

TN (Total Nitrogen):

The total concentration of nitrogen in dissolved and particulate forms. Provides an overall figure for the total discharge from specific areas and is used to calculate the mass of substances discharged into the fjord.

TP (Total Phosphorous):

The total concentration of phosphorus in dissolved and particulate forms. Used similarly to TN for phosphorus.

TOC (Total Organic Carbon):

The total concentration of organic carbon in the water. Used similarly to TN and TP.

POC (Particulate Organic Carbon):

The particulate portion of carbon. Used to assess the proportion of particulate carbon relative to the total carbon amount (TOC), which can vary significantly during extreme events.

TDN (Total Dissolved Nitrogen):

The total concentration of dissolved nitrogen, both organic and inorganic.

TDP (Total Dissolved Phosphorous):

The total concentration of dissolved phosphorus, both organic and inorganic.

TDP (Total dissolved phosphorous)

Since different forms of nitrogen and phosphorus serve as indicators for different sources, it is useful to conduct multiple analyses of the specific forms for each sample. Additionally, it is highly relevant

to investigate whether different events (e.g., drought or cloudburst) affect the ratio between, for example, DIN and TN or TOC and POC, to observe how the relationships between dissolved and particulate forms change.

Conclusion

We expect that the model developed based on this project can be utilized for analyses of expected nutrient discharges from large areas, down to the field level. The model is initially set up with three factors: slope, soil type, and nitrate norm. However, in the long term, other supporting parameters are expected to be added. The sampling interval is highly intensive, with many samples per year (approximately 1500 biweekly and 700 continuous samples) and will also be used to assess the optimal sampling interval for a potential similar project. The first step is to identify the major sources in specific catchment areas, enabling a focused effort when implementing nutrient reduction measures. This will require adaptation and validation in other catchment areas to conclude that the model is effective, especially in topographically different catchments and those with different soil type distributions.

References

Kronvang, B., Grant, R., Larsen, SE., Svendsen, LM., and Kristensen, P. (1995). Non-point-source nutrient losses to the aquatic environment in Denmark: impact of agriculture. *Marine and Freshwater Research* 46(1) 167-177

Dataoverførsel til SWAT model (AP 2.6 – første del)

Wastewater data transferred to Odense Fjord SWAT catchment model. Technical note.

Author: Flemming Gertz, SEGES Innovation

Cites: Gertz F, 2023. Wastewater data transferred to Odense Fjord SWAT catchment model. Technical note from SEGES Innovation.

Resumé

Oplandsmodellen for Odense Fjord opland (SWAT+) kører med daglige tidsskridt. Det har derfor været ønsket at få datainput af kvælstof fra spildevand i daglige tidsskridt. Dette er gjort for i alt 6 renselanlæg, der samlet dækker 94 % af renskapaciteten i oplandet. Der er udviklet lineære modeller for sammenhæng mellem flow og udledning af total kvælstof for hver af anlæggende. Modellerne har hver en korrelation med R^2 på mellem 0,67 og 0,87.

På årsniveau giver modellerne omtrent de samme resultater, som en simpel beregning. På månedsbasis ser modellerne ud til at overestimere udledning i sommerperioden og underestimere om vinteren. Denne sommer/vinter bias i modellerne påvirker ikke beregninger for tilstanden i fjord. Til det videre arbejde med at forbedre modellerne foreslås at lave separate modeller til vinter- og sommerperioder.

The Odense Fjord SWAT catchment model runs in daily time steps, and it has therefore been the ambition to deliver daily wastewater loads of nitrogen to the model.

Data have been delivered by Annette Brink-kjær from VandCenter Syd.

Discharge from treatments plants

It has been possible to make models delivering daily loads for the 5 largest treatment plants and in all 6 out of 14 treatment plants covering 94% of the treatment plant capacity in the catchment.

The 6 treatment plants are “Ejby Mølle Renseanlæg” (72 % of total capacity in the catchment), “Nordvest Renseanlæg”, “Nordøst Renseanlæg”, “Søndersø By Renseanlæg”, “Otterup Renseanlæg” og “Hofmangave Renseanlæg”

For each of the 6 treatment plants, it has been possible to establish a linear statistic model based on a correlation between flow and TN discharge. Nutrient concentration samples have been taken approximately 25-30 times per year from the outlet while flow data are available daily. The correlation (Figure 39) demonstrates that there is a significant input of “outside” water entering the sewer system and that decreases the effectiveness of treatment processes Figure 40.

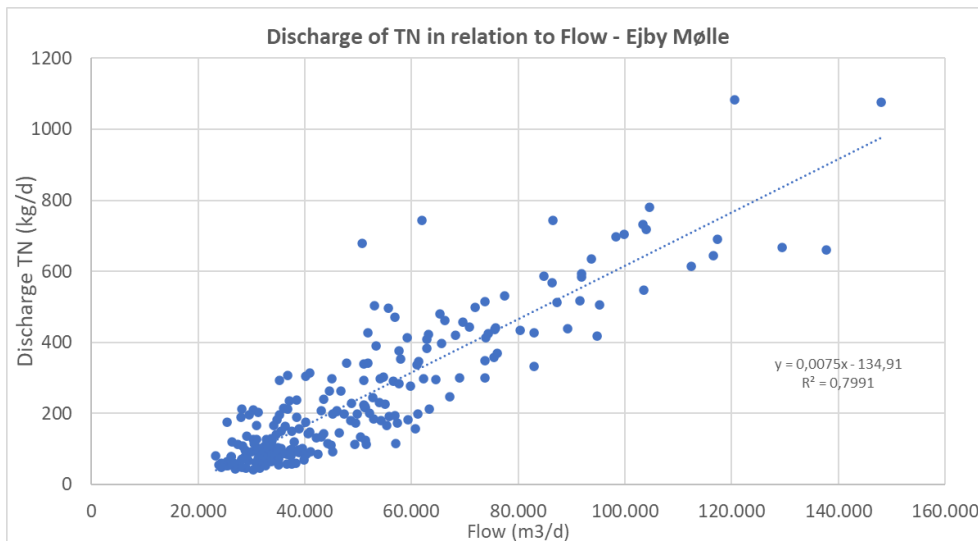

Figure 39. Discharge TN correlation with flow from Ejby Mølle Treatment Plant. Data Oct. 2013 to May 2023

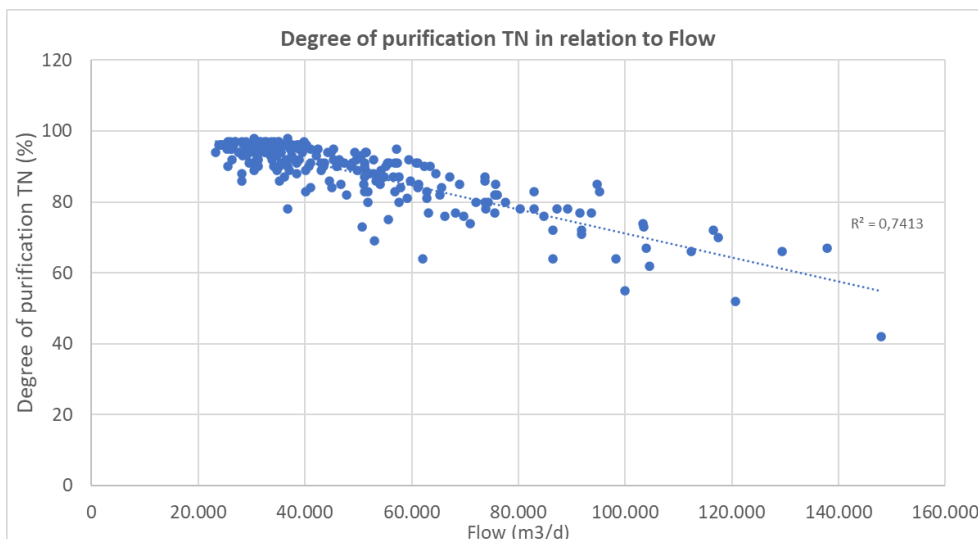

Figure 40. Degree of purification TN in relation to flow. Ejby Mølle Treatment Plant. Data Oct. 2013 to May 2023.

It has been possible to make linear models for all 6 treatment plants with a R^2 correlation between 0,67 and 0,87 (Tabel 3)

Tabel 3: Models for daily TN loads from 6 treatments planets

Treatment Plant	Model	R^2
Ejby Mølle Renseanlæg	$Y=0,0075x - 134,9$	0,80
Nordvest Renseanlæg	$y = 0,0053x - 25,9$	0,67
Nordøst Renseanlæg	$y = 0,0106x - 30,8$	0,87
Søndersø By Renseanlæg	$y = 0,0034x - 2,2$	0,72
Otterup Renseanlæg	$y = 0,0056x - 5,1$	0,62
Hofmangsgave Renseanlæg	$y = 0,0052x - 1,9$	0,76

Results

Using models to estimate daily TN discharge gives a more dynamic picture. With a limited number of samples taken every year periodically high flow events are not covered with samples. Comparing

the model with samples demonstrated a good correlation between models and samples for all models. Model comparisons made for a period at the Otterup treatment plant with extra sampling are shown in Figure 41.

At a yearly level, the model delivers approximately the same results as a simple calculation (Figure 42). While “data only” is based on 25-30 samples per year the model delivers daily loads.

On a monthly basis the model seems to overestimate in the summer period and underestimate in winter (Figure 43) It is not clear to what extent it is the one or the other calculations that are most correct concerning the over and underestimation. This summer/winter bias in the models does not affect the fjord modeling because the changes in the fjord model are relative.

For further work to improve the models, it could be an idea to make separate models for winter and summer periods.

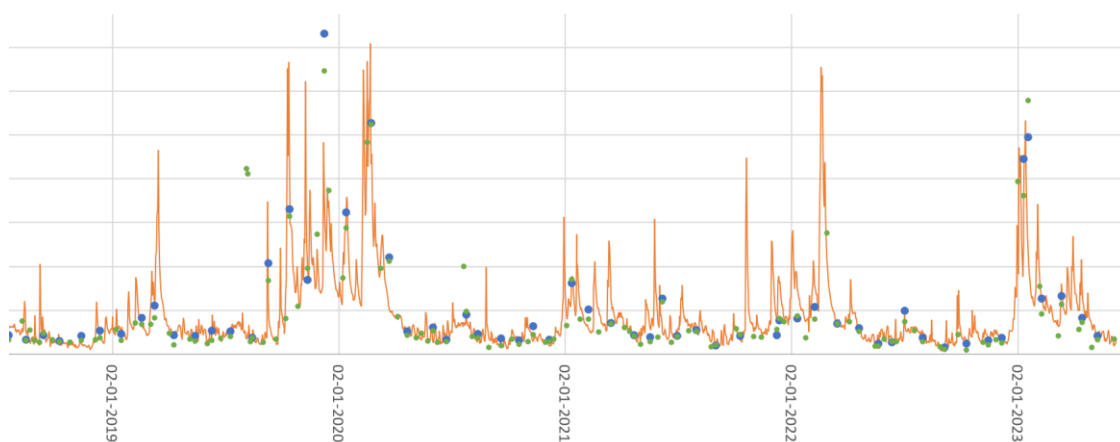

Figure 41. Comparing model (orange) with internal (green) and external sampling (blue). Otterup treatment plant.

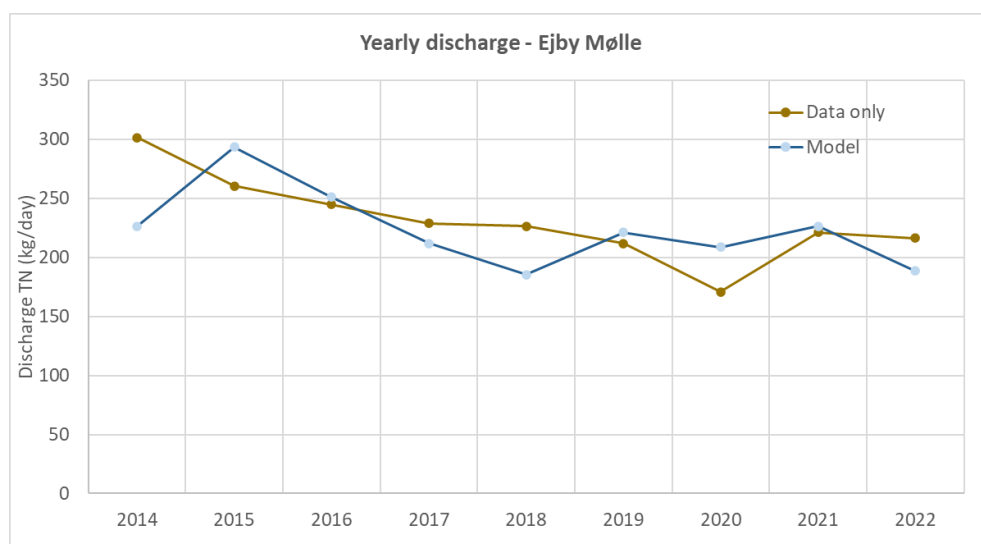

Figure 42. Yearly TN discharge from Ejby Mølle based on data only and from model.

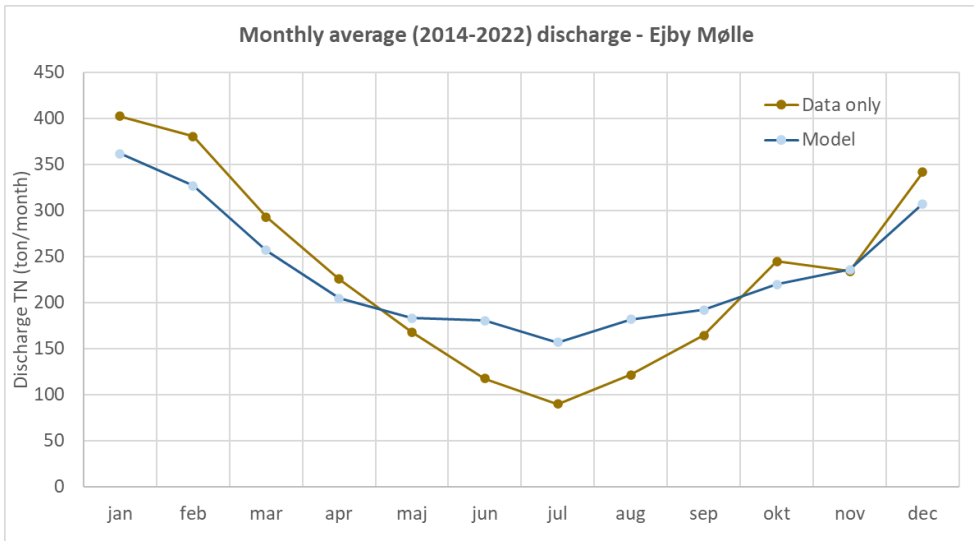

Figure 43. Monthly average TN discharge from Ejby Mølle. Data average data from 2014-2022.

Overflow data

Daily overflow data from 109 points were examined in the catchment of Odense Fjord. These data include daily loads of NH₄ and COD in the period from January 2011 to December 2023. First, the daily loads of NH₄ were summed and ranked in magnitude in order to evaluate the significance of each data point. Figure 6 shows the 20 largest summed daily loads of NH₄ out of the 109 data points, and they are ranked in size in descending order. It shows that the most significant contributions of NH₄ come from very few data points, where the largest contribution is more than 18000 kg NH₄ over the 13-year period, while many of the data points contribute with less than 1000 kg NH₄. Only 8 overflow data points contribute to more than 1000 kg NH₄. In the end, only these 8 overflow data points are used.

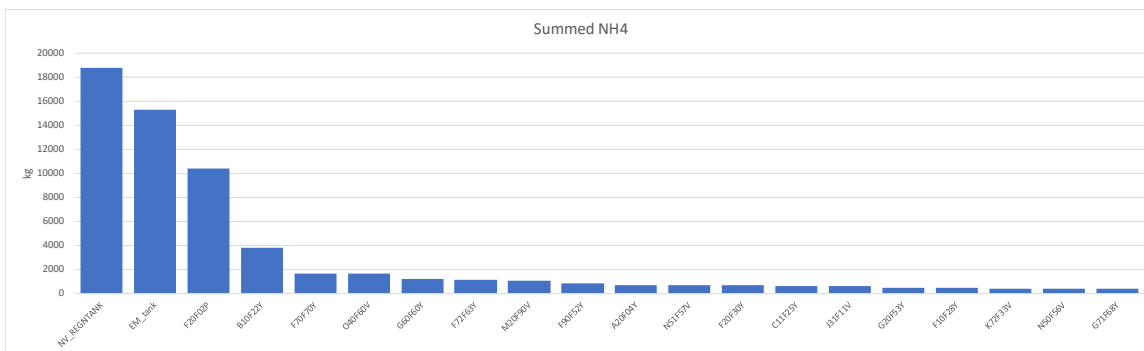

Figure 44. Summed daily loads of NH₄ for the period 2011 to 2023 ranked in size. Note that only the 20 greatest overflow data points of the 109 were included.

The overflow data needs to be converted to organic N, NO₃, and NH₃. First, the TN is calculated by adding 3% of COD (including both COD_{part} and COD_{sol}) to NH₄. Approximately 50% of TN is constituted by NH₄ while the remaining part is divided into 90% organic N and 10% NO₃.

Oplandsmodellering og scenarier (AP 2.4 – 2.5 + 2.7 – 2.9 + 2.11)

Modelling of nitrogen load reduction scenarios in the Odense Fjord Catchment using SWAT+

Forfattere: Katrin Bieger, Aarhus Universitet, Mathias Larsen, SEGES Innovation,

Resume

I dette projekt er der af Aarhus Universitet og SEGES Innovation opsat en SWAT+ model over Odense Fjord oplandet for at undersøge udvaskningen til Odense Fjord ved forskellige scenarier. SWAT+ er en open source-model, som er blevet anvendt til at beregne oplandsbaserede simulationer af vandstrømninger og næringsstoftransporter. Modellen er opsat og kalibreret med inputdata om topografi, arealanvendelse, jorddata, markkort, klimadata samt punktdata fra vandløb og målestationer. Hertil er der også udviklet typesædskeer, som repræsenterer de mest typiske bedriftstyper i Odense Fjord oplandet. Modellen er kalibreret og valideret med målte afstrømninger og næringsstoftransporter fra flere stationer placeret i oplandet. Til modelkalibreringen er der benyttet statistiske metoder såsom Nash-Sutcliffe Efficiency (NSE), procent bias (pbias) og Kling-Gupta Efficiency (KGE) til at udvælge den endelige, kalibrerede model. Efter modelopsætning og kalibrering er der lavet en sensitivitetsanalyse af modellen. Hertil er der opsat 3 ekstremscenarier: et græsmarkscenarie, hvor alle marker er omlagt til permanent græs; et vådområdescenarie, hvor der genoprettes vådområder på hele arealet indenfor ådale undtagen by- og beboelsesområder; et kombineret scenarie, som kombinerer de to forrige ekstremscenarier. Analysen er lavet for at undersøge det fulde reduktionspotentiale i modellen. Resultaterne af ekstremscenarierne gav omtrent det samme udfald i reduktionspotentialet. Til sidst er der kørt et realistisk scenarie, hvor der kun indsættes potentielle vådområder, hvor det er muligt i oplandet. Ved en workshop, afholdt sammen med Kystvandrådet og Odense Fjord Samarbejdet, er der i fællesskab udarbejdet et realistisk kort over potentielle vådområde i oplandet. Da det er vanskeligt at opgøre, hvad der reelt udgør et vådområde i Odense Fjord oplandet i dag, er der lavet to udgaver af potentialekortet. Arealet af vådområderne i to scenarier udgør 11533 ha og 9188 ha, svarende til en arealforøgelse på hhv. 7871 ha og 5526 ha i forhold til baseline. Gennemsnittet af scenariernes resultater er efterfølgende blevet indsendt til DHI, som har kørt fjordmodellen.

Introduction to SWAT+

The Soil and Water Assessment Tool (SWAT; Arnold et al. 1998) model is a river basin scale model specifically developed for predicting the effect of land use and management practices on variables such as flow, sediment, and nutrients under varying soil, land use, and management conditions. It is physically based, computationally efficient, and enables users to study long-term impacts (Neitsch et. al, 2011).

In this study, we used SWAT+, a completely restructured version of SWAT that features several advances in the representation of processes and the configuration of catchments within the model. The most important change is the implementation of landscape units, which allow for routing of flow and pollutants across the landscape. Also, SWAT+ offers more flexibility than SWAT in defining

management schedules, routing constituents, and connecting managed flow systems to the natural stream network (Bieger et al., 2017).

The basic computational unit in SWAT+ is the Hydrologic Response Unit (HRU), which is a unique combination of subbasin, soil type, land use and slope class. The water, sediment, and nutrient losses from each HRU are calculated on a daily time step. Nutrients can be transported to the aquatic environment by surface runoff, lateral flow, tile flow, and groundwater flow (Neitsch et al. 2011).

Input data

The main input data required for setting up a SWAT+ model are topography, a soil map and physical soil properties, a land use map and information about crop rotations and agricultural management, maps of lakes and streams, and time series of climate data (precipitation, minimum and maximum air temperature, solar radiation, relative humidity, and wind speed). For this project, we used the input data listed in Table 1.

Table 1. Input data for SWAT+ model setup.

Input data	Description
Topography	National Digital Elevation Model (32 m x 32 m)
Landuse	Combination of Landuse Map downloaded from MiljøGIS and Field Map downloaded from LandbrugsGIS (10 m x 10 m)
Soils	National Topsoil Texture Map (250 m x 250 m)
Crop rotations and management	2020 farm data from Landbrugsstyrelsen
Streams	Map of streams downloaded from MiljøGIS
Lakes	Map of lakes downloaded from MiljøGIS
Weather data	Corrected DMI precipitation data (10 km grid); temperature and relative humidity at station-level; DMI solar radiation and wind speed (20 km grid)

Each year, the Ministry of Agriculture collects data on field-level crop coverage. In addition, data on farm-level fertilizer and manure N use are collected annually by the Danish authorities for cross-compliance control of farmers. The data from the year 2020 were utilized to derive representative crop rotations and fertilizer and manure application rates for the Odense Fjord Catchment. Subsequently, the agricultural area was divided into farm types, including arable (plant) farms, pig farms, and dairy farms. These farm types were further subdivided based on specific plant type, livestock groups according to the reported usage of nitrogen in organic manure, and conventional/organic production, resulting in a total of 13 unique farm types with one to three unique five to eight-year crop rotations each. The same approach was used by Thodsen et al. (2015). Finally, a farm type was assigned to each field in the Field Map, a map of all agricultural fields in the Odense Fjord Catchment, to obtain a coherent spatial dataset of crop distributions and fertilizer applications at field level for all agricultural areas in the catchment.

		CR1 Seed production conv		CR2 Seed production conv		CR3 Vegetables conv	
Year	Main crop	Catch crop	Main crop	Catch crop	Main crop	Catch crop	
1	Spring barley	Undersown grass	Spring barley	Undersown grass	Peas	Catch crop	
2	Rye grass	Catch crop	Rye grass		Onion	Catch crop	
3	Spring barley		Rye grass	Catch crop intermediate	Peas	Catch crop	
4	Winter rape		Winter wheat		Spring barley	Catch crop	
5	Winter wheat	Catch crop intermediate	Spring barley	Undersown grass	Winter wheat		
6	Winter wheat	Catch crop	Rye grass	Catch crop intermediate	Spring barley	Catch crop	
7			Winter wheat	Catch crop	Peas	Catch crop	
		CR4 Potatos conv		CR5 Cattle >20% roughage conv		CR6 Cattle >20% roughage conv	
Year	Main crop	Catch crop	Main crop	Catch crop	Main crop	Catch crop	
1	Winter wheat	Catch crop	Spring barley		Maize	Catch crop	
2	Potatos		Grass with legume		Maize	Catch crop	
3	Spring barley	Undersown grass	Grass with legume		Spring barley	Undersown grass	
4	Rye grass		Maize	Catch crop	Rye grass		
5	Winter wheat	Catch crop	Maize	Catch crop	Winter wheat		
6	Potatos		Maize	Catch crop	Winter wheat		
7	Spring barley		Maize	Catch crop	Spring barley	Catch crop	
8							
		CR7 Cattle >20% roughage conv		CR8 Cattle <20% roughage conv		CR9 Cattle <20% roughage conv	
Year	Main crop	Catch crop	Main crop	Catch crop	Main crop	Catch crop	
1	Winter wheat	Catch crop intermediate	Spring barley	Undersown grass	Spring barley	Undersown grass	
2	Winter wheat	Catch crop	Grass with clover		Rye grass		
3	Spring barley	Undersown grass	Maize	Catch crop	Rye grass		
4	Rye grass		Maize	Catch crop	Winter wheat		
5	Winter barley		Spring barley	Undersown grass	Winter barley		
6	Winter rape		Rye grass	Catch crop	Winter rape		
7			Winter wheat	Catch crop intermediate	Winter wheat	Catch crop	
8			Winter wheat		Spring barley	Catch crop	
		CR10 Oil seeds and legumes conv		CR11 Oil seeds and legumes conv		CR12 Pigs >80 kg N conv	
Year	Main crop	Catch crop	Main crop	Catch crop	Main crop	Catch crop	
1	Winter barley		Spring barley		Winter barley		
2	Winter rape		Winter rape		Winter rape		
3	Winter wheat	Catch crop intermediate	Winter wheat	Catch crop	Winter wheat	Catch crop intermediate	
4	Winter wheat	Catch crop	Spring barley	Catch crop intermediate	Winter wheat	Catch crop	
5	Spring barley	Undersown grass	Winter wheat	Catch crop	Spring barley	Undersown grass	
6	Rye grass	Catch crop intermediate	Spring barley	Catch crop intermediate	Rye grass	Catch crop intermediate	
7	Winter wheat		Winter rye	Catch crop			
8							
		CR13 Pigs >80 kg N conv		CR14 Cattle derogation conv		CR15 Seed production organic	
Year	Main crop	Catch crop	Main crop	Catch crop	Main crop	Catch crop	
1	Spring barley		Grass with clover		Spring barley		
2	Winter rape		Grass with clover		Rye grass		
3	Winter wheat	Catch crop intermediate	Grass with clover		Rye grass		
4	Winter wheat	Catch crop	Maize	Catch crop	Spring oats		
5	Spring barley	Catch crop intermediate	Maize	Catch crop	Horse beans		
6	Winter wheat	Catch crop	Maize	Catch crop	Spring oats		
7			Maize	Catch crop	Horse beans		
8			Spring barley	Undersown grass	Winter wheat		
		CR16 Cattle >20% roughage organic		CR17 Cattle <20% roughage organic		CR20 Oil seed and legumes organic	
Year	Main crop	Catch crop	Main crop	Catch crop	Main crop	Catch crop	
1	Grass with clover		Grass with clover		Horse beans		
2	Grass with clover		Grass with clover		Winter wheat		
3	Grass with clover		Grass with clover		Spring barley		
4	Spring oats		Spring oats		Peas		
5	Maize		Rye grass		Winter rye		
6	Spring oats	Undersown grass	Spring barley		Horse beans		
7	Rye grass		Spring oats		Spring oats		
8	Winter rye	Catch crop	Winter wheat		Spring barley		
		CR21 Permanent grass					
Year	Main crop	Catch crop					
1	Grass						
2	Grass						
3	Grass						
4	Grass						
5	Spring Barley	Catch crop					

Figure 1. Main crops and catch crops for the most common crop rotations in the Odense Fjord Catchment.

Since the Field Map only includes agricultural land, the land use map for the SWAT+ setup was created by overlaying it with the general Landuse Map. First, both maps were converted to a raster with a 10m x 10m resolution and it was ensured that the grid cells overlay each other exactly. Next, unique grid codes were assigned to each land use type and crop rotation. Finally, the two maps were combined using the raster calculator in ArcGIS. In the resulting combined map (Figure 2), the information from the Field Map was used where available and the information from the Landuse Map map was used for the remaining areas.

Representing all farm types and crop rotations in the SWAT+ setup for the Odense Fjord Catchment would result in a very large number of HRUs, making the model impossible to calibrate due to the direct impact of the number of HRUs on model runtime. Therefore, some of the minor farm types were combined with others and only one crop rotation per farm type was implemented in the model (Table 2).

Table 2. Crop rotations used in SWAT+ for the different farm types.

Farm type	% of catchment	% of agri-cultural land	Crop rotation used in SWAT+
Potato farm with min. 15% potatoes (conventional)	1,45	2,4	4
Vegetables with min 20% vegetables (conventional)	0,97	1,6	3
Seed production with min. 15% seed grass and < 80 kg N (conventional and organic)	2,33	3,9	2
Pig farm < 80 kg N/ha (conventional)	2,00	3,3	13
Pig farm > 80 kg N/ha (conventional)	12,34	20,5	13
Cattle 80 – 170 kg N/ha and < 20% roughage (conventional and organic)	2,27	3,8	5
Cattle 80 – 170 kg N/ha and > 20% roughage (both conventional and organic)	6,58	10,9	5
Plant farm with > 75% rape + spring seed + winter seed + oilseeds (conventional and organic)	19,99	33,2	10
Grass in rotation	4,77	7,9	21
Permanent grassland	3,35	5,6	21
Not in agricultural production	0,23	0,4	n/a
Fixed landuse (fruit orchards, berry farms, plant nurseries)	2,53	4,2	10
Unknown	0,21	0,3	10
Other	1,17	1,9	10

The amount of fertilizer used for every crop was calculated using a spreadsheet developed at SEGES. The spreadsheet required the average amounts of fertilizer used by the different farm types in the Odense Fjord catchment, which were obtained from the farm-level fertilizer account, which is distributed by the Ministry of Agriculture. The average usage of fertilizer was inserted into the spreadsheet together with the previously defined crop rotations. Based on the farm type, type of manure, crops, and catch crops, the spreadsheet calculated the amount of fertilizer that should be applied to each crop in order to achieve the norm, which was then implemented in the SWAT+ model. The dates for plowing, sowing, fertilizer applications, and harvesting were obtained from an internal report from the StyrN project, which is available at SEGES.

Model setup and parameterization

In this study, we used the QSWAT+ interface (version 2.4.6) for the spatial setup of the model and the SWAT+ Editor (version 2.3.3) for writing the SWAT+ input files.

The first step in setting up a SWAT+ model for a catchment is the “Watershed Delineation”. Based on the DEM, the interface divides the catchment into landscape units and calculates the stream network. For the latter, the user can choose to “burn in” an existing stream network. By lowering the elevation of grid cells that overlap the existing stream network, the burn-in function helps the interface identify the correct location of streams, which is expedient in flat areas like the Odense Fjord Catchment. QSWAT+ uses a user-defined threshold for the stream delineation, which determines the minimum area required to form a channel. A small threshold will result in a very detailed stream network, whereas a large threshold will result in a stream network that only includes larger streams. After testing several thresholds, a value of 3 km² was found to be suitable for the Odense Fjord Catchment. QSWAT+ then delineates the landscape units by calculating the drainage area of each stream section. Several small landscape units within the Odense Fjord Catchment were merged with the next downstream landscape unit to avoid unnecessary complexity in the model setup. Next, the lake shapefile was loaded into QSWAT+ and the channels that were located within lakes were removed. The interface can only include lakes in the setup that are located on the stream network. This was not the case for nine of lakes in the Odense Fjord Catchment, which were therefore removed from the lake shapefile. The final step of the watershed delineation was the division of the landscape units into upland and floodplain areas. QSWAT+ offers different methods for delineating floodplains. Based on visual comparison with the river valley bottom map by Sechu et al. (2021) and a map of lowland soils in Denmark, the branch length method with a slope position threshold of 0.1 (Rathjens et al. 2016) was found to be most appropriate for the Odense Fjord Catchment.

The delineation algorithms used in QSWAT+ can only delineate areas that drain to a stream. However, in coastal catchments, some areas do not drain to a stream, but rather directly to coastal waters. To include these areas in the model setup for the Odense Fjord Catchment, the landscape unit shapefile was edited manually in QGIS and then loaded into the interface as a pre-defined catchment. The manual editing of the landscape units included modification of the outline of some landscape units and addition of three landscape units, whose outline was derived from the ID15 catchments and the coastline of Odense Fjord. The final model setup included 420 landscape units, 197 streams, and eight lakes (Figure 2).

The next step after the watershed delineation is the “HRU Definition”. A total of 20012 HRUs were defined in the Odense Fjord Catchment by overlaying the land use map, the soil map (Figure 3), and a slope class map created based on user-defined slope classes and the DEM.

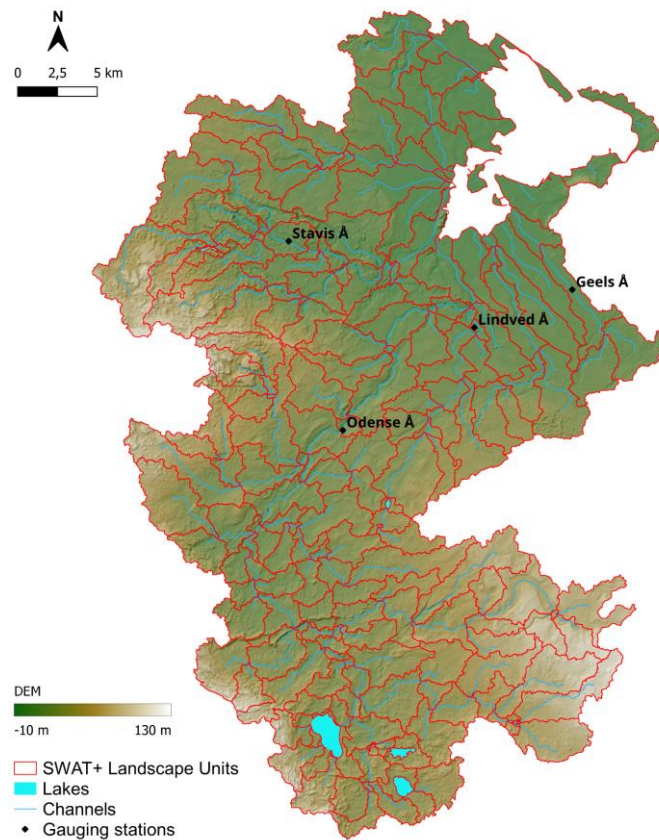

Figure 2. DEM for the Odense Fjord Catchment, Landscape Units (without division into uplands and floodplains) and channel network delineated by QSWAT+, lakes included in the model setup, and gauging stations used for calibration of discharge and nitrogen loads.

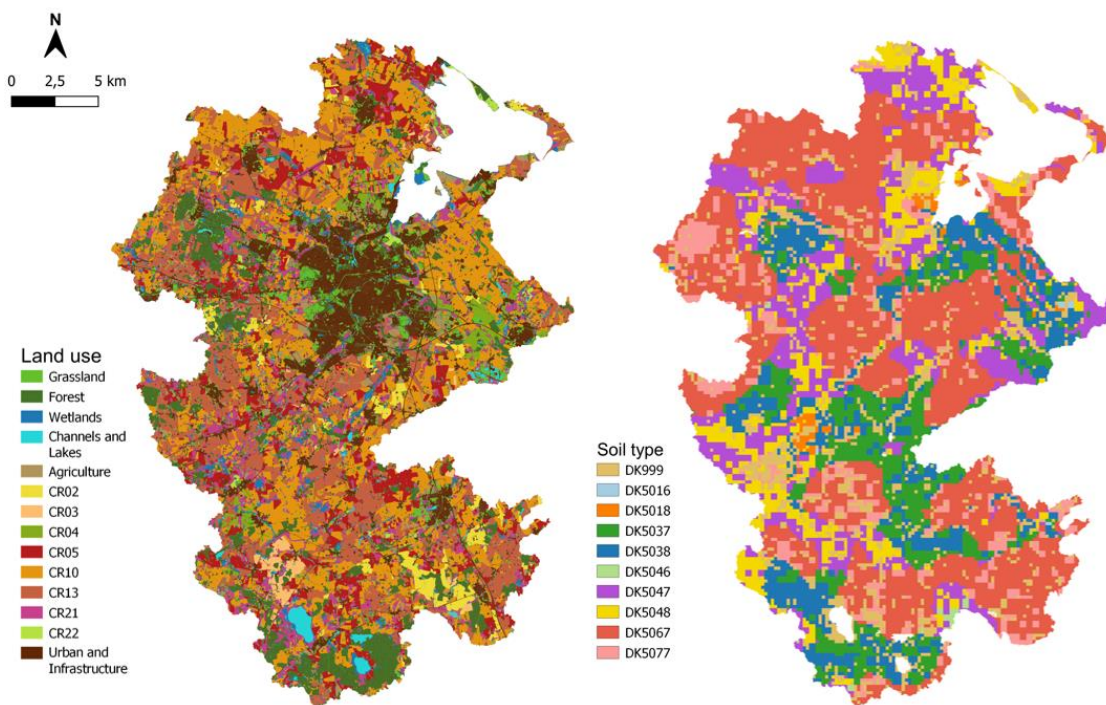

Figure 3. Land use and soil maps used for the SWAT+ model setup

After HRU definition, the weather data was read into the model and all SWAT+ input files were written using the SWAT+ Editor. The default values used by the SWAT+ Editor do not necessarily reflect the specific characteristics of the study area, so some input files for the Odense Fjord Catchment were edited manually before model calibration:

- Subsurface tile drains were implemented in all agricultural HRUs with a mean slope of less than 5%, which resulted in approximately 80% of the agricultural land in the Odense Fjord Catchment being tile-drained.
- The values of three parameters that control the runoff and leaching potential of the HRUs were edited based on recommendations from the model development team as they are not set correctly by the current version of the SWAT+ Editor.
- Management schedules were defined for the different crop rotations implemented in the model. The schedules specify the timing of sowing, harvest, fertilizer and manure applications, and tillage. For sowing and harvest, the user has to specify which crop to sow and harvest. For fertilizer and manure applications, the type of fertilizer or manure, the amount applied, and the application method have to be specified and for tillage operations the type of tillage equipment.
- Point sources were implemented for the ten largest wastewater treatment plants in the catchment and connected to the nearest stream.
- An outlet object was added to the model setup, which summarizes the discharge and nutrient loads from all streams draining into Odense Fjord.

Model calibration and validation

The model was run and calibrated using SWAT+ revision 60.5.7 from October 30, 2023. Both soft and hard data were used for calibration and validation of the SWAT+ model for the Odense Fjord Catchment.

Before calibration, the simulated management schedules and plant growth were evaluated using SWATdoctR, a SWAT+ verification tool developed in R by Svajunas Plunge (<https://biopsichas.github.io/svatools/>). SWATdoctR offers a collection of functions for model diagnostics that are useful for identifying and eliminating input and structural errors in the early stages of the model setup and calibration process. There can be errors in the management schedule file containing the scheduled agricultural management operations that are not easily identified. These errors can result in some of the scheduled management operations not being triggered. Once it was ensured that all scheduled management operations were triggered as intended in the model, the simulated crop yields were compared to the numbers published by Landbrugsstyrelsen (2023). It is important to make sure the simulation of crop growth in SWAT+ is reasonable as it affects the simulation of evapotranspiration, runoff processes, and nutrient transport. The simulated yield was close to the yield norm for spring barley and peas, whereas it was slightly underestimated but still reasonable for winter wheat and corn and overestimated for winter barley. In future modeling efforts, these differences between the simulated yields and the yield norms can most likely be reduced by

adjusting some crop parameters to better represent Danish conditions and the crop varieties grown in Denmark.

After making sure that the simulated crop growth was acceptable, hard calibration of daily discharge and nitrogen loads (nitrate + nitrite) was performed to achieve a good fit of simulated and observed data. Daily discharge data was available for four stations: Odense Å at Kratholm, Stavis Å, Lindved Å, and Geels Å. Daily nitrate loads were only available for Stavis Å, Lindved Å, and Geels Å. The simulation period from 2008 to 2022 was divided into a warm-up period from 2008 to 2010, a calibration period from 2011 to 2016, and a validation period from 2017 to 2022.

Automatic calibration of discharge was performed using SWATrunR, a tool developed in R by Christoph Schuerz (<https://chrisschuerz.github.io/SWATrunR/>). The SWATrunR allows for easy control of essential parameters during simulation runs while also providing parallel processing, which makes calibration of large models much more efficient. For each parameter, 280 values were sampled within the range specified in Table 3 using Latin Hypercube Sampling and simulations were run using the resulting 280 parameter sets.

Table 3. Calibrated parameters, their units, change type (absval = initial value is replaced, abschg = initial value is changed by adding or subtracting an absolute value, relchg = initial value is increased or decreased by a relative value), minimum and maximum value, and final value after calibration.

Parameter	Description	Unit	Change type	Min value	Max value	Final value
surq_lag	Surface runoff lag coefficient	none	absval	0.05	5	0.32
esco	Soil evaporation compensation factor	none	absval	0.1	0.5	0.25
epco	Plant uptake compensation factor	none	absval	0.1	0.5	0.48
ov_mann	Overland roughness (Manning's n value)	none	abschg	-0.3	0.3	0.28
cn2	Curve Number for moisture condition II	none	abschg	-15	0	-8.24
cn3_swf	Soil water adjustment factor for CN3	none	abschg	-0.5	0.5	0.15
perco	Percolation coefficient	none	abschg	-0.5	0.5	-0.12
latq_co	Lateral flow coefficient	none	abschg	-0.5	0.5	0.07
lat_ttime	Lateral flow travel time	days	absval	0.5	20	6.92
dp	Depth of drain tube from the soil surface	cm	absval	800	1200	870.5
t_fc	Time to drain soil to field capacity	hours	absval	10	72	57.74
lag	Drain tile lag time	hours	absval	10	100	54.33

drain	Drainage coefficient	mm/day	absval	10	51	33.39
z	Depth of the soil layer	mm	relchg	-0.5	1	0.18
awc	Available water capacity of the soil layer	mm/mm	relchg	-0.1	0.1	-0.09
k	Hydraulic conductivity of the soil layer	mm/hour	relchg	-0.5	1	0.96
alpha	Alpha factor for groundwater recession curve	1/days	absval	0.001	0.9	0.42
sp_yld	Specific yield of the aquifer	m3/m3	absval	0	0.5	0.25
mann	Channel roughness (Manning's n value)	none	relchg	-0.5	0.5	-0.03

It is recommended to use multiple model evaluation statistics to judge the performance of a model in simulating a variable of interest. Therefore, the Nash-Sutcliffe Efficiency (NSE), the percent bias (pbias), and the Kling-Gupta Efficiency (KGE) were used in this study to rank the 280 calibration runs. The best runs according to the three statistics differed between the four discharge stations, so a run was selected that ranked among the best 40 runs for all stations. In addition to NSE, pbias, and KGE, the Coefficient of Determination (R2) was calculated for the selected run (Table 4). For more information about the model evaluation statistics please refer to Nash & Sutcliffe (1970), Moriasi et al. (2007), and Gupta et al. (2009). In addition to the statistical comparison, the observed and simulated hydrographs were compared visually (Figures 4 to 7). It was also made sure that the landscape water balance for the selected run was reasonable. On a catchment average, actual evapotranspiration was slightly underestimated, but it was not possible to increase it without underestimating discharge at three of the four gauging stations (see pbias values for calibration in Table 4).

Table 4. Model evaluation statistics for daily discharge during the calibration period (Cal) and validation period (Val).

Gauging station	R2		KGE		pbias		NSE	
	Cal	Val	Cal	Val	Cal	Val	Cal	Val
Odense Å at Kratholm	0,85	0,87	0,85	0,90	-12,7	-3,8	0,83	0,87
Stavis Å	0,82	0,81	0,77	0,74	10,7	15,7	0,73	0,70
Lindved Å	0,75	0,86	0,79	0,61	-1,3	15,0	0,66	0,65
Geels Å	0,73	0,87	0,45	0,56	0,1	3,8	0,27	0,62

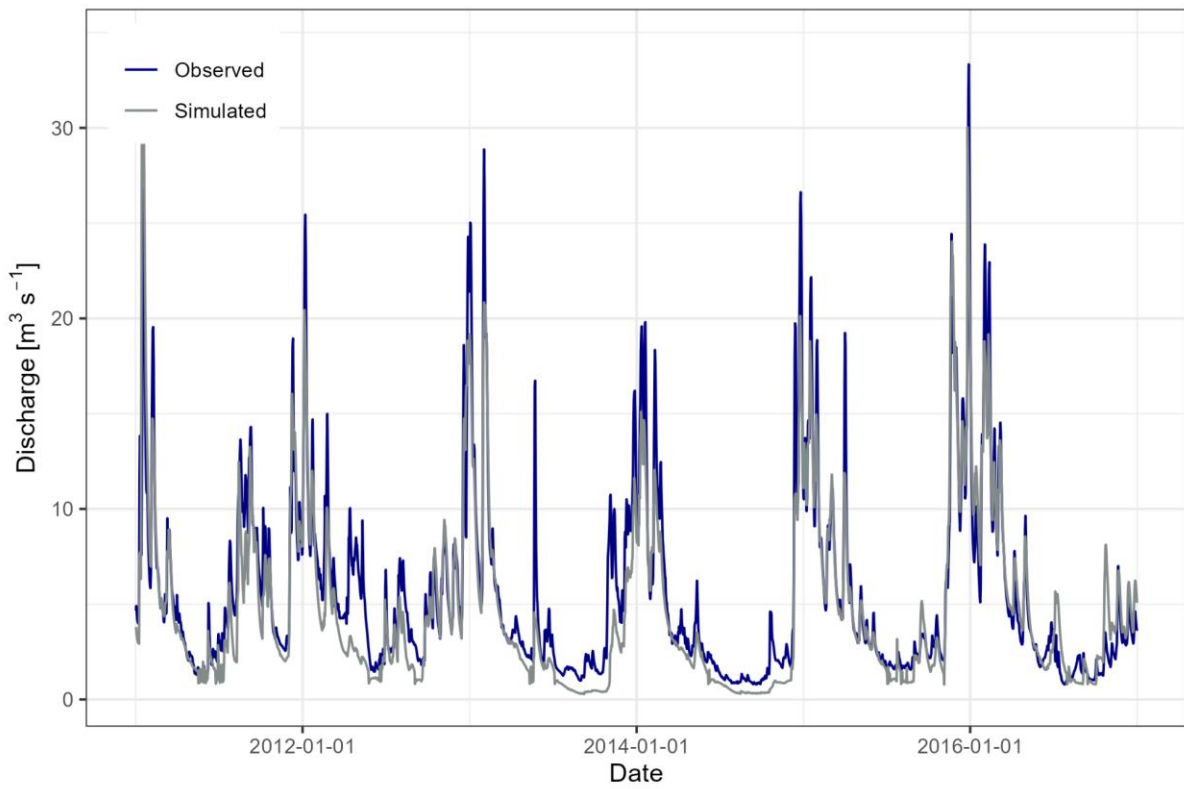

Figure 4. Calibrated discharge for Odense Å at Kratholm.

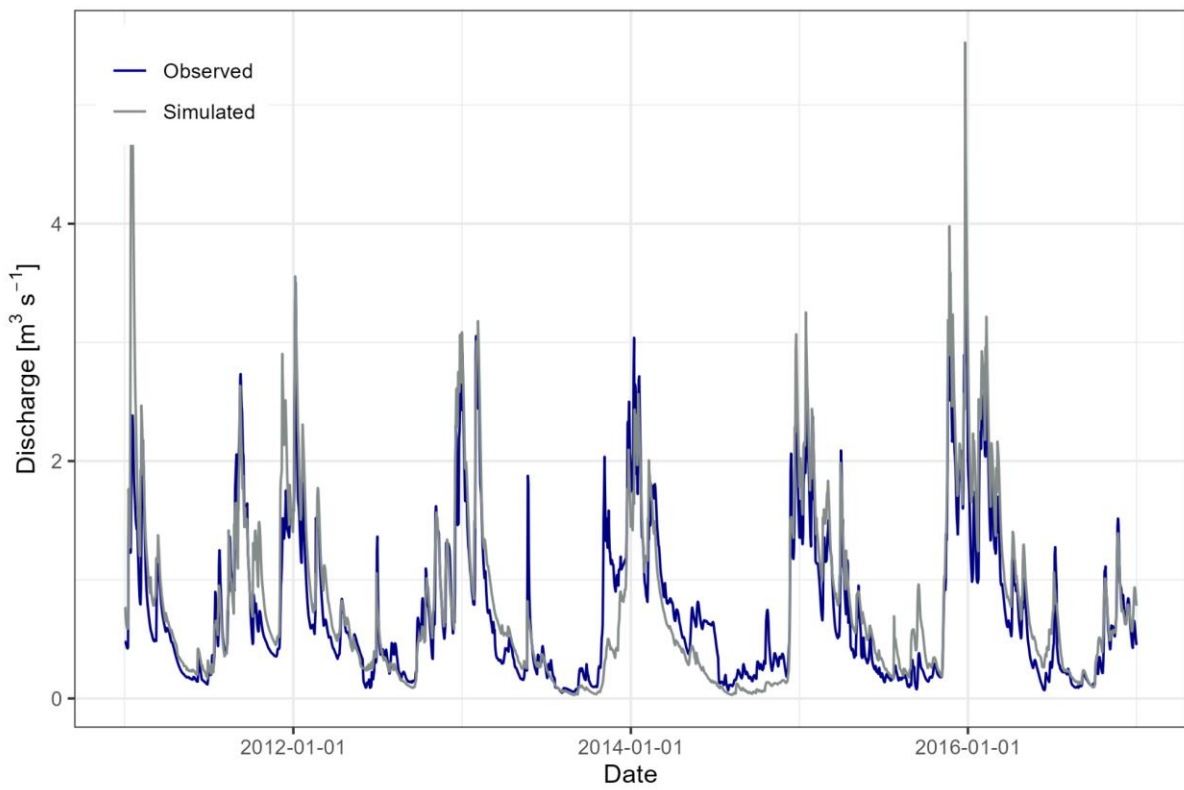

Figure 5. Calibrated discharge for Stavis Å.

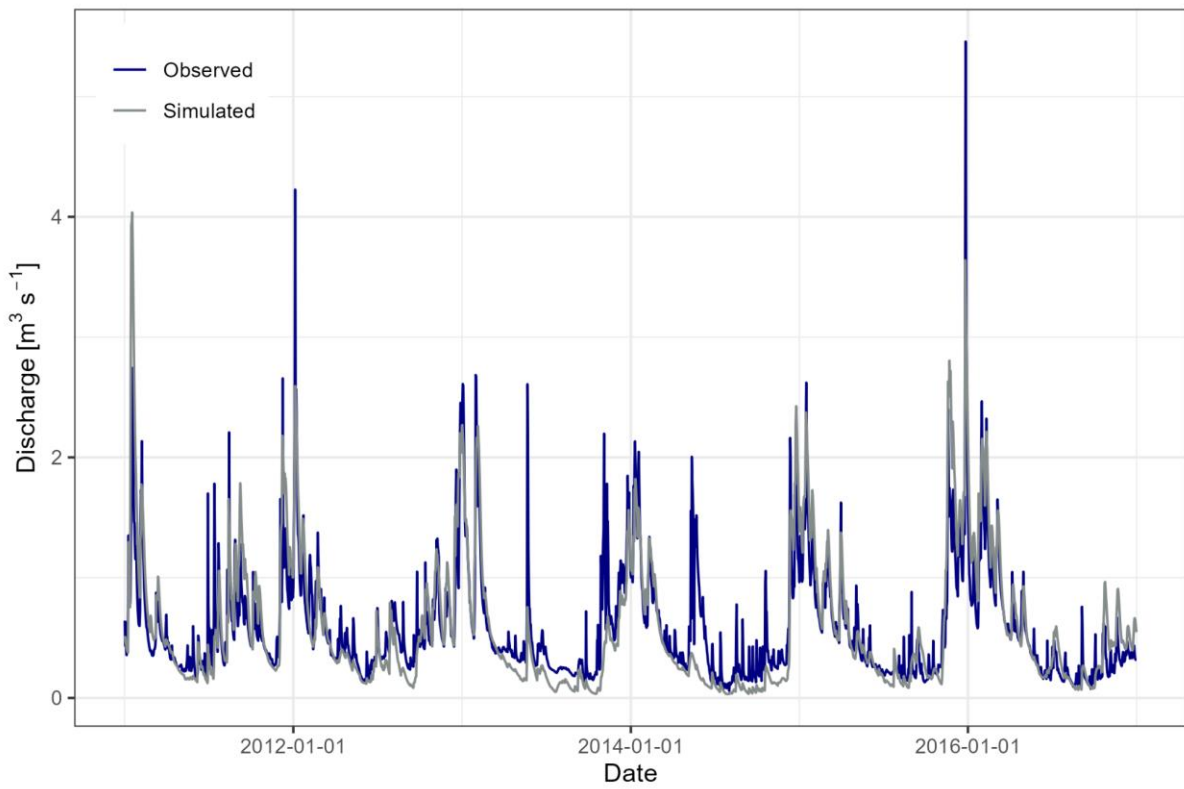

Figure 6. Calibrated discharge for Lindved Å.

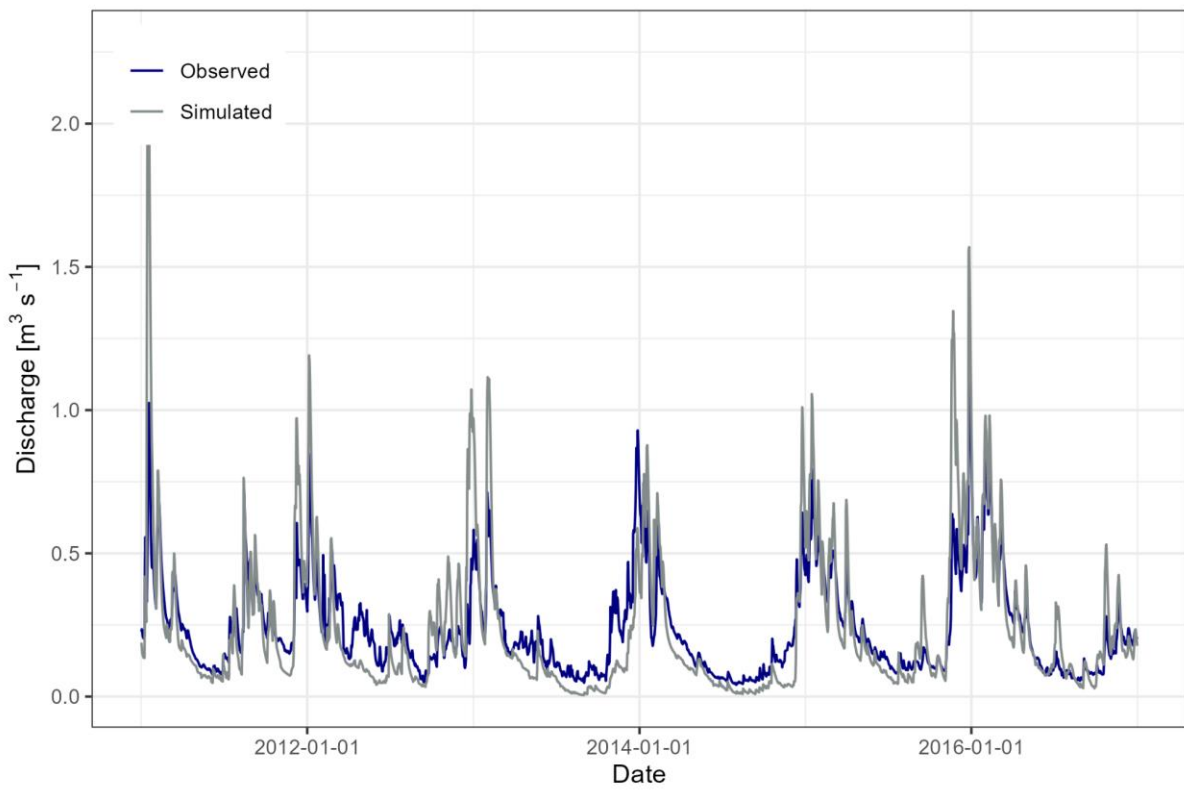

Figure 7. Calibrated discharge for Geels Å.

The nitrogen loads were calibrated manually by adjusting the values of the parameters n_perc (nitrate percolation coefficient), $nperco_lchtile$ (nitrogen concentration coefficient for tile flow and leaching from bottom layer), and $denit_frac$ (denitrification threshold water content). For the nitrogen loads, the model was only evaluated by visual comparison of the observed and simulated data. Due to the infrequent monitoring (roughly bi-weekly grab samples), there is considerable uncertainty in the observed data, so it was considered most important to reproduce the seasonal variability, which was accomplished as the time series in Figures 8 to 10 show.

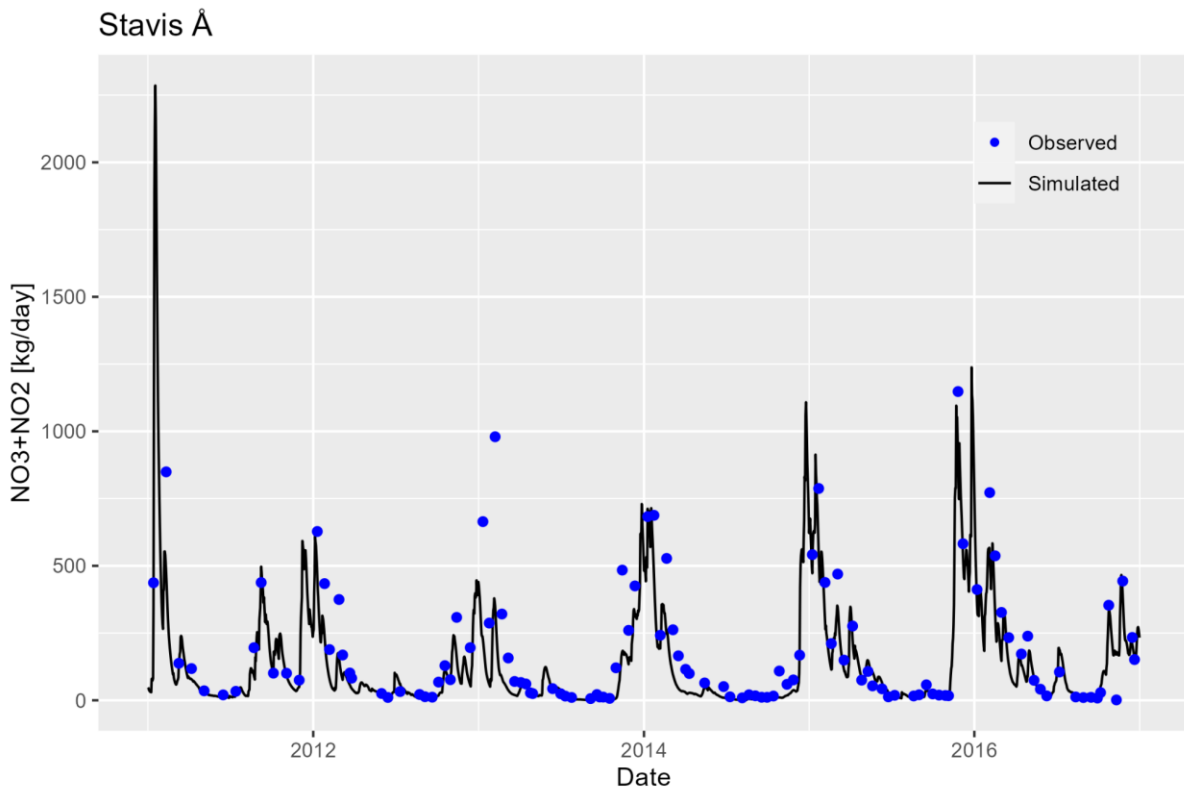

Figure 8. Comparison of observed and simulated loads of nitrate and nitrite for Stavis Å

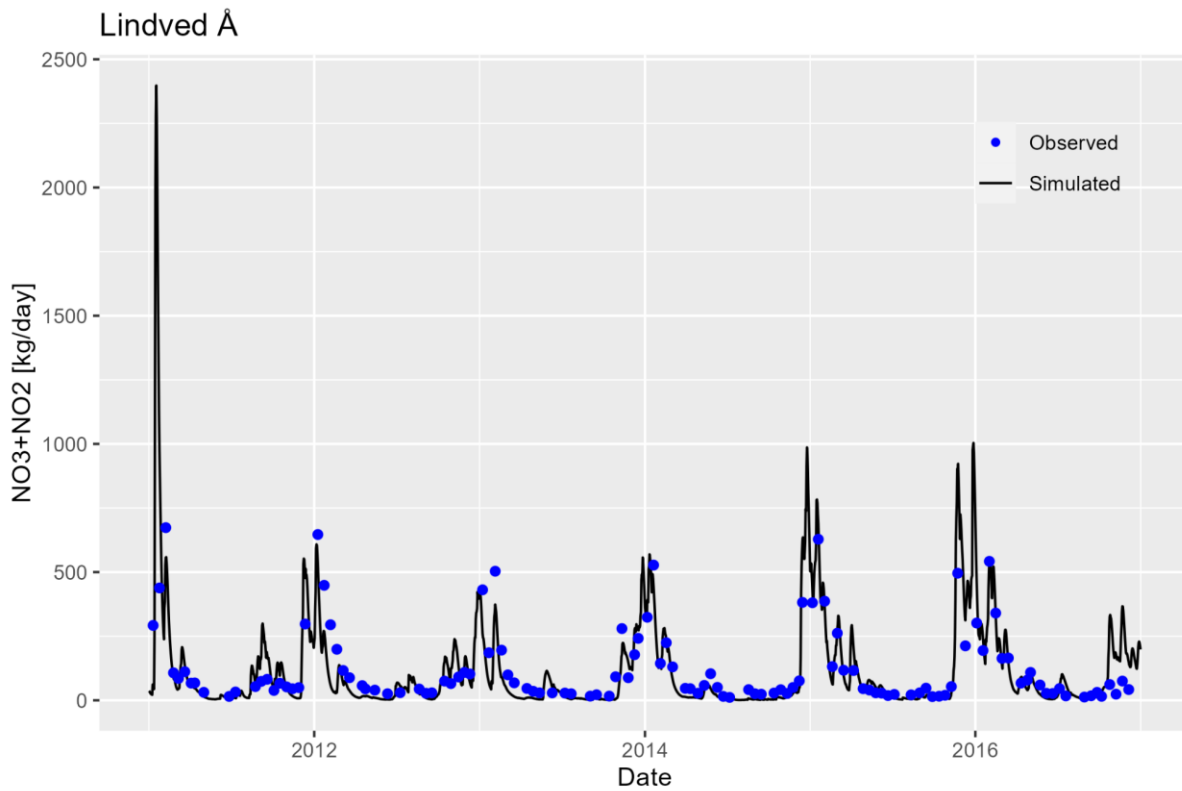

Figure 9. Comparison of observed and simulated loads of nitrate and nitrite for Lindved Å

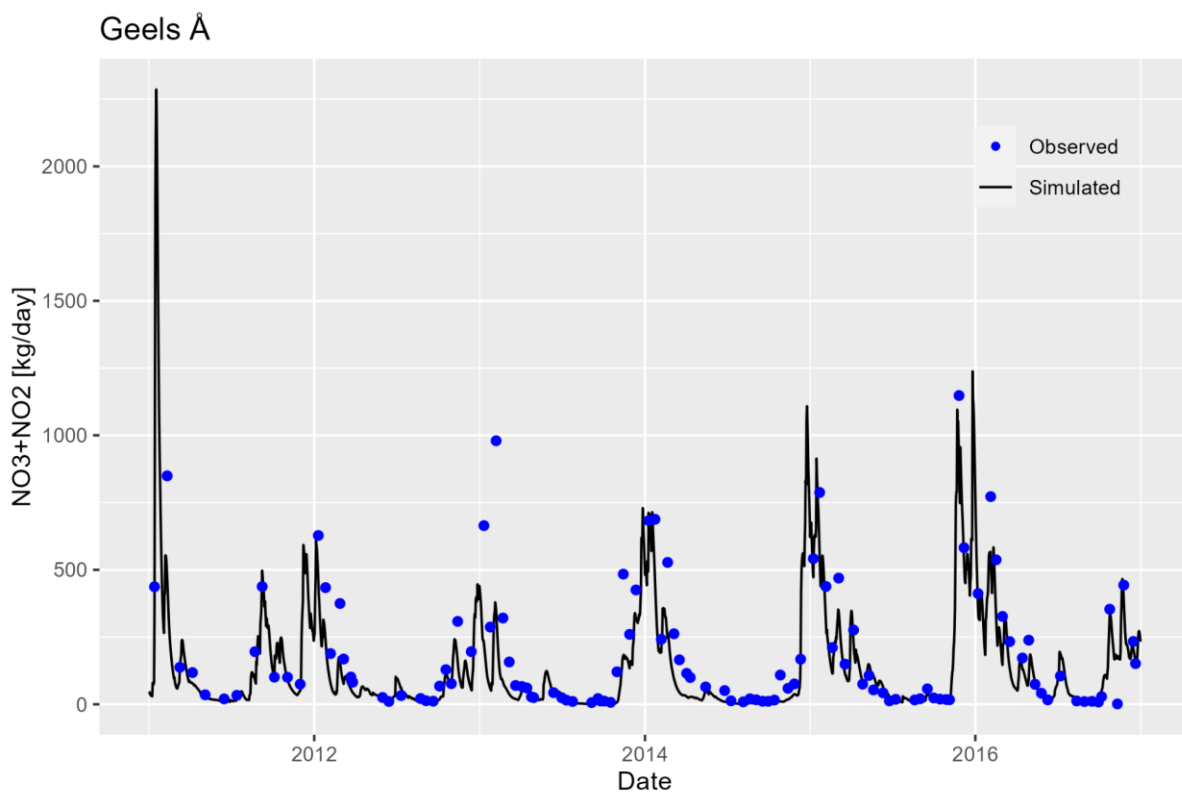

Figure 10. Comparison of observed and simulated loads of nitrate and nitrite for Geels Å

Extreme scenarios

A series of extreme scenarios were defined with the intention of evaluating the sensitivity of the SWAT+ model to changes in land use. This analysis will help illuminate the full nitrate reduction potential that is possible in the Odense Fjord catchment area while also ensuring that the SWAT+ model responds reasonably to changes in the model input.

In total, three extreme scenarios were simulated:

1. Conversion of all cropland to extensive grassland.
2. Conversion of all land uses except for urban land within the floodplain delineated by QSWAT+ to wetlands.
3. A combination of 1. and 2., where all cropland in the upland areas of the catchment are converted to grassland and all land uses except for urban land within the floodplain are converted to wetlands.

The changes in land use were implemented in the calibrated model and the scenario results were subsequently compared with the output from the baseline model, i.e., the calibrated SWAT+ model. Results indicated that the overall reductions in nitrogen loads to Odense Fjord were quite similar for the three extreme scenarios. The reductions in summer nitrogen loads were larger in the grassland scenario than the wetland and the combined scenarios, for which an increase in nitrogen loads was predicted during some summers. However, the reductions in nitrogen loads during the winter and early spring season were larger in the wetland and the combined scenarios. The differences between the three extreme scenarios were largest during the dry summers of 2013 and 2014. The year 2016 was characterized by relatively frequent small flood events, which resulted in relatively high nitrogen reductions even during the summer.

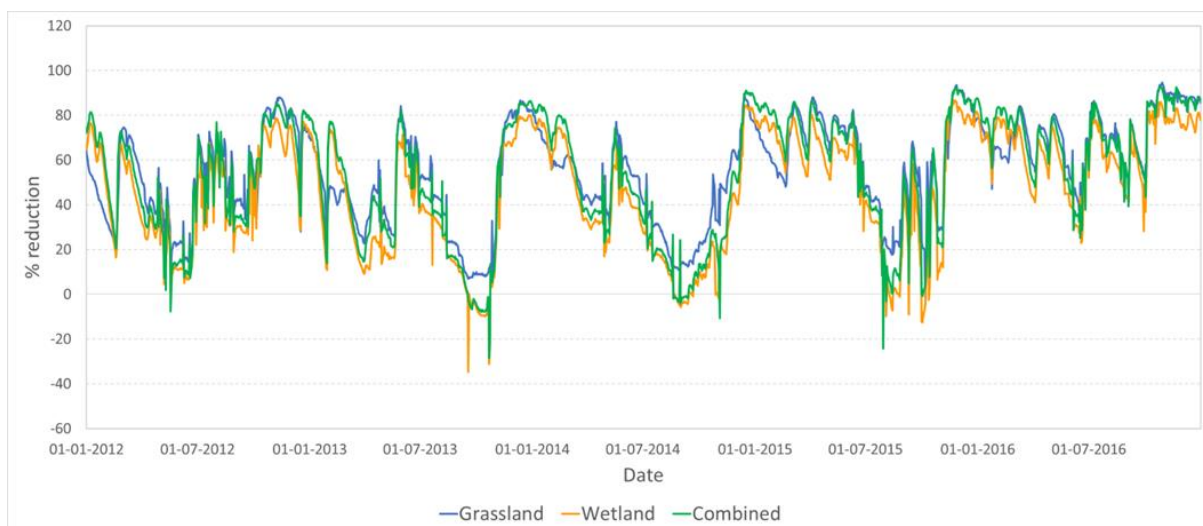

Figure 11. Reductions in daily nitrogen loads predicted by SWAT+ for the three extreme scenarios

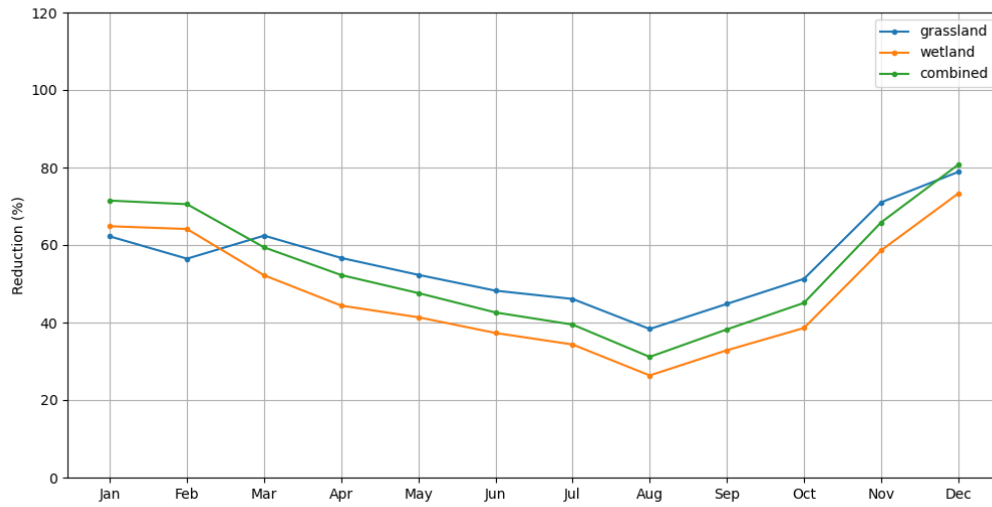

Figure 12. Average monthly means of the extreme scenario reductions

Wetland scenarios

Converting all non-urban areas within the floodplain to wetlands is not feasible in reality. To define realistic wetland scenarios, a joint workshop was held together with Kystvandrådet and Odense Fjord Samarbejdet on the 9th of October 2023 in Odense. At the workshop, the SWAT+ floodplain map was reviewed and areas that are not suitable for wetland restoration were removed (Figure 13). After the workshop, the corrected map was used to identify those HRUs in the SWAT+ setup that should not be changed to wetlands for the realistic scenarios.



Figure 13. Lively discussions during the workshop with Kystvandrådet and Odense Fjord Samarbejdet

However, it was necessary to create two versions of the wetland restoration maps, where additional features were excluded from the map. This is mainly due to the uncertainty concerning knowing what areas are wetlands today. Some river valley areas that have been drained and used for farming are slowly degrading as farmland and it is difficult to have the correct status of the land. In figure 14 and 15, the wetlands areas from VP3 are shown at two locations in Odense Fjord Catchment. At the location southwest of Ringe, the VP3 indicates wetland areas on grass fields which might not actually

be wetland areas. Likewise, at a location northwest of Odense, there is an area which is not shown as a wetland area in VP3 even though the area appears very wet. Thus, there is a small uncertainty on what is actually wetlands today, and this is important to know, since wetland restoration requires knowledge on where the actual wetland areas are today.

Therefore, an “optimistic” and a “conservative” suggestion were made. Both wetland scenarios are excluding the corrections from the workshop as well as areas with infrastructure and roads. However, Scenario 1 excludes the areas that are already defined as wetland areas in SWAT+ while wetland Scenario 2 excludes wetland areas from the VP3 landuse map. The two wetland restoration maps can be seen in Figure 16.



Figure 14. The blue color indicates wetland areas from VP3 at a location southwest of Ringe. Here, some areas are shown as wetland areas which might not be wetland areas today.



Figure 15. The blue color indicates wetland areas from VP3 at a location northwest of Odense. Here, some areas that might be wetlands areas today are not shown as wetlands areas in VP3.

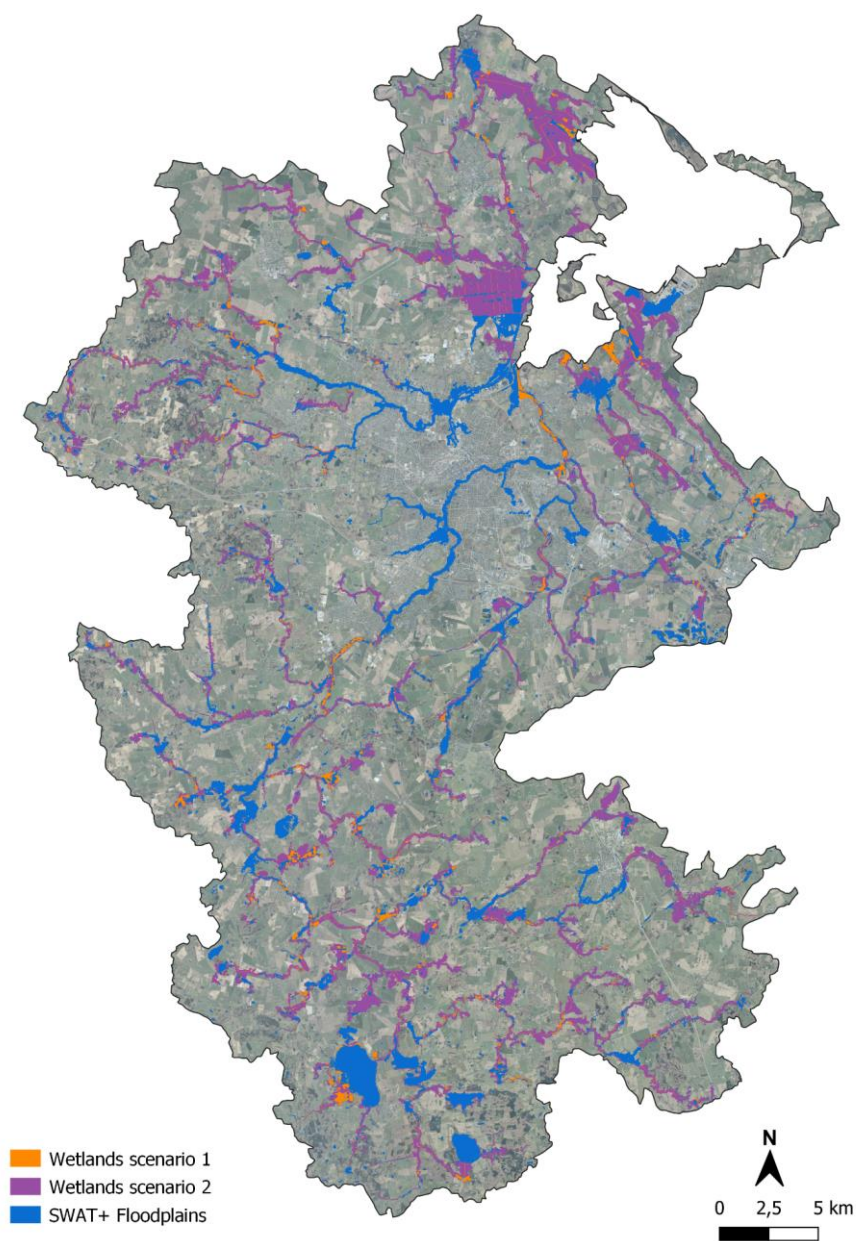

Figure 16. Wetland restoration maps for wetland scenario 1 and 2. Note that the two layers are overlapping, and wetland scenario 2 is slightly smaller than wetland scenario 1.

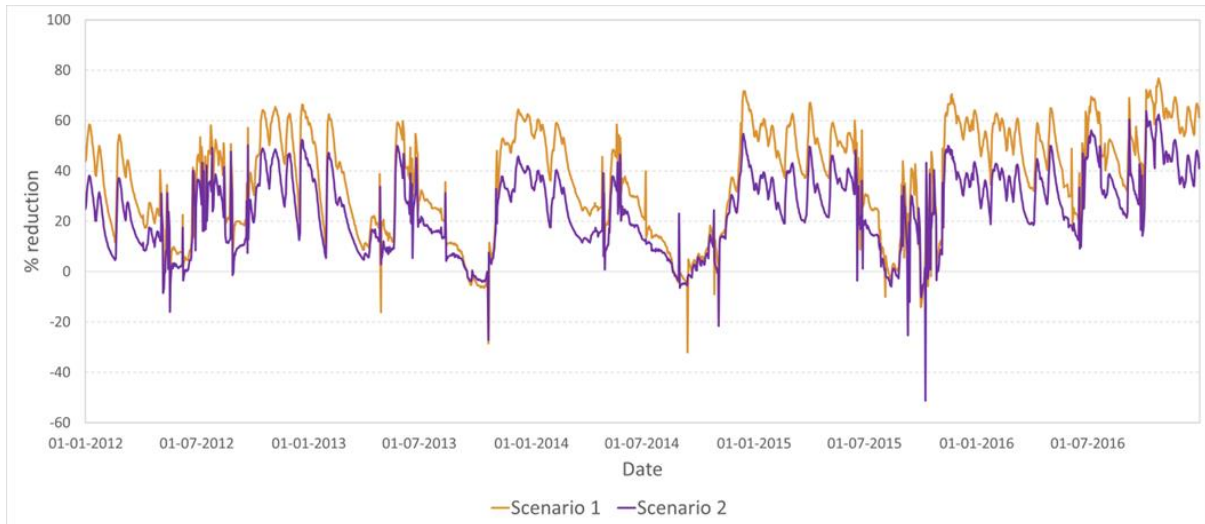

Figure 17. Reductions in daily nitrogen loads predicted by SWAT+ for the two wetland scenarios

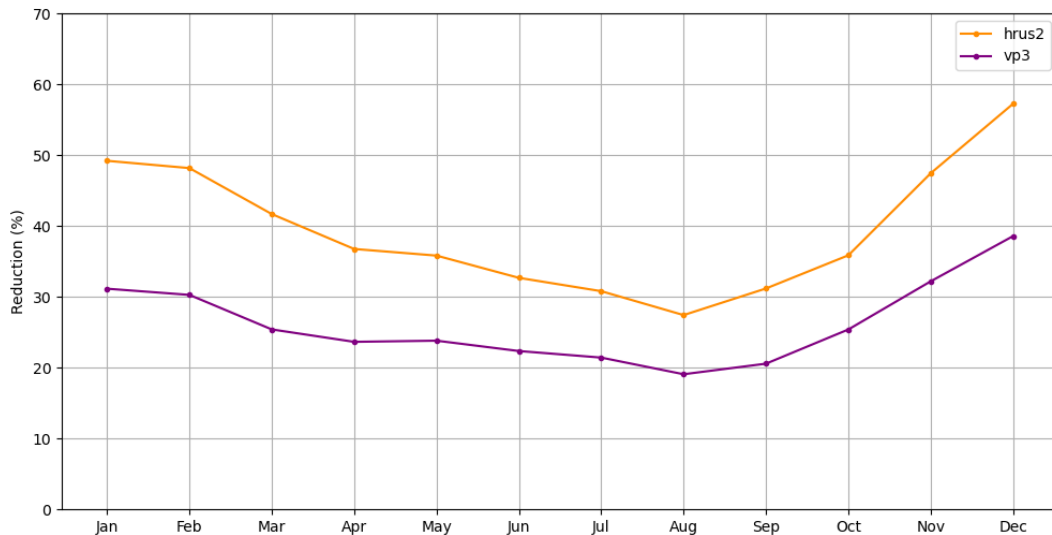

Figure 18. Average monthly means of the wetland scenario reductions

As expected, SWAT+ predicted larger reductions in nitrogen loads to Odense Fjord for Scenario 1 than for Scenario 2. The differences between the two scenarios were smallest during the summer, especially towards the end of and immediately after long dry periods. Similar to the extreme scenarios, there were some periods during the summer where the nitrogen loads to Odense Fjord increased, but the average reduction in August, the month with the lowest reduction, was still around 20 % in Scenario 1 and 15% in Scenario 2. With average values of around 68% and 49% for Scenarios 1 and 2, respectively, the largest reductions were predicted for December. Nitrogen loads during the spring, which are particularly relevant for the nutrient levels in Odense Fjord, were between 20 and 40% depending on the month and scenario.

The final result of the wetland scenarios is an average of wetland scenario 1 and wetland scenario 2, and this will be used for the modelling of Odense Fjord by DHI.

References

- Arnold, J.G., Srinivasan, R., Muttiah, R.S., Williams, J.R., 1998. Large area hydrologic modeling and assessment part I: model development. *JAWRA Journal of the American Water Resources Association* 34, 73–89.
- Bieger, K., Arnold, J.G., Rathjens, H., White, M.J., Bosch, D.D., Allen, P.M., Volk, M., Srinivasan, R., 2017. Introduction to SWAT+, A Completely Restructured Version of the Soil and Water Assessment Tool. *JAWRA Journal of the American Water Resources Association* 53, 115–130.
- Gupta, H.V., Kling, H., Yilmaz, K.K., Martinez, G.F., 2009. Decomposition of the mean squared error and NSE performance criteria: Implications for improving hydrological modelling. *Journal of Hydrology* 377, 80–91.
- Landbrugsstyrelsen, 2023. Vejledning om gødsknings- og harmoniregler Planperioden 1. august 2022 til 31. juli 2023. 161pp.
- Moriasi, D.N., Arnold, J.G., Liew, M.W.V., Bingner, R.L., Harmel, R.D., Veith, T.L., 2007. Model evaluation guidelines for systematic quantification of accuracy in watershed simulations. *Transactions of the ASABE* 50(3), 885–900.
- Nash, J.E., Sutcliffe, J.V., 1970. River flow forecasting through conceptual models part I — a discussion of principles. *Journal of Hydrology* 10, 282–290. [https://doi.org/10.1016/0022-1694\(70\)90255-6](https://doi.org/10.1016/0022-1694(70)90255-6)
- Neitsch, S., Arnold, J., Kinry, J.R., Williams, J.R., 2011. Soil and Water Assessment Tool Theoretical Documentation. Version 2009. Texas Water Resources Institute Technical Report No. 406. 618pp.
- Rathjens, H., Bieger, K., Chaubey, I., Arnold, J.G., Allen, P.M., Srinivasan, R., Bosch, D.D., Volk, M., 2016. Delineating floodplain and upland areas for hydrologic models: a comparison of methods. *Hydrological Processes* 30, 4367–4383.
- Sechu, G.L., Nilsson, B., Iversen, B.V., Greve, M.B., Børgesen, C.D., Greve, M.H., 2021. A Stepwise GIS Approach for the Delineation of River Valley Bottom within Drainage Basins Using a Cost Distance Accumulation Analysis. *Water* 2021, 13, 827.
- Thodsen, H., Andersen, H.E., Blicher-Mathiesen, G., Trolle, D., 2015. The combined effects of fertilizer reduction on high risk areas and increased fertilization on low risk areas, investigated using the SWAT model for a Danish catchment. *Acta Agriculturae Scandinavica, Section B — Soil & Plant Science* 65, 217–227.

Spildevandsscenerier (AP 2.6 – anden del)

Odense Fjord Kystvandråd - WWTP scenarios

Resume og konklusioner

Over de sidste 15 år har VandCenter Syd gjort det til en hovedprioritet at begrænse de negative miljøeffekter af udledning og emissioner fra vores renseanlæg. I dag ligger de gennemsnitlige, årlige koncentrationer af organisk stof og næringsstoffer væsentligt under kravene i udledningstilladelsen. Rensegrader i størrelsesordenen 90-98% er typiske, hvilket er resultatet af en langsigtet optimeringsindsats med brug af realtidsovervågning og dynamisk styring af renseanlæggene.

Analyser fra Syddansk Universitet, SEGES og DHI viser dog et potentiale for at begrænse opportunistisk algevækst i det tidlige forår som følge af yderligere reduktioner af næringsstoffer i det rensede spildevand.

Disse er mulige at opnå, men omkostningstunge og til en vis grad uden for de juridiske og økonomiske ramme for forsyningsvirksomheder i Danmark. Ikke desto mindre kan forbedringer i skalaen på 0-10 % opnås i den tidlige vækstsæson. Reduktioner i denne skala introduceres i scenarie 2, hvor DHI har modelleret effekten af en ca. 10% reduktion fra de tidligere nævnte 3,32 mg/l til 3,0 mg/l TN og 0,22 mg/l til 0,2 mg /l TP.

Miljøpåvirkningerne, næringsstoffereduktionerne medfører, bør tages i betragtning, når man overvejer muligheden for reduktioner. Disse gælder øget kemikalieforbrug, øgede drivhusgasudledning og suboptimal energiproduktion.

At reducere den indgående belastning ved at sortere vandet ved kilden er en anden metode til at begrænse udledning af næringsstoffer. Volumen af tilledt spildevand til renseanlæggene er ca. tre gange højere end den vandmængde, der betales for. Der eksisterer ydermere en negativ sammenhæng mellem rensegraden og det tilledte volumen på grund af den belastning, som uvedkommende vand påfører de biologiske renseprocesser. Ved at minimere belastningen fra denne fraktion, ville udløbsvolumenet ydermere falde, hvilket sammen med en mere effektiv retsproces vil resultere i reduktioner i massen af næringsstoffer.

Introduction

In relation to the implementation of the EU Water Framework Directive in Denmark, the Danish Environmental Ministry has selected 5 local coastal water committees – one concerns the Odense Fjord Catchment. VandCenter Syd (VCS) is a part of this interdisciplinary committee and represents water companies within the catchment area.

This document presents VCS' documentation for the wastewater treatment plant (WWTP) scenarios run in the Mike3 model of Odense Fjord. VCS has delivered data to SEGES, who has done initial

analysis and forwarded relevant time series to DHI. VCS has approved the scenarios conducted by DHI.

Please note, that a SWAT analysis was conducted by Aarhus University as well. Documentation for the wastewater scenarios is presented in the material prepared by Aarhus University and is not included in this document.

Resume and conclusions

Over a course of 15 years, VCS Denmark has made it a main priority to limit the adverse environmental effects of discharge and emissions from our WWTPs. Today, the average annual concentrations of effluent organic matter and nutrients are significantly below the requirements set out in the discharge permit. Reductions in the order of 90-98% are typical, illustrating our efforts in optimizing through real time monitoring and dynamic control of the wastewater treatment plants.

Nevertheless, the analysis from the University of Southern Denmark, SEGES and DHI demonstrate a potential to limit opportunistic algae growth in the early spring as a consequence of a further reduction of nutrients in the effluent from the WWTPs.

Further reductions at the treatment plant level are possible but costly and to some extent currently outside the legal framework of utilities in Denmark. Nevertheless, improvements can be achieved in the scale of 0-10% reductions in the early growth season. This is introduced in scenario 2, in which DHI has modelled the effect of an approximate 10% reduction from the earlier mentioned 3,32 mg/l to 3,0 mg/l TN and 0,22 mg/l to 0,2 mg/l TP.

To achieve a 0-10% reduction, that the environmental impacts in the form of increased chemical consumption, increased GHG emissions and suboptimal energy production will need to be taken into account when considering the option of onsite reductions in nutrient load.

Reducing the incoming load by sorting the water at the source is another worthwhile method to mitigate nutrient discharge. Incoming flow volumes to the treatment plants are approximately three times higher than the amount of water accounted for. A negative correlation exists between the purification degree and incoming flow, due to the stress that extraneous water puts on the biological treatment processes. Lower discharge volumes would follow from minimizing the load of this fraction resulting in overall reductions in the mass of nutrients.

Current wastewater treatment in the catchment and the challenges

Over the years VCS Denmark has made it a main priority to limit the adverse environmental effects of discharge from our WWTPs. This has resulted in internal performance targets allowing for advanced optimizations of the treatment process. Today discharge of organic matter and nutrients are significantly below the requirements set out in the discharge permit as seen in figure 1, 2, and 3. Reductions in the order of 90-98% are typical, illustrating that the potential for purification improvements is limited.

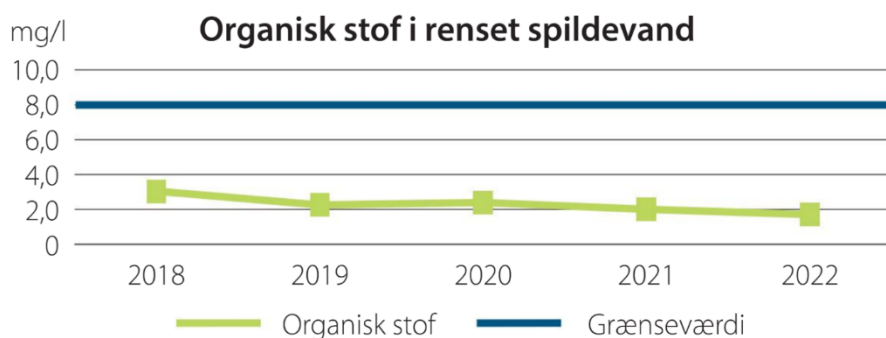

Figure 47 shows

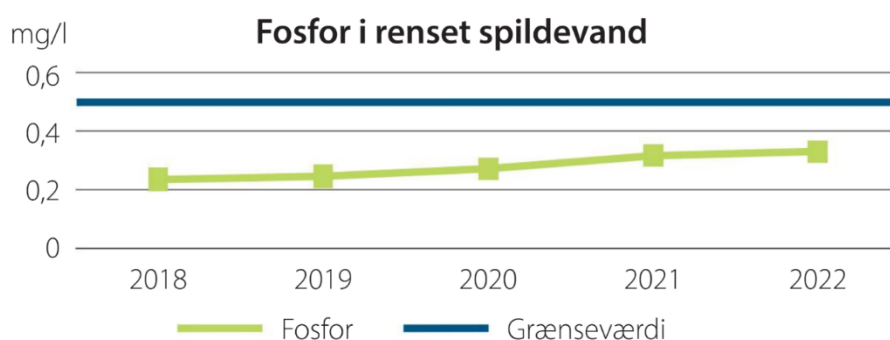
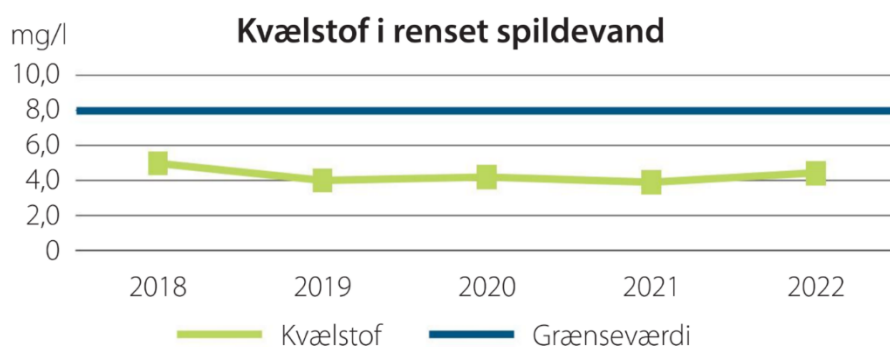

Figure 45 shows average total phosphorous concentrations in discharge across the eight WWTPs.



The shown increase in TP concentrations is a result of a relative decrease in the dosage of precipitation chemicals. The decision to allow for higher concentrations, which are still well below the legal limit,

Figure 3 shows average total nitrogen concentrations in discharge across the eight WWTPs.

is made with consideration to the energy balance and economic savings.

Table 4 shows the average concentrations of total nitrogen and total phosphorous as calculated by DHI based on 2013-2023 data from VCS. Summer is defined as April 1st to September 30th.

[mg/l]	TN		TP	
WWTP	Annual	Summer	Annual	Summer
EM (80%)	4,31	3,40	0,23	0,21
NV (10%)	3,27	2,50	0,26	0,31
NØ (10%)	4,48	3,57	0,23	0,23

Based on effluent concentrations monitored over the past ten years at the three biggest WWTP owned by VCS, DHI has calculated the averages shown in table 1. When a weighted average between the plants is calculated, based on the shown percentages, a summer concentration of 3,32 mg/l TN and 0,22 mg/l TP is found.

All eight facilities are operationally optimized with the use of digital automation tools as well as online monitoring. This ensures the best possible cleaning under the widely varying conditions. These include seasonal and weather dependent changes in temperature, flow, and composition of the incoming wastewater. The distinctly dynamic conditions pose great demands for control and real time optimization at the WWTP level. Despite these optimizations, biological plants are naturally challenged when the temperature is low, and the incoming flow is significantly increased as can be seen from figure 4 and 5.

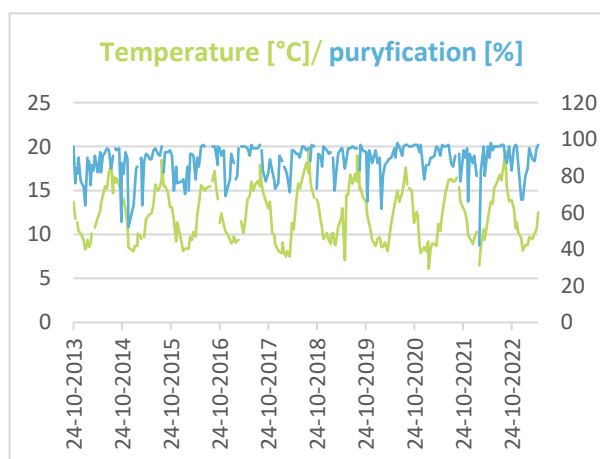
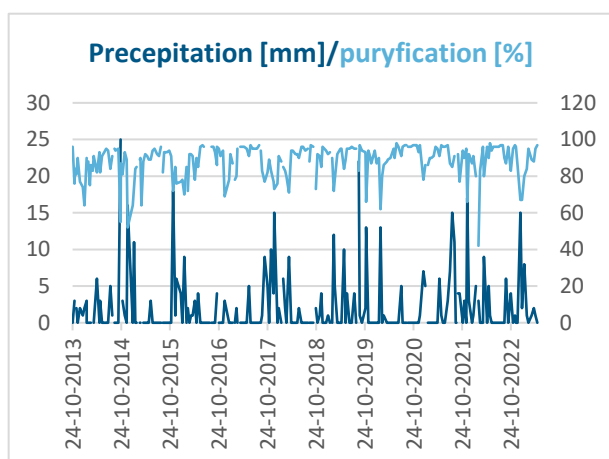

Figure 4 (left) shows the correlation between precipitation and the degree of purification achieved calculated based on discharge levels of total nitrogen at Ejby Mølle WWTP.

Figure 5 (right) shows the correlation between temperature variation and the degree of purification achieved calculated based on discharge levels of total nitrogen at Ejby Mølle WWTP.

Scenario 2: WWTP nutrient reductions

Further reductions at the treatment plant level are possible but costly and to some extent currently outside the legal framework of utilities in Denmark. Nevertheless, improvements can be achieved in the scale of 0-10% reductions in the early growth season, where WWTP discharge has the biggest relative impact on the fjord system. This is clear from scenario 2, in which DHI has modelled the effect of an approximate 10% reduction from the earlier mentioned 3,32 mg/l to 3,0 mg/l TN and 0,22 mg/l to 0,2 mg/l TP, during the growth season defined as April through September.

To reduce phosphorus in the effluent in line with these targets will take a significant increase of the precipitation chemical dosage. A higher consumption of these metal salts poses associated negative environmental side effects and a noteworthy price increase.

Regarding nitrogen higher degrees of average purification will necessitate adding molasses as carbon enrichment of the denitrification step under wet weather conditions. This will help the biological conversion to nitrogen gas within the limitations that at any given time 1-2 mg/l of TN remains nonbiodegradable. Dosing carbon will lead to a worse energy balance and increased greenhouse gas (GHG) emissions as added molasses is converted to carbon dioxide. In addition, it will increase treatment costs.

Among other options is the use of membrane technology for filtration of the effluent. Membrane filtration is very expensive in terms of both establishment costs and operating costs. This is due to the amount of chemicals applied in operation and maintenance of the technology coupled with a substantial energy consumption. Plants with membranes typically leave a residual stream in the form of brine consisting of 20-50% of the flow. This brine stream is a concentrate of the substances found in the treated wastewater. Some of the nutrients can be reduced in subsequent advanced biological/chemical purification, but other substances such as salts will pose a treatment problem.

At VCS' main facility Ejby Mølle WWTP, extensive consideration has been given to the production of green energy. At the same time there has been a focus on reducing GHG emissions in the form of nitrous oxide and methane. These measures have been carried out while respecting the internal goals regarding the discharge quality. Space restrictions at the centrally located Ejby Mølle WWTP further limits the implementation of additional treatment technologies. Alternatively large parts of the plant will have to be moved, which is a financially unsound causing a major price increase for the consumers.

In conclusion, it must be stated that the environmental impacts in the form of increased chemical consumption, increased GHG emissions and suboptimal energy production will need to be taken into account when considering the option of onsite reductions in nutrient load.

Reducing the inflow to the WWTP - Sorting water at the source

Even if a higher purification degree can be achieved through the abovementioned measures, ultimately the question of mass nutrient load is at stake. As seen in figure 4 there exists a negative correlation between precipitation and purification degree. If this relationship is to be mitigated reducing the incoming load by sorting the water at the source may be a worthwhile effort. With a

lower incoming load lower discharge volumes would follow as well resulting in overall reductions to the mass of nutrients.

The amount of extraneous water that VCS' WWTPs receive stresses the treatment process. With regards to the biological treatment processes the fraction is challenging, firstly because the carbon to nitrogen ratio in the extraneous water is suboptimal compared to wastewater impairing the denitrification process and secondly due to the changing flows and relatively low temperature which decreases treatment efficiency as previously shown.

Despite attempts to remove rainwater from the wastewater sewer systems, the incoming flow to the treatment plants is approximately three times higher than the amount of water accounted for. In a 2019 study EnviDan mapped the origin of extraneous water to VCS' sewer system. From figure 6 it

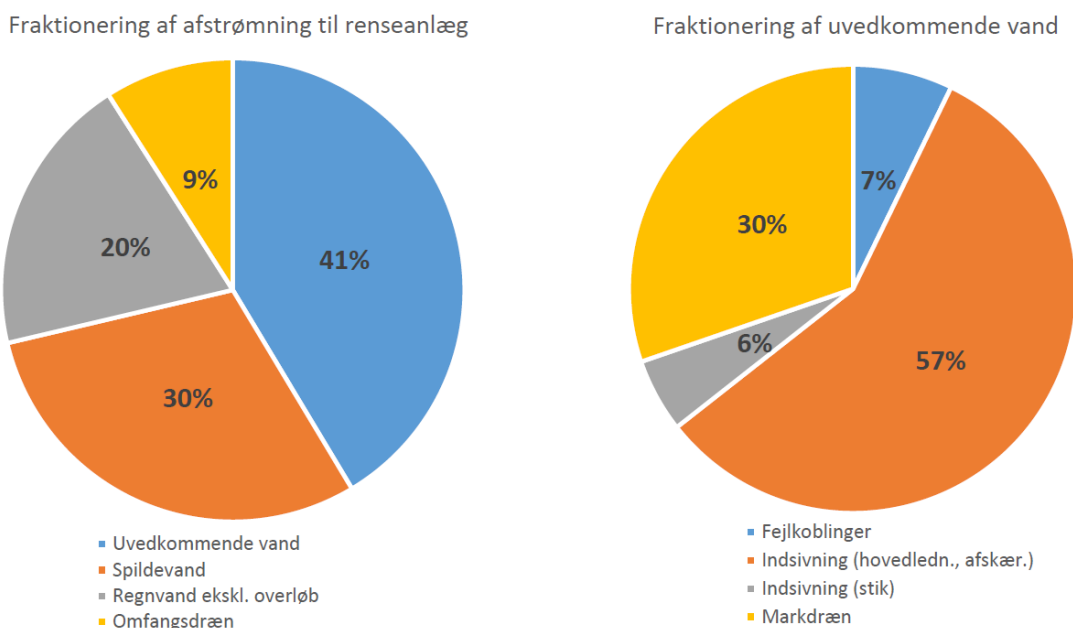

Figur 6
fractionation of the extraneous water (right) (Jensen et al., 2018).

a further

becomes clear that rainwater comprises a smaller fraction than intruding groundwater. For the past 15 years increased sealing of the sewer system has had limited momentum due to legal and political barriers. One such barrier being the possible local flooding in urban areas as a result of the existing 'drainage' being cut off.

With the national climate adaptation plan 1 published on October 23rd, 2023, the Danish government has stated that legislation which allows for collective solutions to so called 'high level groundwater' will be proposed in 2024. So far, the focus in the plan is mainly on the adverse effects, which the groundwater levels pose to human infrastructure. Considering the potential alleviation of incoming extraneous water to the WWTPs which the possibility for drainage combined with better sealed sewers allows, this legislation might as well play a part in stabilizing operation, which in turn will decrease the nutrient load to the receiving water bodies.

When considering how to progress in bringing down the incoming load to WWTPs, it is also worth keeping in mind that the nutrient load which is directed away from the treatment plant will need decentralized treatment. The University of Southern Denmark conducted a study in 2022 – a MIKE3

modelling effort carried out by Mikkel Lees and colleagues (Lees et al., 2022). When simulating a limited decentralized treatment with separate sewer discharge concentrations of 1,5 mg/l TN and 0,3 mg/l TP the total nutrient load to Vejle inner fjord across the main contributors showed a total P load from separated discharge on par with the load from the wastewater treatment plant and for total N the load for separate sewers were more than three times the amount from combined sewer overflows (CSO).

Table 5 shows the nutrient load from different sources to Vejle inner fjord. Table is adapted from Lees et al., 2022.

System	Source	TN [ton]	TP[ton]	% of Mike TN	% of Mike TP
Vejle river	Agriculture	413,0	16,3	73	52
	WWTP	61,9	3,8	11	12
	Separate sewer	19,2	2,8	3	12
	CSO	5,7	0,9	1	3
	Fish farming	63,0	6,5	11	21

Urban expansion of Odense is expected to double its size by 2045, however this is primarily in the form housing and non-water intensive industries. This tendency can be seen in the volume of incoming wastewater to the WWPT Ejby Mølle, where we have seen a stagnation of incoming water over the last 9 years.

On the other hand, the amount of extraneous water will further be exacerbated by the foreseen future changes in precipitation patterns and rising sea levels. Wetter winters with high standing ground water and frequent floods and cloudbursts will challenge the urban sewer system and treatment plants, which are not dimensioned for these compound weather events. This development makes for an even more compelling case to remove extraneous water from the sewer system to reduce the effluent of nutrients to Odense Fjord.

Other initiatives to reduce nutrient effluent.

Besides optimizing the WWTP there are some other VandCenter Syd initiatives, which can be said to bring reductions in nutrient discharge to Odense Fjord. VCS' ground water protection schemes are a noteworthy mention. Currently VCS is working towards realizing the Holmehaven project in partnership with Assens Municipality and HedeDanmark A/S. The project aims at afforestation and wetland creation on a 500 ha large area and has been estimated to alleviate the fjord of 20 tons of nitrogen annually from 2026.

Bibliografi:

Lees, M. K., Flindt, M. R., Canal-Vergés, P. 2022. Modelaktivitet i projekt Sund Vejle Fjord. SDU Biologi- rapport. Biologisk Institut, Syddansk Universitet. 16 pp.

Jensen, D., G., Jeppesen, J., Vollertsen, E., Rasmussen, S., H. 2018. Uvedkommende Vand og Vandoperatørrollen. EnviDan. 51 pp.

Scenarier for reduktion af den diffuse fosfortilførsel

Scenarios for reducing diffuse phosphorus. Technical note.

Author: Flemming Gertz SEGES Innovation

This technical note is based on work from Aarhus University to Kystvandråd Odense Fjord. A report from Aarhus University will be published and citations should be made to that report:

Andersen, H.E. 2023. Muligheder for reduktion af den diffuse fosfortilførsel til Odense Fjord. Aarhus Universitet, DCE – Nationalt Center for Miljø og Energi, xx s. - Teknisk rapport nr. xxx

Introduction

Odense Fjords' vulnerability to nutrients has been discussed in the technical group within the Kystvandråd Odense Fjord including, SDU, DHI, and SEGES. Based on that it was decided to find reductions in the catchment for both nitrogen and phosphorous to attain good ecological status in the fjord. Hereafter Aarhus University was involved in the work of making scenarios for reducing diffuse phosphorous.

Diffuse phosphorous

The project focuses on providing options for reducing diffuse phosphorus loss from risk areas in the catchment area of Odense Fjord by combining detailed mapping of phosphorus loss with different mitigation measures. Phosphorus loss primarily originates from five diffuse sources: erosion, leaching, macropore loss, loss from cultivated organic soil, and bank erosion. The mapping shows that these sources account for 94% of the total diffuse phosphorus loss at a national level.

The total phosphorus input to Odense Fjord averages 45.1 tons P over the period 2012-2021, of which the diffuse contribution is 26 tons P. The most significant diffuse loss pathways for phosphorus are bank erosion and loss via macropore to tile drains, which account for 39% and 26% of the total diffuse input, respectively.

Diffuse phosphorous reduction scenarios

The project first calculates the effect of different measures when the potentials are fully utilized.

Different measures such as afforestation, riparian zones, trees on riverbanks, sand traps, minor reach-based restorations, re-meandering of watercourses, mini-wetlands, integrated buffer zones, GLM 5, and phosphorus wetlands were suggested, and the full potential was calculated. For further information on this see the full report from AU.

Next, all possible measures were discussed at several meetings and a workshop with “kystvandråd” and others. Based on a prioritization in the Kystvandråd the following scenarios were selected:

- Phosphorus wetlands
- Tree planting on riverbanks
- Mini-wetlands

Phosphorus wetlands

It is assumed that 10% of the wetlands in the local scenario are established as actual phosphorus wetlands. This means wetlands are designed in such a way that the watercourse is allowed to periodically flood the watercourse's adjacent areas, thereby depositing sediment-bound phosphorus. Calculating the effect requires local information on the minimum size of the flooded area and the duration of the flooding. To calculate the effect, several assumptions have been made:

Based on a survey of the amount of suspended matter in Danish watercourses (Thodsen et al., 2019), a phosphorus sedimentation rate of 1.0 kg P ha⁻¹ day⁻¹ is assumed for flooding. According to Hoffmann et al. (2020), the size of the flooded watercourse adjacent area is assumed to be 25 m, 75 m, and 100 m on each side of small, medium-sized, and large watercourses, respectively. However, based on empirical studies, these widths must be reduced by 25% because there may be high-lying areas near the watercourse that are not flooded (B. Kronvang, pers. komm.). The duration of flooding is set to 15 days, which is a conservative estimate relative to Hoffmann et al. (2020).

The length of the watercourse within the wetlands is found by an overlap analysis in GIS. The width of the watercourses has already been mapped. Phosphorus retention by deposition during flooding is first calculated for all wetlands. The final effect is then found as 10% of the total effect, as it is not known which wetlands will be established as phosphorus wetlands.

Tree planting on riverbanks

A scenario has been set up with the placement of wetlands along a part of the watercourses in the Odense Fjord catchment area. There is no desire to plant trees along the watercourses within the wetlands. In addition, large watercourses (type 3, width greater than 10 m) are to be kept free of tree planting. Therefore, the scenario with wetlands and tree planting includes tree planting on the small (type 1, width less than 2 m) and medium-sized watercourses (type 2, width 2 - 10 m) outside the wetlands. Tree planting is assumed to take place on 10% of these watercourses, where the areas with the greatest brink erosion are prioritized.

Mini-wetlands

Based on work from SEGES (see other cap. On mini-wetlands) a potential of 127 mini-wetlands are planned with a total catchment area for the mini-wetlands of 10761 ha (Figure 1). Based on the calculations of the effect of the maximum potential for mini-wetlands (section 3.7), an average effect per area unit is calculated by dividing the effect at full utilization of the potential by the area of the full potential. The area effect is then multiplied by the catchment area of the 127 planned mini-wetlands.

Results from local prioritized scenarios

- Effects from 10% of the planned wetlands are created as phosphorus wetlands with periodic flooding: 5,4 tons P / year.
- Effects from tree planting along 10% of small and medium-sized streams outside wetlands: 0,6 ton P / year
- Effects from 127 mini-wetlands: 0.5 tons of P / year.

Total effects of the prioritized measures to reduce phosphorous: 6,5 ton P / year

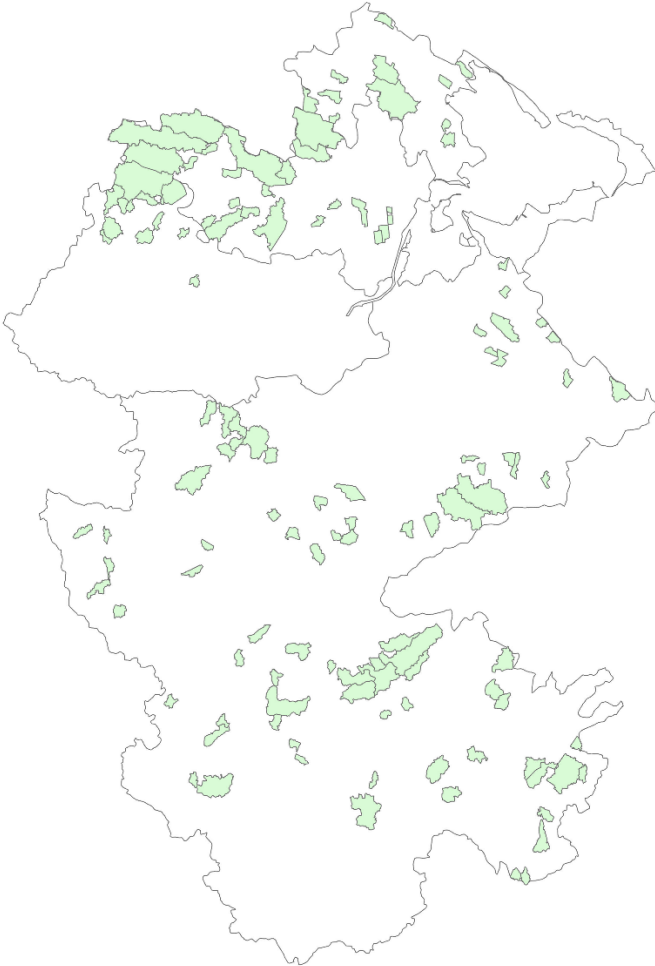

Figure 48. Catchments to 127 potential mini-wetlands.

Virkemiddelsplacering (AP 2.10)

Measures for reducing nutrients – ID15 lists.

Authors: Flemming Gertz SEGES Innovation

Introduction

This document includes 3 measures:

- Wetlands
- Mini-wetlands/constructed wetlands
- Trees along streams

The geographical placement has been done with 3 different tools combined with dialogs with catchment groups and the Kystvandråd. See specific chapters in the report for more information.

Concerning wetlands, the specific area is slightly overestimated in the below table. More precise numbers can be delivered if requested.

Table with wetland area in each ID15 and the percentage for each ID15. For scenario 1 (hrus2) and scenario 2 (VP3). The average of these 2 scenarios has been used as in the fjord model.

Id15_opland	Areal (ha)	SWAT_hrus2 (ha)	Andel hrus2 (%)	SWAT_VP3 (ha)	Andel VP3 (%)
42310001	1824,1	172,8	9	168,0	9,2
42310002	1708,3	168,5	10	156,6	9,2
42310003	2519,9	715,9	28	667,3	26,5
42310033	1093,6	108,5	10	104,2	9,5
42320001	1512,6	145,8	10	131,9	8,7
42320002	2389,5	576,5	24	566,5	23,7
42320003	2282,5	144,5	6	80,4	3,5
42320004	657,2	46,9	7	33,7	5,1
42320007	1396,1	272,3	20	222,5	15,9
42320016	2205,9	142,7	6	134,9	6,1
42320017	1794,5	259,5	14	252,9	14,1
42320018	1843,9	133,1	7	126,0	6,8
42320023	2155,0	152,6	7	140,2	6,5
42320026	1942,0	184,1	9	167,2	8,6
42320044	1266,4	176,9	14	165,3	13,1
42320053	161,3	2,8	2	2,8	1,7
42320119	2151,3	105,3	5	99,6	4,6
42320215	1820,6	129,9	7	122,5	6,7
42320221	1425,8	232,9	16	223,6	15,7
42320511	2827,7	210,7	7	174,3	6,2
42320648	2660,3	105,9	4	97,5	3,7
42320683	2871,1	51,2	2	50,7	1,8
42320687	2452,8	115,4	5	99,3	4,0
42320708	510,9	26,5	5	8,5	1,7
42320715	2392,2	135,7	6	107,6	4,5
42320718	1458,8	167,6	11	131,6	9,0
42320719	1139,9	37,3	3	33,2	2,9
42320720	1729,6	99,3	6	96,0	5,6
42320721	1864,0	183,4	10	146,5	7,9
42320722	3032,7	245,2	8	217,2	7,2
42320723	2327,9	247,3	11	235,1	10,1
42320724	145,8	9,8	7	3,7	2,6
42320729	1455,2	103,5	7	98,0	6,7
42320744	2648,7	246,7	9	230,8	8,7
42320755	1920,1	170,0	9	142,6	7,4
42320761	2132,8	154,9	7	144,6	6,8
42320762	2714,6	184,6	7	156,7	5,8
42320765	2632,5	90,7	3	68,3	2,6
42320766	3080,1	238,9	8	230,2	7,5
42320788	1648,9	85,9	5	79,0	4,8
42320794	1965,9	183,6	9	178,4	9,1
42320799	2049,1	216,5	11	177,2	8,6
42320823	1493,1	156,9	11	139,8	9,4
42320824	38,1	1,1	3	1,1	2,8
42320825	336,8	12,0	4	11,3	3,3
42320830	1142,0	108,9	10	55,0	4,8
42320831	412,3	32,7	8	31,4	7,6
42320832	170,4	2,5	1	1,5	0,9
42320834	163,1	4,3	3	4,2	2,6
42320835	185,0	1,0	1	1,0	0,5
42320836	350,9	15,1	4	12,0	3,4
42320837	135,4	1,4	1	0,5	0,3
42320919	340,7	0,0	0	0,0	0,0
42321010	48,0	0,2	0	0,2	0,4
42321174	1276,2	40,7	3	39,5	3,1
42321178	246,4	1,3	1	1,4	0,5
42321192	51,8	1,7	3	1,0	1,9
42321869	1180,3	49,9	4	45,6	3,9
42330001	2763,9	75,4	3	69,4	2,5
42330002	1542,8	27,0	2	26,9	1,7
42330018	1745,3	35,9	2	25,2	1,4
42330023	2433,3	185,3	8	174,9	7,2
42330444	2201,7	208,3	9	194,5	8,8
42330452	2361,4	136,4	6	101,4	4,3
42330456	2658,2	249,9	9	218,2	8,2
42330842	77,8	2,1	3	2,1	2,7
42330896	77,2	6,7	9	6,5	8,5
42330897	423,4	66,6	16	64,3	15,2

Table with mini-wetlands/constructed wetlands

Månedlig effekt af minivådområder summeret på ID15 niveau(kg N)														ID15 opl	antal minivådområder
D15 opland	januar	februar	marts	april	maj	juni	juli	august	september	oktober	november	december	hele året	(kg N)	(kg N)
42310002	65,03	48,82	43,60	18,44	6,28	2,15	3,57	3,82	10,92	31,55	58,36	60,42	352,87	42310002	2
42310003	607,01	456,57	406,96	172,14	58,64	20,08	33,34	33,82	101,93	294,46	544,76	563,95	3293,66	42310003	7
42310033	56,21	42,28	37,68	15,94	5,43	1,86	3,09	3,13	9,44	27,26	50,44	52,22	304,97	42310033	2
42320002	170,17	128,00	114,09	48,26	16,44	5,63	9,35	9,48	28,58	82,55	152,72	158,10	923,36	42320002	6
42320007	132,87	99,94	89,08	37,68	12,84	4,40	7,30	7,40	22,31	64,45	119,24	123,44	720,94	42320007	3
42320016	632,91	476,05	424,33	179,49	61,15	20,94	34,76	35,26	106,28	307,02	568,00	588,01	3434,21	42320016	5
42320017	460,12	346,08	308,48	130,49	44,45	15,22	25,27	25,64	77,27	223,20	412,93	427,48	2496,64	42320017	2
42320018	1188,70	894,09	796,95	337,10	114,84	39,32	65,29	66,23	199,61	576,63	1066,79	1104,38	6449,94	42320018	6
42320023	910,86	685,11	610,68	258,31	88,00	30,13	50,03	50,75	152,96	441,85	817,44	846,24	4942,36	42320023	8
42320026	50,71	38,14	34,00	14,38	4,90	1,68	2,79	2,83	8,52	24,60	45,51	47,11	275,14	42320026	2
42320044	73,97	55,63	49,59	20,98	7,15	2,45	4,06	4,12	12,42	35,88	66,38	68,72	401,34	42320044	3
42320119	196,75	147,99	131,91	55,80	19,01	6,51	10,81	10,96	33,04	95,44	176,57	182,80	1067,59	42320119	2
42320215	24,53	18,45	16,44	6,96	2,37	0,81	1,35	1,37	4,12	11,90	22,01	22,79	133,09	42320215	1
42320511	142,38	107,09	95,46	40,38	13,76	4,71	7,82	7,93	23,91	69,07	127,78	132,28	772,58	42320511	4
42320648	177,37	133,41	118,92	50,30	17,14	5,87	9,74	9,88	29,79	86,04	159,18	164,79	962,44	42320648	4
42320683	227,73	171,29	152,68	64,58	22,00	7,53	12,51	12,69	38,24	110,47	204,37	211,57	1235,65	42320683	3
42320687	64,46	48,48	43,22	18,28	6,23	2,13	3,54	3,59	10,82	31,27	57,85	59,89	349,76	42320687	1
42320708	24,34	18,30	16,32	6,90	2,35	0,81	1,34	1,36	4,09	11,81	21,84	22,61	132,05	42320708	1
42320718	24,63	24,63	18,53	16,51	6,99	2,38	0,81	1,35	1,37	4,14	11,95	22,11	135,40	42320718	1
42320719	214,02	160,98	143,49	60,69	20,68	7,08	11,75	11,92	35,94	103,82	192,07	198,84	1161,27	42320719	4
42320720	48,86	36,75	32,75	13,85	4,72	1,62	2,68	2,72	8,20	23,70	43,84	45,39	265,09	42320720	2
42320721	316,29	237,90	212,05	89,70	30,56	10,46	17,37	17,62	53,11	153,43	283,85	293,85	1716,18	42320721	5
42320722	190,81	143,52	127,93	54,11	18,43	6,31	10,48	10,63	32,04	92,56	171,24	177,28	1035,35	42320722	2
42320723	319,11	240,02	213,94	90,49	30,83	10,56	17,53	17,78	53,59	154,80	286,38	296,47	1731,47	42320723	4
42320729	50,52	38,00	33,87	14,33	4,88	1,67	2,77	2,81	8,48	24,51	45,34	46,93	274,11	42320729	2
42320744	493,20	370,96	330,66	139,87	47,65	16,31	27,09	27,48	82,82	239,25	442,62	458,21	2676,12	42320744	5
42320755	179,09	134,70	120,07	50,79	17,30	5,92	9,84	9,98	30,07	86,87	160,72	166,38	971,74	42320755	2
42320761	176,72	132,82	118,48	50,12	17,07	5,85	9,71	9,85	29,68	85,73	158,60	164,19	958,90	42320761	5
42320762	144,52	108,70	96,89	40,98	13,96	4,78	7,94	8,05	24,27	70,11	129,70	134,27	784,18	42320762	3
42320765	108,77	81,82	72,93	30,85	10,51	3,60	5,97	6,06	18,27	52,77	97,62	101,06	590,22	42320765	3
42320766	24,72	18,59	16,57	7,01	2,39	0,82	1,36	1,38	4,15	11,99	22,18	22,97	134,13	42320766	1
42320788	96,29	72,43	64,56	27,31	9,30	3,19	5,29	5,37	16,17	46,71	86,42	89,46	522,49	42320788	3
42320794	17,81	13,40	11,94	5,05	1,72	0,59	0,98	0,99	2,99	8,64	15,99	16,55	96,65	42320794	1
42320799	29,69	22,33	19,91	8,42	2,87	0,98	1,63	1,65	4,99	14,40	26,65	27,59	161,12	42320799	1
42321762	502,92	378,27	337,17	142,62	48,59	16,64	27,62	28,02	84,45	243,96	451,34	467,24	2728,84	42321762	4
42321766	236,28	177,72	158,41	67,01	22,83	7,82	12,98	13,16	39,68	114,62	212,05	219,52	1282,09	42321766	4
42321869	101,75	76,53	68,22	28,85	9,83	3,37	5,59	5,67	17,09	49,36	91,31	94,53	552,08	42321869	1
42330452	71,63	53,87	48,02	20,31	6,92	2,37	3,93	3,99	12,03	34,75	64,28	66,55	388,65	42330452	2
42330456	805,83	606,11	540,26	228,52	77,85	26,66	44,26	44,90	135,32	390,90	723,18	748,66	4372,43	42330456	10
Total	9359,58	7045,97	6277,04	2663,79	908,83	311,16	513,54	521,46	1568,93	4532,47	8389,50	8694,82	50787,11	total	127

Table with threes along small and medium size streams

Type 1, bredde < 2 m			Type 2, bredde 2 - 10 m		
ID15 v. 2.4	meter vandløb med træer	Effekt, kg P pr. ID15	ID15 v. 2.4	meter vandløb med træer	Effekt, kg P pr. ID15
42310001	750	2	42310001	504	8
42320002	114	0	42310002	686	7
42320003	647	1	42310003	480	6
42320004	291	1	42310033	459	6
42320007	950	2	42320001	190	2
42320023	111	0	42320002	1934	28
42320053	206	0	42320003	484	7
42320221	149	0	42320004	459	11
42320511	501	1	42320007	123	1
42320648	143	0	42320016	738	7
42320655	1134	4	42320017	1243	15
42320683	336	1	42320018	228	5
42320687	131	0	42320023	345	5
42320708	430	1	42320044	1079	15
42320715	105	0	42320053	91	1
42320718	146	0	42320119	1707	23
42320720	203	0	42320511	547	6
42320721	300	1	42320648	661	7
42320729	346	0	42320655	1060	29
42320755	206	0	42320683	850	14
42320788	87	0	42320687	708	17
42320799	365	1	42320708	374	7
42320825	176	1	42320715	253	5
42320831	197	1	42320718	358	3
42320919	56	0	42320719	487	10
42321766	143	0	42320720	367	4
42330001	1809	4	42320721	174	2
42330118	117	0	42320722	437	5
42330456	93	0	42320723	200	2
42330842	30	0	42320744	306	5
Grand Total	10271	22	42320755	177	2
			42320761	244	2
			42320762	535	7
			42320765	1031	11
			42320766	756	7
			42320788	141	1
			42320794	332	4
			42320799	297	4
			42320823	101	1
			42320830	145	1
			42320831	199	3
			42320832	263	2
			42320834	79	2
			42321174	443	6
			42321762	257	2
			42321766	829	14
			42321869	280	2
			42330001	6536	123
			42330002	1915	52
			42330118	276	4
			42330452	1030	13
			42330456	363	5
			42330842	128	1
			Grand Total	33890	539

Finansieringskilder og omkostninger ved kollektive virkemidler (AP 3.1 og 3.3)

Wetland subsidy schemes and costs for wetland implementation

Authors: Flemming Gertz SEGES Innovation, Karsten Dollerup Møller SEGES Innovation

Resumé

Der findes i dag 5 forskellige ordninger med 100 % tilskud til etablering af vådområder. Hhv. Kvælstofvådområder, Fosforvådområder, Lavbundsprojekter, Klima-lavbundsprojekter og Minivådområder.

Målet om etablering af 6700 ha vådområdet i oplandet til Odense Fjord, som foreslået af Kystvandrådet, vil koste 637-833 Mio. kr., hvis man anvender standard middel referencetal for etablering af vådområder.

Introduction

Restoration of wetlands has been a part of Danish environmental protection since the implementation of the first water plan in 1987. During this period, an increased environmental awareness led to a prioritization of the protection and restoration of natural habitats, including wetlands. Environmental legislation, research on the ecological benefits of wetlands, and an increasing understanding of their role in nutrient cycle dynamics contributed to the initiation of restoration efforts.

Vandplan 1 was implemented in Denmark in 2009 and is also known as the Water Framework Directive (WFD) River Basin Management Plans for the first planning cycle. The plans are a part of the European Union's directive aimed at achieving good ecological and chemical status in water bodies, including rivers, lakes, coastal waters, and groundwater. Given the focus on achieving good ecological status in the waterbodies of Denmark, efforts related to wetland restoration only increased in the years following Vandplan 1. With the implementation of Vandområdeplanerne in 2021 funding options for several different wetland types have been expanded and currently, public funding is available for 5 different wetland types:

Kvælstofvådområder (Nitrogen wetlands)

Fosforvådområder (Phosphorus wetlands)

Lavbundsprojekter (Carbon-rich wetlands)

Klima-lavbundsprojekter: Climate-wetlands)

Minivådområder (Mini wetlands)

The subsidy schemes of all wetland types have been adjusted and updated regularly in line with an increased knowledge and experience with implementation, and with the arrival of new research. Klima-lavbundsprojekter are the most recent wetland subsidy scheme and funding is based exclusively on national funds. Klima-lavbundsprojekter are currently the most popular of the wetland subsidy schemes.

Kvælstofvådområder (N-wetlands)

The subsidy scheme for *N-wetlands* is administered by the Danish Agriculture Agency, while the Danish Environmental Protection Agency is responsible for the assessment of nature and environmental issues related to the applied projects. The subsidy scheme is co-financed by the EU and covers 100 percent of the expenses for both technical and property-related preliminary investigations, as well as the actual establishment of N-wetland projects.

Both Municipalities and the Danish Nature Agency can apply for funding for N-wetlands. Private landowners participating in projects are compensated for the economic losses that arise due to the extensification of agricultural operations.

Fosforvådområder (P-wetlands)

The subsidy scheme for *P-wetlands* is administered by the Danish Agriculture Agency, while the Danish Environmental Protection Agency is responsible for the assessment of nature and environmental issues related to the applied projects. The subsidy scheme is co-financed by the EU and covers 100 percent of the expenses for both technical and property-related preliminary investigations, as well as the actual establishment of lowland projects.

Both Municipalities and the Danish Nature Agency can apply for funding for P-wetlands. Private landowners participating in projects are compensated for the economic losses that arise due to the extensification of agricultural operations.

Lavbundsprojekter (Lowland wetlands)

Lavbundsprojekter are focused on restoration of the carbon-rich lowland soils with the aim of minimizing greenhouse gas emissions from agriculture. The subsidy scheme is administered by the Danish Agriculture Agency, while the Danish Environmental Protection Agency is responsible for the assessment of nature and environmental issues related to the applied projects.

The subsidy scheme is co-financed by the EU and covers 100 percent of the expenses for both technical and property-related preliminary investigations, as well as the actual establishment of lowland projects.

Both Municipalities and the Danish Nature Agency can apply for funding for lowland projects. Private landowners participating in projects are compensated for the economic losses that arise due to the extensification of agricultural operations.

Klima-lavbundsprojekter

Klima-lavbundsprojekter are focused on the restoration of the carbon-rich lowland soils with the aim of minimizing greenhouse gas emissions from agriculture. The subsidy scheme is managed by the Danish Environmental Protection Agency and is open to applications from municipalities, landowners, and foundations. In addition to CO₂-reduction, the scheme aims to support nature, water environment, and other climate-related objectives. Large projects with a high proportion of carbon-rich soil are given priority. This means that the subsidy scheme has a broad perspective and focuses

on synergy in the extraction of lowland soils. Synergy is directed towards the Water Framework Directive, Birds and Habitats Directives, biodiversity, protected natural types, clean drinking water, outdoor recreation, organic farming, and climate adaptation.

Mini wetlands (Constructed Wetlands)

The primary purpose of the *Mini wetland* subsidy scheme is to enhance water quality by reducing nitrogen loading from drainage water into the surrounding water environment. As a secondary effect, mini wetlands also retain phosphorus (P) from the drainage water. The subsidy scheme is administered by the Danish Agriculture Agency and is financed by the EU. Funding covers 100 percent of the expenses related to preliminary investigations, as well as the actual establishment. Funding is available to private landowners who want to establish a Mini wetland on their property, provided the project meets the requirements of the subsidy scheme.

Costs for establishing wetlands in the Catchment of Odene Fjord

The indicative average reference value for the establishment of N-wetland projects has been adjusted from DKK 1,300 per kg N to DKK 1,700 per kg N (https://edit.mst.dk/media/xieb2p13/vejledning_til_vand-og_klimaprojekter_2023.pdf)

Using the above values, the cost of removing 490 tons of nitrogen by implementing 6700 ha of wetland as suggested by the Kystvandråd will summarize to 637-833 Mio. DDK.

Omkostninger ved målrettede markvirkemidler (AP 3.4)

Economic consequences of nitrogen targets on the cultivation surface in the coastal water catchment area of Odense Fjord, Seden Strand

Economic analysis of 4 scenarios of nitrogen reduction efforts.

Producer:

SEGES Innovation P/S
Agro Food Park 15, Skejby
DK 8200 Aarhus N

Requester:

The analysis is requested by:
Kystvandråd Odense.

Authors:

Jacob Krog, SEGES Innovation P/S
Søren Kolind Hvid, SEGES Innovation P/S
Flemming Gertz, SEGES Innovation P/S

Contact:

Jacob Krog, SEGES Innovation P/S
D +45 6155 5783

Resume

Analysens formål er at vise omkostningerne ved at lave kvælstofreduktion på dyrkningsfladen. Helt grundlæggende er potentialet for kollektive virkemidler, vådområder og minivådområder, tilstrækkeligt stor til at yderligere indsats på dyrkningsfladen ikke er nødvendig. Men da der endnu er tale om et potentiale, og ikke reelt projekterede eller gennemførte projekter, er der lavet en række scenarier, der viser omkostningen ved at foretage en del af reduktionen på dyrkningsfladen. Basisscenariet fastlægges som en situation hvor der ikke er krav til målrettede efterafgrøder, og der laves 4 scenarier med varierende forhold mellem kollektiv indsats og indsats på dyrkningsfladen. Indsatsen målt i tons N pr. år er opgjort ved kysten, dvs. retentionen i landskabet er indregnet. Omkostninger til kvælstofreduktionsindsats på dyrkningsfladen stiger med indsatsen. Når der tages højde for årstidsvariation og dermed på reduktioner i perioden april-juli, er effekten af indsats på dyrkningsfladen forholdsvis begrænset. Omkostningen til kvælstofreduktion på dyrkningsfladen er dermed forholdsvis dyr. Den gennemsnitlige meromkostning, i forhold til en situation hvor der ikke er målrettet regulering, er 968 kr. pr. kg N reduceret på dyrkningsfladen i scenarie 1, hvor 88 pct. af potentialet for kollektive virkemidler etableres. Den gennemsnitlige meromkostning stiger til 3.148 kr. pr. kg N reduceret på

dyrkningsfladen i scenarie 4, hvor 68 pct. af kollektive virkemidler etableres. Til sammenligning kan omkostningen til vådområde beregnes til ca. 480 kr. pr. kg N reduceret i perioden april-juli.

Omkostningerne er beregnet med Virkemiddelvælgeren, der laver en økonomisk optimeret løsning af indsatskrav i kvælstofreguleringen på bedriftsniveau. Virkemiddelvælgeren er baseret på den nuværende reguleringsmodel, og er blevet tilpasset til at håndtere effekterne af efterafgrødevirkemidler og alternativer, når der tages højde for årstidsvariation.

Purpose and background

The purpose of the analysis is to show the costs of nitrogen reduction on the cultivation surface. Basically, the potential for collective instruments, wetlands and constructed wetlands, is sufficient, which means that further efforts on the cultivation surface are not necessary. However, as there is still a potential, and not actually planned or implemented projects, a number of scenarios have been made that show the cost of solving part of the reduction on the cultivation surface. The baseline scenario is defined as a situation where there are no requirements for targeted catch crops, and 4 scenarios are made with varying ratios between collective effort and effort on the cultivation surface. The effort measured in tones N per year is calculated at the coast, i.e. the retention in the landscape is factored in. The result shows, on the one hand, which instruments are to be used on the farms in the catchment area and, on the other hand, the cost for each individual farm meeting a given effort requirement. Calculation of costs for nitrogen effort on the cultivation surface is based on the algorithm of the Instrument Selector. For each farm, it is calculated which instruments are possible to apply to the cultivation surface in the form of catch crops, intermediate crops, early sowing, precision agriculture, reduction of standards and fallow. The instruments are allocated according to an economic optimization ensuring the cheapest solution proposed for each farm. The calculations are thus based on the normal crop selection and order of each holding at field level. The method for the calculations is described in Appendix 1 "Documentation for the Instrument Selector". For the calculation of effort requirements on the cultivation surface, the Instrument Selector has been adapted so that it can handle the changed relative effect of catch crops when seasonal variation is taken into account, and thus aims to cover the effort requirement in the period April-July. This is described in Appendix 2. "Adapting the Instrument Selector to handle seasonal variation".

Summary

Costs for nitrogen reduction efforts on the cultivation surface increase with the effort. When seasonal variation and reductions in the period April-July are taken into account, the effect of efforts on the cultivation surface is relatively limited. The cost of nitrogen reduction on the cultivation surface is thus relatively expensive. This can be seen in the average additional cost, compared to a situation where there is no targeted regulation, increases from DKK 968 to DKK 3,148 per kg N reduced on the cultivation surface from scenario 1 to scenario 4. In comparison, the cost of wetland can be calculated at approx. DKK 480 per kg N reduced in the period April-July.

Calculated per hectare in rotation, the additional cost is DKK 127 in scenario 1, while it reaches DKK 1,141 in scenario 4. In comparison, arable farms achieved an average profit after owner's salary of DKK 555 per hectare in the period 2011-2020. The costs to the farmer are calculated without taking into account support for targeted catch crops, as it shows the real cost. No decision has been made on how the cost of the cultivation surface can be divided between the farmer and the state. Instead of comparing each scenario with the baseline, the marginal cost between each scenario has been calculated on the far-right column of Table 1. The marginal cost shows the additional cost of moving from one scenario to another, for example, the marginal cost of increasing the effort from scenario 3 to scenario 4 of DKK 5,800 per kg N is reduced.

Table 1. Additional cost and marginal cost on the cultivation surface in 4 scenarios

	Tons N removed with collective efforts	Tons N removed per year on the cultivation surface	Additional cost, DKK/hectare	Additional cost DKK per kg N reduced on the cultivation surface	Marginal cost DKK per kg N reduced on the cultivation surface
Scenario 1	47,7	6,1	127	968	968
Scenario 2	45	8,8	280	1.475	2.623
Scenario 3	41	12,8	641	2.319	4.174
Scenario 4	37	16,8	1.141	3.148	5.800

Basis for scenarios in calculation for Odense Fjord

The starting point is Vandområdeplan 2021-27. The baseline for Odense Fjord, Seden Strand is 1182.5 tons N per year. The distributed effort requirement for Odense Fjord, Seden Strand is stated at 401.9 tons N, corresponding to 34%.

To account for the variation over the year in the best possible way, and not just implement a reduction in the winter period, the effort is divided into a summer period (April-July) and the rest of the year (August-March). DCE (2021) has estimated that approx. 15 per cent of the effect of the effect is found during the summer period (April-July). This results in a baseline load in the summer period of 177.4 tons of N. When this is reduced by 34%, there will be a distributed effort requirement for the summer period of 60.3 tons of N. The summer period is the part of the year where it is most difficult to make nitrogen reductions, therefore the annual emissions will actually be reduced by more than 401.9 tons of N.

It is expected that part of the effort on wastewater management can be delivered. However, it has only been calculated with 0.1 tons on an annual basis, corresponding to the extent specified in the river basin management plan. The wetlands in the local plan for Odense Fjord, Seden Strand, are calculated to have a total effect of 544 tons N on an annual basis. 50.3 tons are delivered between April and July. The constructed wetlands are estimated at 3.8 tons during the summer period and 37.7 tons as a sum over the whole year. In the calculation of the theoretical effect of the constructed wetlands, possible overlap with effects calculated in wetlands have not been taken into account. Therefore, reservations are made for any deviations as a result of this. The CAP (Common Agricultural Policy) without climate lowland soils, afforestation and extensification is set in the river basin management plan at 43.2 tons on an annual basis, corresponding to a summer effect of 6.5 tons. The effects from climate lowland, afforestation and extensification from the river basin management plan are expected to overlap with the proposals made for wetlands in the local action plan. Therefore, these expected impacts from the national river basin management plan have been omitted from this calculation. The above effects result in a total reduction of 60.7 tons of N in the period April-July. This exceeds the effort requirement by 0.4 tons of N, and thus no need to make an additional effort on the cultivation surface.

Table 2. Distribution of effort between summer and other parts of the year

Tons N	April-July
Share of annual effect	15%
Baseline	177,4
Distributed requirement	60,3
Wastewater	0,0
Wetlands	50,4
Constructed wetlands	3,8
CAP	6,5
Total reduction	60,7

If the full potential of wetland and mini-wetland is exploited, the total effect will be 54.2 tons of N in the period April-July. Since it is not a given that all locations can be established, a number of scenarios have been made that show the amount of effort needed to be handled on the cultivation surface if the collective effort is not fully implemented. This is shown in Table 3 and Figure 1.

Table 3. Scenarios for action on the cultivation surface.

		Basis	Scenario 1	Scenario 2	Scenario 3	Scenario 4
Share of collective instruments established	pct.	100	88	83	76	68
Wetland and constructed wetlands	Tons N	54,20	47,7	45,0	41,0	37,0
Residual for cultivation surface	Tons N	0	6,1	8,8	12,8	16,8
CAP	Tons N	6,5	6,5	6,5	6,5	6,5
Total reduction April-July	Tons N	60,7	60,3	60,3	60,3	60,3
Targeted catch crops	pct.	0	31	44	64	84

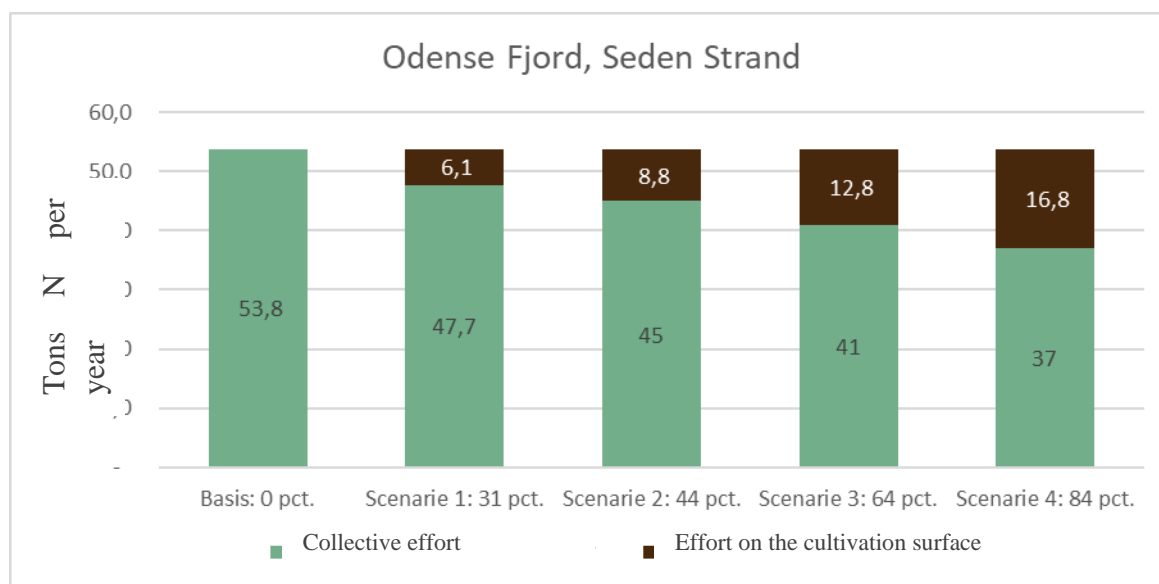

Figure 1. Distribution between collective effort and effort on the cultivation surface

Effect of catch crops

One hectare of catch crop on clay soil (destroyed in November) has an effect in April-July of 0.53 kg N per hectare. The basis for catch crop effect is given in Appendix 2. As an example, the reduction of 8.8 tons in scenario 2 requires an effort equivalent to 16,604 hectares of catch crops. In 2021, the catchment area of Odense Fjord, Seden Strand had a cultivated area of 57,014 ha and a catch crop plot area of 38,446 ha. It is assumed that the total potential for wetlands and constructed wetlands will cover 6,000 hectares in total.

If a total effect of 45 tons is to be achieved, as scenario 2 shows, it will occupy an area of approx. 5,000 ha, of which it is assumed that approx. one third (1,420 ha) is on the cultivation surface. The catch crop base area accounts for an average of 67 per cent of the rotational area in the catchment area. The catch crop base area is therefore reduced by 955 ha to 37,491 ha. When 16,604 hectares of catch crops are distributed over the catch crop base area, this corresponds to 44 per cent targeted catch crops. It is assumed that one third of the wetland's area is rotational land, while the remainder is outside the current rotational area. The calculation of land use for wetlands is estimated, and in order to address some of the uncertainty, a sensitivity analysis of the area use for wetlands has been made in relation to the effort requirement on the cultivation surface. If half of the wetland takes up rotational area instead of a third, the effort requirement calculated as a percentage of catch crops of the catch crop base area will increase by approx. 3 percentage points. Similarly, it is uncertain whether the share of the catch crop base area in the rotation area is also 67 per cent in the areas that are actually to be used for wetlands. However, it is an uncertainty that is of a manageable nature and does not change the conclusion.

Calculation at farm level

Consequences have been calculated for all farms throughout the catchment area. The solution appears as a combination of possible instruments on the cultivation surface for each individual farm. The potential calculation for instruments is based on each farm's crop distribution on all fields in 2018-2023. The common catch crop on clay soils is the unit used in the calculation. There is a difference in the effect of the instruments: Some instruments have a lower effect than catch crops and thus a larger area is needed to achieve the effect of 1 ha of catch crops, while other instruments are more effective than catch crops. The effort requirement measured in "per cent targeted catch crops" is a conversion from the effort requirement in the recipient to how many hectares of catch crops are needed to achieve the requirement and how much it constitutes of the available catch crop base area. Therefore, there is no automatic upper limit of 100 per cent. If the effort requirement in the recipient is high and the effect of catch crops low, then the effort requirement may exceed 100 per cent targeted catch crops. However, requirements above 100 per cent will lead to the need for set-aside as an essential part of the solution. For all 4 scenarios, the cheapest and regulatory accepted instruments are chosen to meet the requirement. It has been taken into account that some instruments overlap with others. For example, if you have catch crops on a farm where there is also a quota reduction, the effect of the quota reduction will be smaller.

Consequence of effort levels on the cultivation surface

In order to meet the effort requirement, a combination of different means is used on the cultivation surface. In Figure 2 below, the area with each instrument is sorted by increasing price for the four scenarios. Intermediate crops after seed grass and early sowing are the cheapest, while catch crops causing a change in crop rotation and fallow are the most expensive. The quota reduction stands for itself, as the price of the quota reduction varies with the application: The first 5 per cent reduction is significantly cheaper than a reduction from 15 to 20 per cent.

Distribution of instruments in various scenarios, coastal water Odense Fjord, Seden Strand

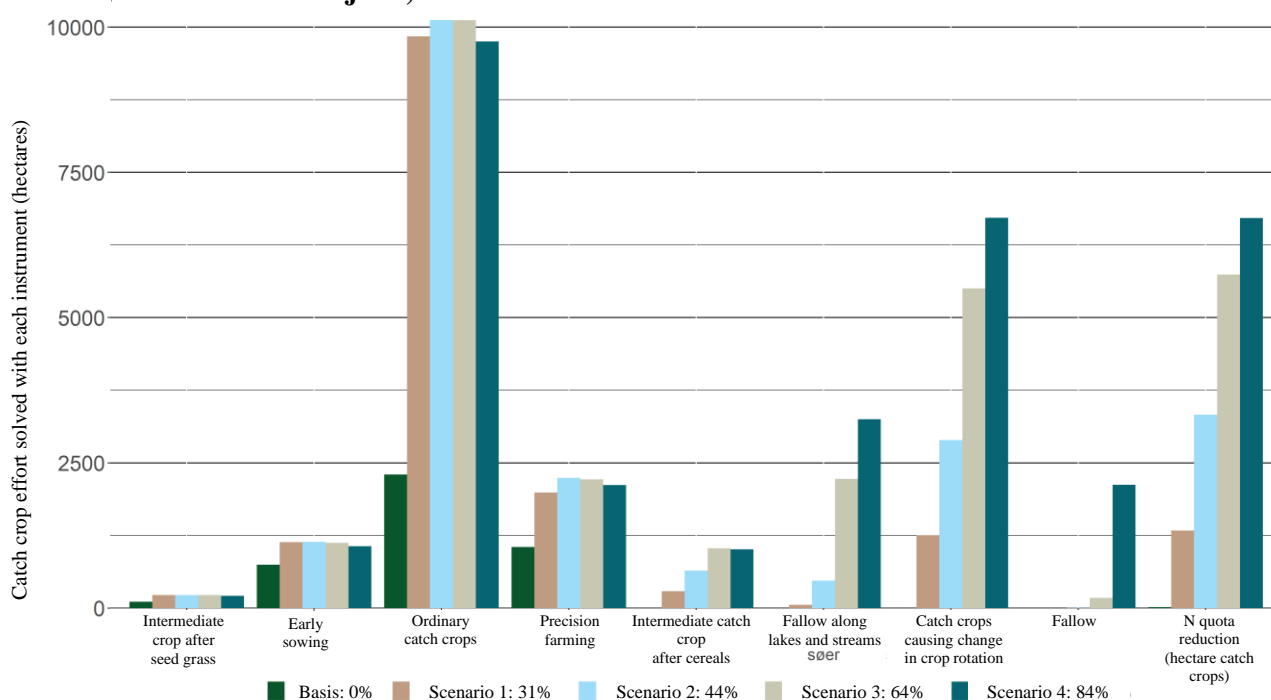

Figure 2: Distribution of instruments in the baseline scenario and the 4 scenarios.

Although the requirement for catch crops increases in the calculated scenarios, it is noteworthy that the area with ordinary catch crops only increases in real terms until scenario 2, when the effort requirement is 44% targeted catch crops. And the increase in common catch crops from scenario 1 to 2 is extremely limited because scenario 1 already occupies almost all the potential of common catch crops.

This is illustrated very clearly by the fact that the solution in scenario 2 includes an increase in more expensive instruments such as intermediate crop after cereals, fallow along lakes and streams, catch crops causing change in crop rotation and N quota reduction. The N quota reduction increases from covering 8% of the solution in scenario 1 to covering 16% in scenario 2.

The overall conclusion on the choice of instruments in scenario 2 is that an average effort requirement of 44% can be solved at DKK 280 per hectare in rotation. However, one third of the farms have additional costs compared to the starting point without targeted regulation of DKK 350-850 per hectare.

Scenarios 3 and 4 clearly show that only expensive instruments remain in the form of crop rotation changes, large N quota reductions and set-aside when the effort requirement reaches 64-84 per cent. These levels are both very intrusive in operations and extremely costly to implement as targeted regulation. Fallow in scenario 4 means that there is no longer room for the same amount of common catch crops.

The instruments vary greatly in price. The cheap instruments on the cultivation surface are even precision farming on farms that do not yet use it, which is priced at DKK 770 per hectare of catch crop requirements. Basically, the entire effort has been solved with cheap instruments on the cultivation surface, and the applied N quota reduction is at the cheap part. The share of the solution that is fulfilled with cheap instruments on the cultivation surface is reduced to 82% in scenario 1 and 65% in scenario 2, where ordinary catch crops only solve 48% of the total requirement. In scenarios 3 and 4, the low-cost instruments are reduced to 49% and 41% of the total solution, respectively.

Share of different catch crop instruments in the total solution, Odense Fjord, Seden Strand

Efterafgrødevirkemidlers andel af det samlede efterafgrødekrav, Odense Fjord, Seden

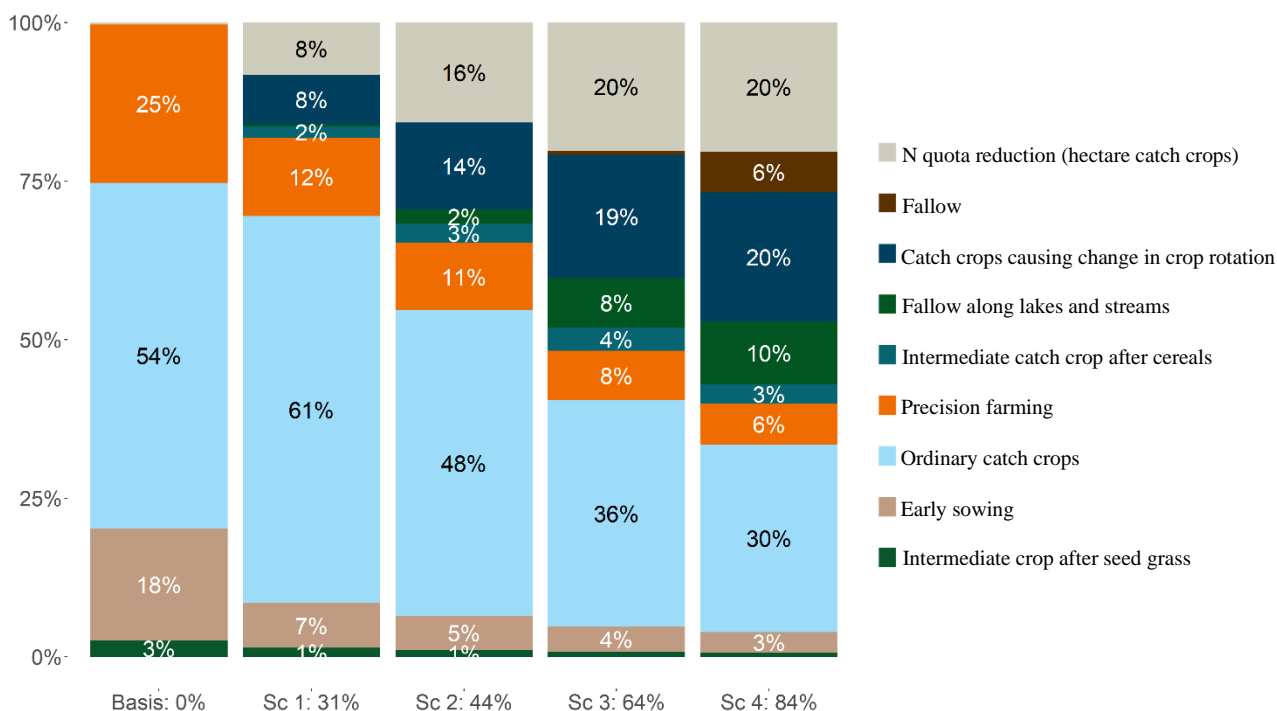

Figure 3. Share of different catch crop instruments in the total solution

Additional costs for different effort levels

When the effort requirement on the cultivation surface increases, the additional cost increases drastically (Table 4). In scenario 4, where 16.8 tons of N are to be found with effort on the cultivation surface, the total additional cost for the catchment area is DKK 53 million, which is DKK 1,141 per hectare. This additional cost has been calculated in relation to a situation without effort requirements on the cultivation surface.

Table 4: Additional costs compared to a situation without effort requirements on the cultivation surface.

	Collective efforts	Cultivation surface	Catch crops of catch crop base area	Additional cost compared to no requirement	Additional cost compared to no requirement	Additional cost compared to no requirement
	Tons N pr. year	Tons N pr. year	Pct.	tDKK	DKK/hectare	DKK/kg N
Scenario 1	47,7	6,1	31	5.903	127	968
Scenario 2	45	8,8	44	12.984	280	1.475
Scenario 3	41	12,8	64	29.681	641	2.319
Scenario 4	37	16,8	84	52.882	1.141	3.148

The development in the additional cost can also be seen in Figure 4, where a dotted line has been drawn between the calculated effort levels, indicated by percentages of catch crops of the catch crop base area. The dotted line shows how the additional costs compared to a situation without waging requirements develop for the average farm in the catchment area of Odense Fjord, Seden Strand.

When the targeted effort increases from 0 to 31 per cent, there is an additional cost of DKK 127 per hectare in rotation. The additional cost is up to DKK 280 for a targeted effort of 44 per cent and DKK 641 per hectare for 64 per cent. This is a very clear sign that the cheap instruments have been exhausted and

that increased efforts must be solved with instruments that are significantly more expensive than those already in use.

For comparison of the cost level, the average result after owner's salary for a crop farm in the period 2011-2020 is DKK 555 per hectare.

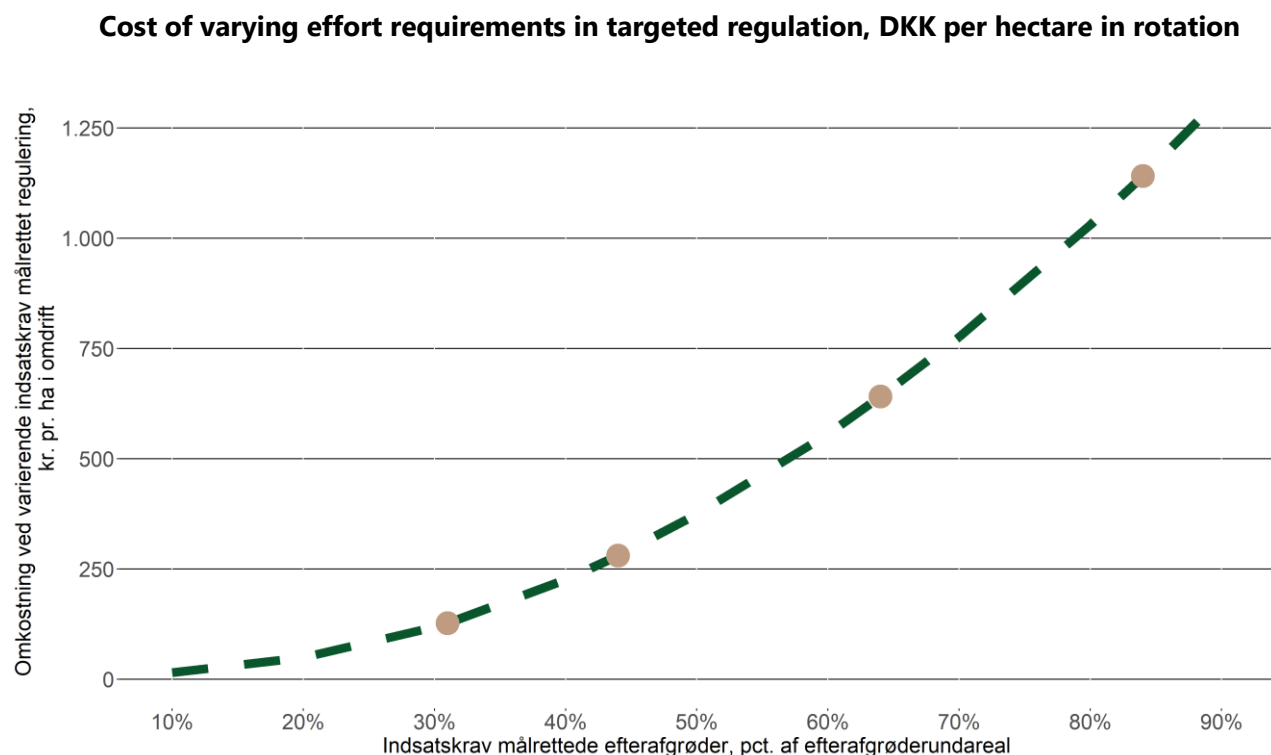

Figure 4. Cost of varying effort requirements in targeted regulation, DKK per hectare in rotation.

If the additional cost is not simply compared with the situation without effort requirements, but instead as the marginal change between scenarios, it becomes clear that an increased effort is made each time with even more expensive means.

	Marginal reduction, tons N per year	Marginal cost tDKK per year	Marginal cost DKK per kg N
Scenario 1 relative to basis	6,1	5.903	968
Scenario 2 relative to scenario 1	2,7	7.081	2.623
Scenario 3 relative to scenario 2	4	16.697	4.174
Scenario 4 relative to scenario 3	4	23.201	5.800

To put these marginal costs into perspective, the budget-economic price of a wetland on clay soil in the instrument catalogue (Eriksen et.al 2020) has been calculated at DKK 34 per kg N. This price is at a reduction of 190 kg N per ha, and with an expected effect of approx. 90 kg N per ha for wetlands in the catchment area of Odense Fjord, Seden Strand, an adjusted price will be DKK 72 per kg N reduced on an annual basis. If further correction is made for approx. 15% of the effect from the wetlands to be achieved

in the period April-July, cost of a wetland can be estimated at approx. DKK 480 per kg N reduced in the period April-July.

Overall, the calculations show that the regulation on the cultivation surface is significantly more expensive than collective efforts when a reduction is to be achieved in the period April-July.

Large difference in costs between farms

There is a wide variation in costs between farms. Figure 5 shows an overview of the additional costs for the 10 largest farms in the catchment area of Odense Fjord, Seden Strand. The brown part at the bottom shows each farm's additional cost of switching from current 0% targeted catch crops to 31% targeted catch crops. In the first scenario "31 pct.", a large difference in additional costs can be seen between farms. And the difference in economic consequences between farms is increasing, as can be seen with increasing effort requirements on the cultivation surface.

Additional costs per hectare, compared with a situation without targeted effort on the cultivation surface

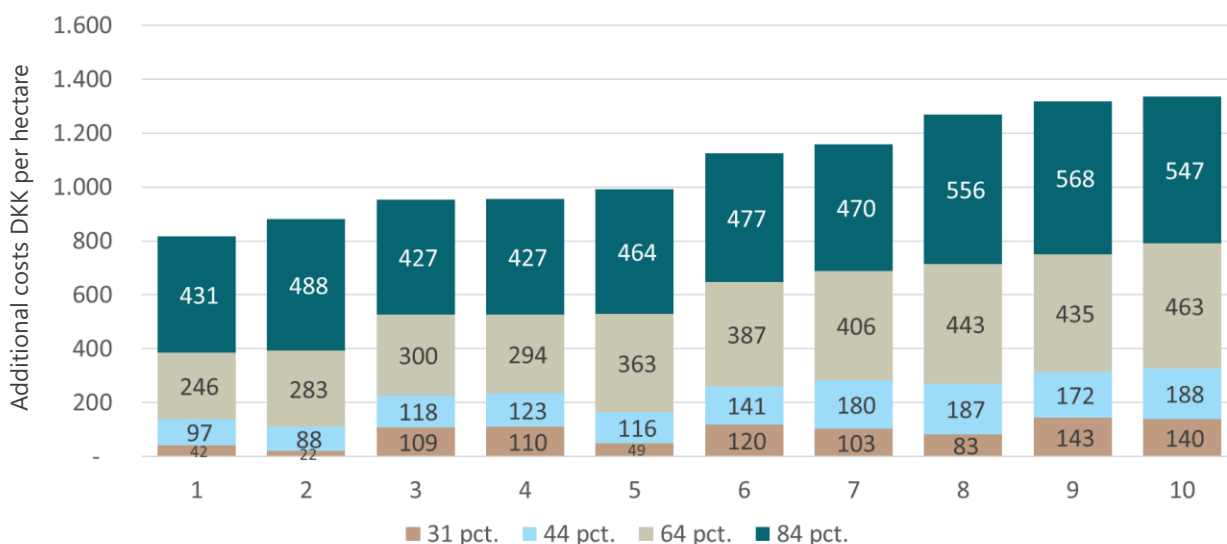

Figure 5. Spread in additional costs per hectare for the 10 largest farms in the catchment area

Differences in costs across catchment areas

Another way to show the difference in costs of regulation on the cultivation surface is the regional difference in the additional cost. Figure 6 shows how the additional cost is distributed between the different ID15 areas when 88% of the potential for collective efforts is established instead of full utilization, which would make further efforts on the cultivation surface superfluous. The calculation of costs at ID15 level is based on the calculated cost of each farm, which is allocated to all agricultural parcels of the holding. Next, an area-weighted average of the cost for each ID15 area is taken, as shown in the figure. Areas with less than 3 holdings as a data basis are white, as it has been assessed as an insufficient data basis.

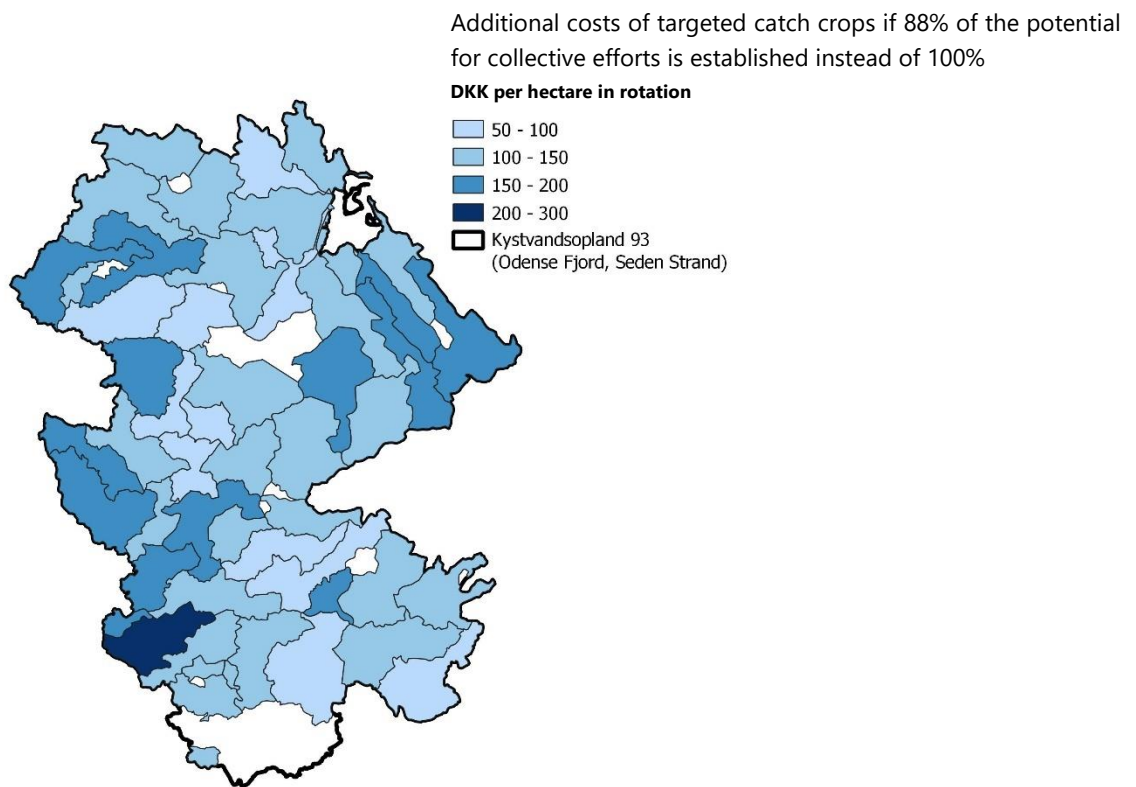

Figure 6. Additional costs if 88% of the potential for collective efforts is established instead of 100%

Figure 7 shows the additional cost if only 83% of the potential for collective efforts is implemented. In comparison with Figure 6, the map shows that the spread in additional costs increases when the effort requirement on the cultivation surface increases. And the same applies to Figure 8 and Figure 9, which respectively show 76% and 68% utilization of the potential for collective instruments in the catchment area of Odense Fjord, Seden Strand.

Additional costs of targeted catch crops if 83% of the potential for collective efforts is established instead of 100%

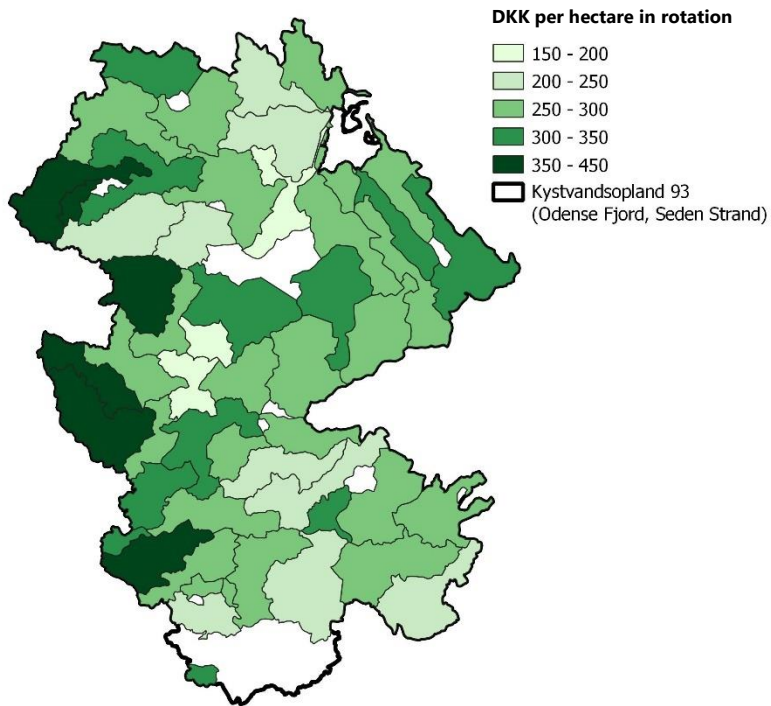

Figure 7. Additional costs if 83% of the potential for collective efforts is established instead of 100%

Additional costs of targeted catch crops if 76 % of the potential for collective efforts is established instead of 100%

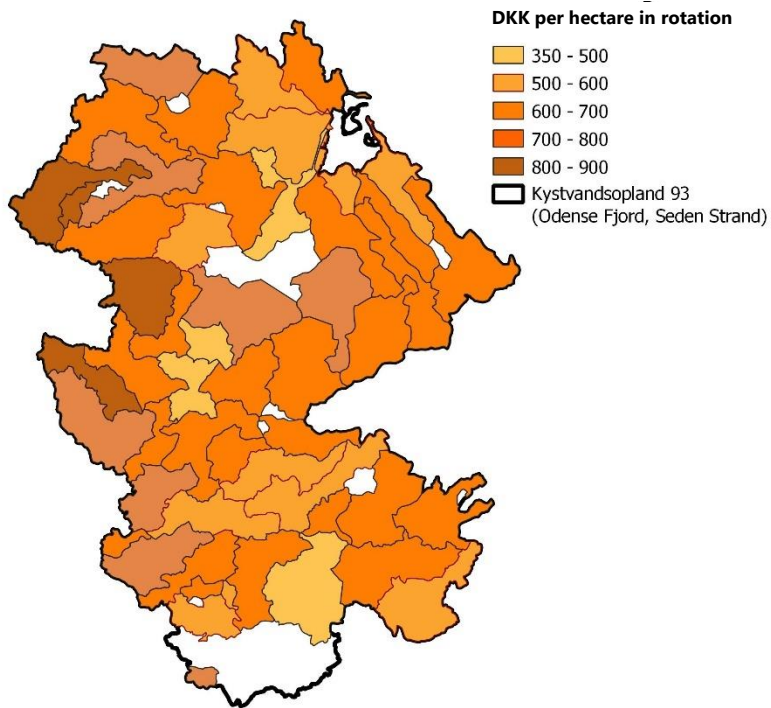

Figure 8. Additional costs if 76% of the potential for collective efforts is established instead of 100%

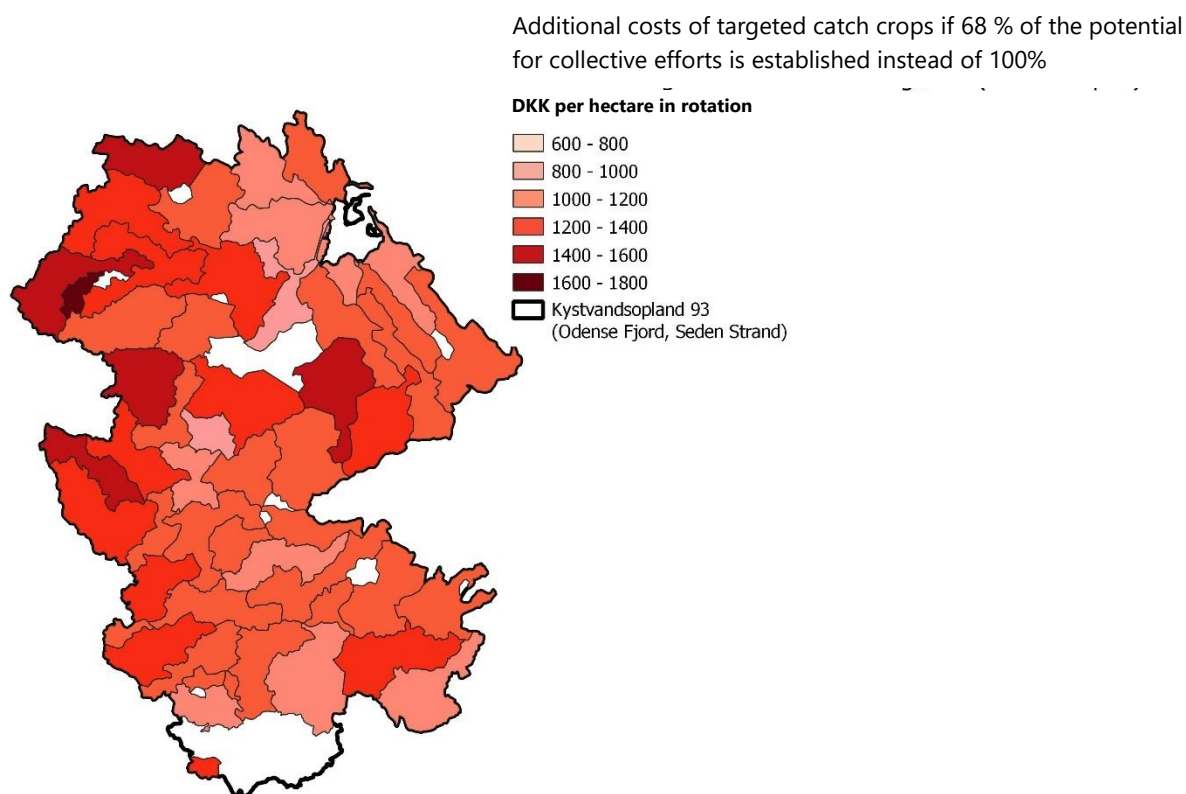

Figure 9. Additional costs if 68% of the potential for collective efforts is established instead of 100%

Distribution of costs between state and farms

The costs of the current targeted regulation will, to some extent, be covered by a subsidy to farms that register instruments on the cultivation surface in the voluntary scheme. In 2023, the subsidy was DKK 500 per hectare of catch crop, and it is not possible to get subsidies for N quota reduction. The subsidy rate has been calculated on the basis of averages, resulting in farms that are overcompensated while others are undercompensated.

With increased effort requirements, the difference in price between the instruments used on farms becomes even greater, making it even more difficult to create a compensation model for sharing costs between agriculture and the state.

Prices of instruments used

The prices of the instruments used are based on prices corresponding to the level from 2011-2020.

Wheat	130	DKK pr. hkg
Barley	125	DKK pr. hkg
Rye	115	DKK pr. hkg
Rapeseed	310	DKK pr. hkg
Oats	115	DKK pr. hkg
Corn silage	107	øre pr. FEN
Clover grass silage	128	øre pr. FEN
Ryegrass	900	DKK pr. hkg
Starch potatoes	65	DKK pr. hkg
Sugar beet	22	DKK pr. hkg
N	7	DKK pr. kg N
P	14	DKK pr. kg P
K	6,5	DKK pr. kg K
Straw	0,55	DKK pr. kg
Value of supplement protein	3,8	DKK pr. kg

Converted into prices per hectare of catch crop requirements that are solved with the instruments on the cultivation surface are shown in Figure 10. In order to preserve clarity in the figure, set-aside costs are not included in the figure. The cost of set-aside is calculated at prices between DKK 5,300 and DKK 8,400 per hectare. The lowest costs are for crop production on unirrigated JB1&3, while the highest costs are for livestock producers on JB2&4. The price of set-aside has been calculated on the assumption of the short term without capacity adjustment.

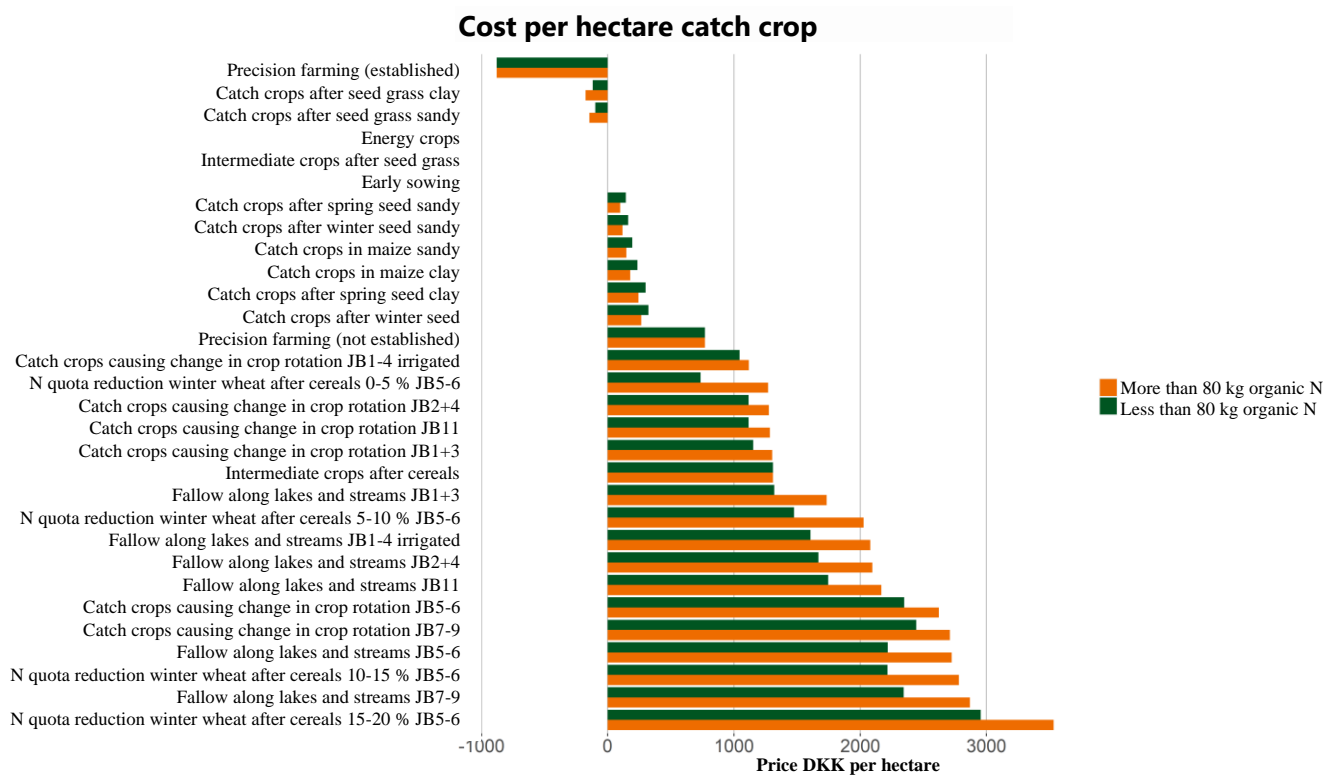

Figure 10. Cost per hectare catch crop requirements

References

Eriksen, J., Thomsen, I. K., Hoffmann, C. C., Hasler, B., Jacobsen, B. H. 2020. Virkemidler til reduktion af kvælstofbelastningen af vandmiljøet. Aarhus Universitet. DCA – Nationalt Center for Fødevarer og Jordbrug. 452 s. – DCA rapport nr. 174 <https://dcapub.au.dk/djfpdf/DCArapport174.pdf>

DCE 2021. Personal message. Hans Thodsen, Seniorrådgiver, Aarhus Universitet, BioScience. hath@bios.au.dk 87 15 87 91.

Validering af effekt af alternative virkemidler (AP 4.1)

Nutrient retention and carbon storage in the collective mitigation tools - A review.

Anders Barnewitz, Theis Kragh, Sara Egemose, Kasper Reitzel & Paula Canal-Vergés

Opsummering

I projektet er der blevet lavet et litteraturreview som samler massebalancerne for kvælstof (N), fosfor (P), og kulstof (C) for diverse anvendte våde virkemidler som har en effekt på en af de tre grundstoffer. I den sammenlignet litteratur fremgår det at mini-vådområder med en filtermatrice har en større fjernende effekt end traditionelle mini-vådområder, men samtidigt et højere globalt opvarmingspotentiale (GWP). Det ses dog også, at den fjernende effekt er proportionalt større end stigningen i GWP, og derfor et bedre værktøj, i den periode at værktøjet bliver vedligeholdt (som burde være i længere end 10 år). Vådområder er mindre effektive i N fjernelse end mini-vådområder, men kan også rumme et større opland, og har i modsætning til mini-vådområderne et negativt GWP, samtidigt med en høj kulstofbegravelse. Vådlægning af lavbundslande tilbageholder ikke nødvendigvis næringsstoffer, men har en evne til at holde på det kulstof der allerede er i jorden, og som vådområder både evnen til at lagre kulstof og have et negativt GWP. Det ses dog også at der er ekstremt stor variation i de tal som kan findes for lavbundslande (inkl. vådområder), hvilket skyldes vandspejlets store indflydelse på drivhusgasproduktionen. Regnvandsbassiner og separatkløakering er både effektive metoder til at håndtere den regn som falder i byerne, så længe regnvandsbassiner designes med moderne metoder.

Introduction

As a part of this project, we made an in-depth literature review for the currently applied measures which targets the freshwater (and associated nutrient balances) input at the source. The purpose is hence, to gather the in-literature numbers for nitrogen (N), phosphorus (P), and carbon (C), contextualize them and make them comparable.

For comparison, the carbon cycle was split into C/N/P sequestration and global warming potential (GWP). However, it should be considered that GWP is a measure which is not directly coupled to C, but rather the effect of the greenhouse gasses (GHG) carbon dioxide, methane, and nitrous oxide. The included measures selected come from river basin management plans (RBMPs) and climate adaptation plans (CAPs).

Mass balances

The RBMPs and CAPs focus on different success criteria and implementation targets. While the RBMP has a strong focus on the reduction of nitrogen and phosphorus to improve water quality (measured by the improvement of key parameters, e.g., phytoplankton, fauna indices, or eelgrass presence/distribution), the CAPs focus on the economic aspect to the protection of human infrastructure, although there are restrictions on the water quality. In the CAPs, climate mitigation actions, which aim to reduce GHG emissions or improve the storage capacity of carbon, are not fully applied or implemented and are partly dislodged from the actions planned to target climate adaptation. However, when planning mitigation action which involves nature (NBS), carbon, nitrogen, and phosphorus cycles cannot/should not be separated.

Nitrogen is especially important in the brackish and marine habitats, as it is often the nutrient regulating phytoplankton and macroalgae growth in those environments. Multiple factors are essential for maximizing N removal. Denitrification is the primary N removal pathway in many marine and freshwater systems. Denitrification is the step-by-step reduction of nitrate through the intermediate products nitrite, nitric oxide, and nitrous oxide to dinitrogen, which is then permanently removed from the system. Efficient denitrification is dependent on several factors, such as a steady supply of nitrate and labile organic matter, sufficient temperature to drive the microbial process, and conditions suitable for anaerobic respiration (Chandrasoma et al., 2019). These parameters are often found in systems with high water retention time, and a steady supply of organic matter (either through plant matter or artificially supplied), although denitrification may also occur in “hotspots” where plentiful organic matter results in area specific anaerobic zones (Christensen et al., 1990). A consequence of the nitrogen cycle is the production of nitrous oxide as a by-product. Nitrous oxide may either be produced through incomplete denitrification (as it is an intermediate product) or as a by-product of nitrification (the oxidation of ammonia through hydroxylamine and nitrite). In soil systems, nitrification is often linked as the process most responsible for nitrous oxide emissions, whereas drained peat soils account for >80% of the anthropogenic source, as they are already rich in organic matter, and are through fertilization supplied with an abundance of N (Davidson, 2012). Like most microbial processes, denitrification is thermosensitive, hence during periods of higher temperatures, N removal will be greater than during periods of low temperatures (Audet et al., 2021; Hoffmann et al., 2019; Ranalli & Macalady, 2010).

Phosphorus is usually the key nutrient to regulate in freshwater ecosystems, as many lakes suffer from a high P loading, which internalizes within the lakes, releasing P every summer when anoxia occurs. P cannot be removed from the system in the way that N may be; however, it binds to various compounds in the soil, e.g., humus and oxidized iron compounds (Parfitt et al., 1975). As it binds to soil compounds, an effective way of retaining the bound portion of P is sedimentation basins, where stagnant water allows particulate P to settle. To capture the dissolved P, it may be necessary to either increase the sediments capacity to bind P or create conditions where it can be incorporated into biomass. The sediment conditions which favor binding of P is a well oxygenated sediment, and the conditions which P is bound is therefore the opposite of the conditions which favor N removal.

The carbon cycle is slightly more complex, as carbon may be permanently removed from the system but primarily do so in two gaseous forms: carbon dioxide or methane, the two most important anthropogenic greenhouse gasses. To establish a desired climate benefit of the carbon cycle, containing carbon is necessary. Carbon buried in the sediment under reduced oxygen supply (similar conditions which favor denitrification) may result in hampered microbial activity due to the absence of oxygen (Keddy, 2010). These conditions will allow the stable organic matter (such as lignin and phenols) to remain in the soil for decades or centuries, contributing to a permanent removal. This burial of organic matter also contributes to the burial of N and P as they constitute organic matter.

To get a full overview of the effectiveness of an implemented measure it is necessary to account for the overall mass balance. This means a reduction in concentration is insufficient to prove alterations, as it is needed to account for the volume of water affected by a given concentration.

Traditionally, an applied measure, e.g., to reduce nutrient leaching to the coastal waters, is evaluated based on the mass balance of N, P, and C at the site of implementation, and in doing so,

may fail to capture potential effects at recipients. If nutrients are reduced at the source, reducing the load on the coastal environment, it may, as a result, increase the capability of seagrass meadows to form (which has receded rapidly due to eutrophication, (Hauxwell et al., 2003; Short & Burdick, 1996)). Seagrass, being a part of blue carbon, has the capacity to sequester carbon permanently (McLeod et al., 2011). A reduction in nutrient leaching from terrestrial sources, if combined with focused efforts in the coastal environment, may have an additional climate impact by increasing the distribution possibilities of blue carbon measures.

Methods

Table 4 Different measures included in the review, and which of the River Basin Management Plan or Climate Adaptation Plan the measure is included within.

In this review, the results will include all the official applied measures utilized in Denmark, focusing on the wet measures (table 1). There are many dry measures which could mitigate the need for wet measures (e.g., changed agricultural practices), however the scope of this review will exclude these, and focus on measures dealing with the water after it has been through either urban or agricultural areas, but before it reaches the recipient water body. These measures are for the non-urban areas are surface flow constructed wetlands, subsurface flow constructed wetlands, wetlands, and re-wetting of lowland areas. For the urban measures, there are many implementations within the urban area, and this review will focus on the water just before it reaches the recipient streams, and therefore includes stormwater ponds and separating wastewater from stormwater within the sewage system.

Measure	Plan
Edge-of-field measures	
Surface flow constructed wetland	RBMP
Subsurface flow constructed wetland	RBMP
Nature restoration	
Wetlands	RMBP
Re-wetted lowland	RMBP
Locally managed stormwater	
Stormwater pond	CAP
Sewer separation	

The literature search was conducted using Google Scholar. The search terms were constructed using Boolean strings to search using multiple names for each measure, while also including multiple terms for e.g., nutrient retention. First the titles were screened for exclusion, then the abstract, and then the full text. Inclusion criteria were that it had to be in the temperate region within Europe. For the edge-of-field measures, they had to clean agricultural runoff and not wastewater (which is another common application of these type of wetlands). To get a general overview, a search combining the search terms seen in table X was done, and the first 100 papers were screened for inclusion / exclusion. Due to the proportion of wastewater papers published on SSF-CW, an operator was included to exclude papers on wastewater.

Due to the nature of grey literature being dominant within these project-based measures, the grey literature may be included from official Danish reports where it is relevant.

To create a holistic view to be utilized in both water quality, but also climate contexts, this review has a focus on each measure effect on nutrients (N and P), along with carbon, in which sequestration and global warming potential is considered. The global warming potential (GWP) is calculated for the different measures based on IPCC (2014), where methane attributes has a 28 times higher global warming potential than carbon dioxide over a 100-year period, and nitrous oxide has a 273 times higher global warming potential than carbon dioxide over a 100-year period.

To enable a direct comparison between GWP and carbon sequestration rates, GWP is listed in C-eq rather than the common CO₂-equivalent (CO₂-eq).

In this review, literature has been reviewed for quantification of nutrient retention, carbon accumulation, and greenhouse gas emissions where relevant for different measures of CAPs and RBMPs, with a focus on results from Danish studies, although international studies have been included where applicable, or where Danish studies are lacking. Within this study, the measures included are shown in Table 1. The measures are categorized into three categories: those contained within the RBMPs, those contained within the CAPs, and some which are not officially included in either silo.

Results

Table 2 The TN retention, TP retention, carbon sequestration and global warming potential (GWP) of each of the measures included in this review. The GWP is listed as kg C-eq, to make it directly comparable to the carbon sequestration rates.

Measure	TN retention		TP retention		Carbon sequestration	GWP
	kg N ha ⁻¹ yr ⁻¹ (n)	% (n)	kg P ha ⁻¹ yr ⁻¹ (n)	% (n)		
SF-CW	422±263 (6)	40.7±24.6 (7)	84.4±122.7 (7)	20.1±37.3 (7)	-	4884±1166 (2, 3, 4)
SSF-CW	11405±5139 (2)	35.2±13.0 (2)	-1200±1745 (2)	-466±841 (3)	-	81351±42271 (1)
Wetlands	137±55 (5)	32.7±14.7 (2)	0.0±8.1 (4)	10.0±15.6 (2)	501±194 (3)	-1411±6370 (5, 5, 4)
Re-wetted lowland	-	-	-	-	3185±1875 (3)	-528±5145 (8, 8, 4)
Stormwater pond (wet)	-	45.5±31.7 (3)	-	44.4±36.6 (3)	524±331 (2)	2974±2233 (5, 5, 1)
Sewer separation	-	-	-	-	-	-

SF-CW: (Braskerud et al., 2005; Hoffmann et al., 2020; Kasak et al., 2022; Kynkäänniemi et al., 2013; Lavmić et al., 2020; Mander et al., 2021; Mendes & Renato, 2020; Mendes, 2021; Mendes et al., 2018; Stadmark & Leonardson, 2005; Steidl et al., 2019; Søvik et al., 2006; Tolomio et al., 2019; Vymazal, 2017)

SSF-CW: (Bruun et al., 2017; Hoffmann et al., 2020; Plauborg et al., 2023)

Wetland: (Audet et al., 2020a; Audet et al., 2013; Bianchi et al., 2021; Burden et al., 2019; Fortuniak et al., 2021; Herbst et al., 2011; Herbst et al., 2013; Hoffmann & Baatrup-Pedersen, 2007; Hoffmann et al., 2020; Kandel et al., 2019; Kieckbusch & Schrautzer, 2007; Taillardat et al., 2020; Walton et al., 2020)

Rewetted lowland soil: (Bianchi et al., 2021; Brown, 2017; Gyldenkerne, 2020; Huth et al., 2020; Kandel et al., 2020; Mrotzek et al., 2020; Peacock et al., 2019; Schrier-Uijl et al., 2014; Schwieger et al., 2021; Tiemeyer et al., 2020; Wilson et al., 2022)

Edge-of-field measures

In Denmark, the edge-of-field measures were included in the 2nd round of RBMPs, as a way to reduce the nutrient loading coming from agriculture directly at the source. Edge-of-field measures are locally implemented and function by targeting the diffuse nutrient leaching from agricultural land, where drainpipes traditionally go through buffer zones and dispose the drain water directly to the recipient streams. Edge-of-field measures works implementing a method of water detention by intersecting the drainpipes. This intersection allows to enhance conditions which favor N removal or P retention. The intersection of the drainpipes limits their implementation to drained soil, which in Denmark accounts for ~50% of the total cultivated area (Møller et al., 2018). There are two measures currently being implemented in Denmark (mini-wetlands with an open filter matrix and with a closed filter matrix, although internationally, they are similar to the surface- and subsurface flow-constructed wetlands (SF-CW & SSF-CW)), but there are other methods either in development or that are actively being implemented globally (Jaynes & Isenhardt, 2018; Wesström & Messing, 2007; Zak et al., 2018). While different in their execution, they typically follow similar setups; a phosphorous retention basin to trap particulate phosphorous, and water-saturated soil which enhance conditions suitable for denitrification (Audet et al., 2021; Carstensen et al., 2019a). There may be additional attempts to increase the amount of organic matter (by actively promoting vegetation), supplying the denitrifiers with electron donors, and thereby enhancing denitrification and nitrogen removal.

Surface flow constructed wetland (SF-CW)

The SF-CW is the primary measure being implemented in Denmark to reduce N load from agricultural land. Official requirements to ensure sufficient HRT and N removal is a size of 1-1.5 % of catchment area, and it must be constructed consisting of a sedimentation basin, followed by three basins (deep zones) separated by shallow zones. Additionally, the minimum size of the catchment area for implementation is 20 ha, and in order to get funding, the minimum estimated N removal must be 300 kg N ha⁻¹ yr⁻¹ (Danish Agricultural Agency, 2022). In the 6 studies included in this review on SF-CW, they found a mean retention of 422±263 kg N ha⁻¹ yr⁻¹ (n = 6), and in 7 studies there were a mean efficiency of 40.7±24.6 % (n = 7) removal of N (Table 2). On the phosphorous side, there were a retention of 84.4±122.7 kg P ha⁻¹ yr⁻¹ (n = 5), with a mean efficiency of 20.1±37.3 % (n = 8)(Table 2). The retention for N ranges between 87 and 856 kg N ha⁻¹ yr⁻¹, so although variable, has a definite effect on the N concentration, and may effectively reduce the N concentration when established. N retention occurs primarily through plant uptake and removal by denitrification, and plant uptake should reach an equilibrium, making denitrification the primary cause.

The P retention is more variable, and ranges from 0 to 321 kg P ha⁻¹ yr⁻¹, although the high retention is unlikely to occur. P retention occurs primarily through sedimentation, and optimizing the sedimentation basin is therefore of importance to ensure retention. The P retention is highly dependent on the P load and the hydraulic residence time, as higher loads and HRT increases the overall P retention (Mendes et al., 2018). There are also reports of P leaching occurring following establishment of SF-CW, increasing P by >200% (Sukias & Tanner, 2011; Ulén et al., 2019). The high variability makes the measure less effective at targeting P, and it should be used primarily as an N retention tool.

The GWP from SF-CW determined from the studies is 4884 ± 1166 kg C-eq. ha⁻¹ yr⁻¹ (n = (CO₂: 2, CH₄: 3, N₂O: 4))(Table 2). Carbon dioxide and methane accounts for most of the emissions, while nitrous oxide only accounts for ~12% of the GWP. High methane emissions from a shallow lake system is inevitable, especially one supplied with plenty labile carbon and nutrients which may result in an additional supply of labile carbon.

Sub-surface flow constructed wetland (SSF-CW)

The SSF-CW is an alteration of the SF-CW, consisting of a single basin (often also including a sedimentation pond), which is filled in with an organic substrate to fuel denitrification, and an inorganic material which supplies the microbes with surface area to grow and create a biofilm. In the Danish measure, the basin is filled with a combination of woodchips and seashells (some international variations may use another inorganic material, e.g., gravel (Bruun et al., 2016; Vymazal et al., 2020)). When the organic material is decomposed with time, replenishment will be necessary, and it has been suggested to add 0.5m of substrate every 6 years (Plauborg et al., 2023). As the measure has been reported to leach P following establishment (see section below), this renewal will likely be an additional source of P every few years. Some studies suggest that by allowing plant cover on top of the woodchips, the roots will supply the SSF-CW with additional source of organic matter, which could potentially extend the lifetime of the measure, or delay the addition of more woodchips (Zhai et al., 2013). Although the official size constraints of the SSF-CW is 0.2-0.25% of the catchment area, most of the Danish reported figures of TN and TP removal, along with GHG emissions, stem from a pilot study in which the SSF-CW was just 0.07% of the catchment (Carstensen et al., 2019b). Only a single study reports on the established measure which is not exclusively a pilot study.

The studies included report a N retention rate of 11405 ± 5139 kg N ha⁻¹ yr⁻¹ (n = 2), with an efficiency of $40.3 \pm 13.8\%$ (n = 2)(Table 2). The same studies report a P retention rate of -1200 ± 1745 kg P ha⁻¹ yr⁻¹ (n = 2) with an efficiency of $-466 \pm 841\%$ (n = 2)(Table 2). The added organic matter from woodchips may leach P (Carstensen et al., 2019b), increasing the organic matter concentration in the drain water to the recipient stream, with a study in the Czech Republic finding a potential increase of ~80-330%, which was highest during the weeks immediately after establishment, but still showed elevated concentrations after a year (Vymazal et al., 2020). SSF-CW are therefore highly effective at removing N, but the P retention may vary greatly, and it should be considered if the tool should be implemented upstream of a waterbody sensitive to P.

The added organic matter to increase N removal comes with a drawback, however, as the organic matter stimulates methane production when kept under anoxic conditions. Due to this stimulated microbial activity of SSF-CW, the method has a higher GWP of 81351 ± 42271 C-eq ha⁻¹ yr⁻¹ (n = 2)(Table 2). The HRT is the primary controlling factor of the GHG emissions, as a high HRT increases methane emissions, while a low HRT increases nitrous oxide and carbon dioxide emissions due to present oxygen (Audet et al., 2021; Bruun et al., 2017; Carstensen et al., 2019b; Davis et al., 2019). A lower HRT should reduce the GWP, as methane emissions account for 79% of the GWP in the studies included within this review. A lower HRT has been suggested as a method to circumvent the high emissions of the SSF-CW, but studies testing this also found that the efficiency in N removal was reduced from 98-100% to 27-32% by doing so (Carstensen et al., 2019a). Another method to reduce the GWP which has been suggested, is to not utilize the SSF-CW during the summer, when emissions are greatest (Eriksen et al., 2020).

Nature restoration / Area decommission

Nature restoration or area decommissioning covers two measures which, rather than being an edge-of-field measure, targets agricultural drain water, functioning by taking larger areas and restoring a natural hydrology. Wetlands have been drained to increase the area available for agricultural practices throughout time, which has reduced the total coverage of wetlands globally by 54-57% since 1900 (Davidson, 2014). Globally it has been estimated in the Global Wetland Outlook (2018) that there has been an 87% reduction in wetland distribution since the 1700s and a similar estimated reduction in Denmark since the 1800s. Wetland soils are unique in that they accumulate large quantities of carbon, and it is estimated that peatlands (a type of wetland) contain twice the amount of carbon of the global forests, despite covering just 3% of the world's terrestrial area (Global Wetland Outlook (2018)).

There are many reasons for restoring the original wetland hydrology, although the one which gets the most attention is for the climate. The accumulation of carbon has turned the soil into large carbon stocks, which was exposed to oxygen when the soil was drained, increasing the decomposition which started “burning” this carbon stock off. Ceasing draining wetlands is in part an attempt to stop or slow this process, reducing the carbon dioxide emissions, and in part a hope to restore the conditions which can start accumulating carbon once more, turning the areas into a carbon sink. Another reason to restore or establish wetlands in recent years has been to use them as nutrient removal zones, as the saturated soil rich in organic matter provides excellent conditions for denitrification. Denmark has two measures, each targeting one aspect: Re-establishment of wetlands with the primary purpose to reduce nutrient leaching, and re-wetting organic lowland soil to stop the release of carbon dioxide.

Rewetting of lowland soil

Re-wetting lowland soil is a measure which ceases cultivation and ceases the practice of tile drain in the area, allowing the water table to rise to natural levels. The organogenic (defined as >12% organic carbon content) soils have been estimated to be responsible for GHG emissions in the range of ~10900-13600 kg C-eq ha⁻¹ yr⁻¹ when drained to agricultural norms (Gyldenkærne, 2020). When draining is ceased and the water table returned to near the surface, the decomposition slows down, restoring the soil carbon as a permanent stock.

Lowland soils are often independent of riverine systems, and therefore do not functionally have any retention of nutrients, as there is no input. However, Danish reports estimate previously cultivated land fertilized at high- and moderate intensity leach 22-25 kg N ha⁻¹ yr⁻¹ and 2-5 kg N ha⁻¹ yr⁻¹ respectively, with a national average of 12 kg N ha⁻¹ yr⁻¹ (Eriksen et al., 2020). This corresponds to an 80% reduction relative to the Danish mean leaching from agricultural soil of 59 kg N ha⁻¹ yr⁻¹ (Blicher-Mathiesen, 2020). If established with a higher water level, denitrification within the soil should make leaching negligible in the long term. Re-wetting soil results in a rapid change in redox conditions, reducing iron which may release the iron-bound P. This results in a potential P leaching from the soil after establishment. It has been suggested that prior to rewetting, removing the topsoil (25 cm) reduces N and P leaching by 80% and 93% respectively (Harpenslager et al., 2015). This treatment, however, removes bound carbon from the site, which re-wetting is intended to permanently trap, potentially allowing it to decompose and emit GHG elsewhere. Danish reports suggest that by re-wetting organogenic soil, phosphorous leaching will be reduced by erosion-leaching ceasing (Andersen et al., 2020).

The measure is primarily intended to reduce GHG emissions from the degrading organogenic soils. Multiple studies have found that the primary controlling factor on GHG emissions from lowland organogenic soils is the water table (Abdalla et al., 2016; Eickenscheidt et al., 2015; Evans et al.,

2021; Kandel et al., 2020; Tiemeyer et al., 2016; Tiemeyer et al., 2020; Wilson et al., 2016). When lowland soil is converted to agricultural use, it is typically drained to >50-80 cm below the surface. Methane-, carbon dioxide-, and nitrous oxide emissions are all regulated by the water table. When the water table is low, the soil is exposed to oxygen, resulting in higher carbon dioxide and nitrous oxide emissions (Evans et al., 2021; Tiemeyer et al., 2020). When the water table is high (especially if it is above the surface), carbon dioxide and nitrous oxide emissions are reduced, but the methane emissions rise (Gyldenkærne, 2020; Tiemeyer et al., 2016; Tiemeyer et al., 2020). This inverse relationship between methane and carbon dioxide emissions based on water table is also evident in the studies included in this review (Figure 1).

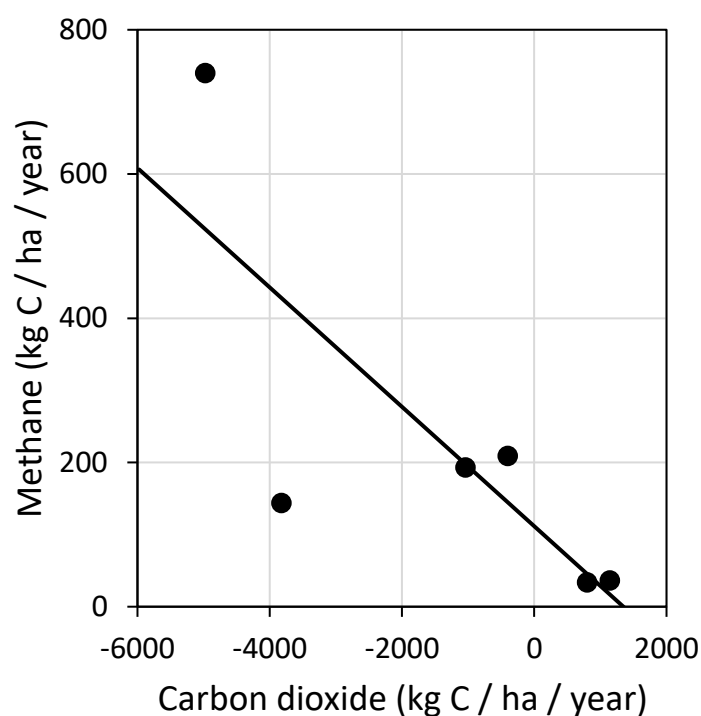

Figure 49 Methane emissions as a function of carbon dioxide emissions from 6 studies on greenhouse gas emissions from re-wetted lowland soil. The solid line is the linear regression.

In Denmark, emissions from organogenic soil are calculated on the assumption that soil with 6-12% OC emits half as much GHG as soils with >12% OC. These assumptions are in contrast to findings in German studies on organogenic soil, which found no difference in GHG emissions between the soil of 5-10% and 16-18% OC (Eickenscheidt et al., 2015; Tiemeyer et al., 2016; Tiemeyer et al., 2020). This is likely due to soil with lower organic content having a higher carbon density, resulting in more carbon exposed per area drained, making a direct correlation challenging (Gyldenkærne, 2020). This could result in a potential underestimation of emissions from soils with 6-12% OC but also an underestimation of the reduction when reintroducing natural hydrological conditions to these soils. By raising the water table, the emissions from lowland soils become negligible, especially if kept at ~10 cm below the surface, which reduces carbon dioxide emissions while keeping the methane emissions low (Evans et al., 2021). When re-wetting lowland soil, a reduction in GWP of ~86% is expected (Tiemeyer et al., 2020). Although re-wetted lowland soil may potentially still be positive GWP emitters, it is important to consider the reduced emissions by raising the water table. Using the lower boundary of the estimated emissions from drained lowland soil, a 86% reduction in emission would be equivalent to ~9400 kg C-eq ha⁻¹ yr⁻¹, far outweighing the sequestration of any other measure (Gyldenkærne, 2020; Tiemeyer et al., 2020). The studies included in this review found a carbon sequestration of 3185±1875 kg C ha⁻¹ yr⁻¹ (n = 3), and a GWP of -528±5145 kg C-eq ha⁻¹ yr⁻¹ (n = (CO₂: 8, CH₄: 8, N₂O: 4)) (Table 2). The added carbon sequestration on top of the reduced emissions makes the organogenic lowland soils an effective measure to dampen the rising greenhouse gas emissions. It is clear from the studies on GWP that there is great variability, especially in the carbon dioxide and methane emissions, which are tightly linked to the water table. It is therefore not possible to determine the GWP of an organogenic soil with a simple number, as the soil conditions and water table are key determining parameters. It

would appear that if the water table is managed to levels where methane production remains low, the GWP should also remain low.

Wetlands

Wetlands differentiate themselves from the re-wetting of lowland soil, in that they are typically established as riverine wetlands, in direct connection to flowing water. They are typically in combination with other re-establishment measures such as meandering of the stream (which permits periodic inundation during periods of high hydraulic load), and drain irrigation, where the nearby drains are redirected onto the wetland for N removal through denitrification (Hoffmann & Baattrup-Pedersen, 2007). It is a measure that has been utilized in Denmark to target nutrient removal since 1998, with many Danish sites having been established. Often, the followed monitoring occurs only within the first year after establishment, resulting in lackluster verification of the long-term effectiveness (Eriksen et al., 2020). Concerns has been raised that when utilizing wetlands as this kind of nutrient filter, the increased nutrient flow through the wetlands fail to mimic historically nutrient-poor wetlands, and therefore the biodiversity within the wetlands remain limited (Hambäck et al., 2023).

In a Danish study of 13 wetlands, they found a TN removal of 156.3 ± 103.4 kg N ha⁻¹ yr⁻¹ (Eriksen et al., 2020). This is within the same interval as the studies included in this review which found a TN removal of 137 ± 55 kg N ha⁻¹ yr⁻¹ (n = 5), with an efficiency of $32.6 \pm 14.7\%$ (n = 2) (Table 2). The TP retention is more uncertain, with a removal rate of 0.04 ± 8.10 kg P ha⁻¹ yr⁻¹ (n = 4), and an efficiency of $10.0 \pm 15.6\%$ (n = 2) (Table 2). P is expected to leach when the wetland is established on previously agricultural fields, as like re-wetted lowland soil, a re-introduction of a higher water table causes a change in the redox conditions, reducing iron and releasing P (Kieckbusch & Schrautzer, 2007). An equilibrium is expected to form, however, the time frame for this equilibrium is uncertain, although the period is likely >5 years (Audet et al., 2020b). The primary P retention mechanism is sedimentation during periods of inundation (Kronvang et al., 2007).

Overall, wetlands have a carbon sequestration rate of 501 ± 194 kg C ha⁻¹ yr⁻¹ (n = 3), and a GWP of -1411 ± 6370 (n = (CO₂: 4, CH₄: 6, N₂O: 4)) (Table 2). The GWP is very dependent on the water table, similar to lowland areas, as a high water table (either at or above the surface) results in higher methane emissions, whereas a lower water table (~20-30 cm below the surface) mitigates much of the methane emissions, but has higher carbon dioxide and nitrous oxide emissions (Audet et al., 2013). A study of a temperate wetland demonstrated that during wet years, wetlands might be a GWP sink, whereas during dry years, they may act as a source due to the decreased water table (Fortuniak et al., 2021). Globally, wetlands represent >50% of the natural methane emissions and ~25% of the total methane emissions (IPCC, 2014). Despite their GWP, wetlands are utilized as a climate mitigation tool due to their ability to sequester carbon due to their water-saturated, reduced conditions, and it is estimated that wetlands contain 12-35% of the worlds soil C stock, despite only covering 5-8% of the area (Villa & Bernal, 2018). Furthermore, the popularity of wetlands restoration has as well been promoted to compensate for their area reduction in the past decades (Davidson, 2014; Were et al., 2019). Carbon sequestration in wetlands occurs as a combination of biomass production being buried under reduced conditions, preventing full mineralization, and by accretion of the wetland during inundation (Villa & Bernal, 2018). And although there are high emissions from wetlands on a global scale, there is a large variability on the definition of a wetland, where certain types produce disproportionately more methane than others, such as shallow lakes, as the water table is permanently above the surface, but the water column is too shallow to oxidize the methane (Petersen et al., 2022).

Stormwater Management

With increasing urbanization throughout the world, there has been a rising need for managing stormwater. The urban environment is characterized by paved roads, great parking lots, and roofed buildings. The introduction of many urban structures introduces impermeable surface area. The impermeable surface area thus results in a quick discharge of stormwater. During a rain event, stormwater is usually captured, stored, or delayed by vegetation and soil, which causes a delay and reduction in the water at the recipient, e.g., a nearby stream. When water is discharged quickly, there is no retention, and no delay, resulting in high water loads in streams, of which there are two outcomes: the stream can contain the water, but the water velocity causes significant erosion, or the stream cannot handle the water, causing local flooding. Streams coming out of urban areas has been characterized by the “urban stream syndrome”, which describes a stream with quickly altering water flow, high nutrients, erosion which can alter the stream morphology, and a higher content of tolerant and invasive species (Walsh et al., 2005). This results in either ecological or economic damage. To mitigate those, climate adaptation tools have been developed to retain and delay urban runoff.

Stormwater ponds

Stormwater ponds are common in urban areas and have been utilized for decades to manage the high urban runoff, which occurs as a result of the high proportion of impermeable surfaces. The runoff has been increasing due to climate change, and stormwater ponds therefore function as a climate adaptation measure to protect against flooding, pollution, and erosion. In recent years, increasing attention has been brought to the potential multifunctionality that stormwater ponds may serve, such as increasing biodiversity and the ability to retain nutrients. This has created a shift in the type of stormwater ponds being established, whereas previously, the most common were simplistic dry or wet ponds. The recent development has expanded the possibilities of adding filters in wet ponds to remove particles and having an overflow mechanism that re-directs incoming water to the recipient, capturing only the most nutrient-rich “first flush” within the pond for treatment (Egemose, 2018; Egemose et al., 2020). These are additions that enhance the nutrient retention capacity by either increasing the retention within the pond or maximizing the nutrient mass withheld in the pond.

For nutrients, the primary focus is on P in stormwater ponds, as 40-80% of the N leaching from urban areas are coming from atmospheric deposition, and the anthropogenic contribution is therefore limited (Troitsky et al., 2019). Urban P comes from many sources, such as erosion of building materials, vehicle pollution etc. (Egodawatta et al., 2012; Indris et al., 2020). Nutrients are retained within stormwater ponds through both removal (denitrification) and retention (sedimentation). Both processes are enhanced by increasing water residence time, making wet ponds more effective than dry ponds (Koch et al., 2014). The effectiveness may be improved by utilizing filters at the outlet (e.g., sand), which increases the retention of particulates. The effectiveness of the filters is reduced over time (within 5-10 years) due to clogging of the filter (Egemose, 2018; S nderup et al., 2016). If maintained, such a filter may result in higher particulate nutrient retention (Egemose, 2018). Stormwater ponds can be efficient in retaining nutrients; however, many factors influence the retention capacity, such as type, catchment area, nutrient loading, retention time, and age (Koch et al., 2014; S nderup et al., 2016). Within the stormwater literature, it appears that mass retention is not utilized, and the efficiency at retaining N and P is the focus. The overall retention efficiency in the included studies is $45.5 \pm 31.7\%$ for TN ($n = 3$) and $44.4 \pm 36.6\%$ ($n = 3$) for TP (Table 2). In order to maximize retention, the residence time has to be sufficient to allow particles to sediment (Janke et al., 2022). Generally, the suggested dimensions are greater than $150\text{-}250 \text{ m}^3$ reduced hectare⁻¹ (the reduced area is the impermeable surface area

within the catchment) for the permanently wet proportion of the stormwater pond, with a distance between inlet and outlet of >80 meters (Hvitved-Jacobsen et al., 2010; Sønderup et al., 2016).

Due to the high sedimentation rates found in stormwater basins combined with the potential for vegetative growth, carbon sequestration/accumulation may occur. Carbon sequestration (accumulation) in the sediment of vegetated stormwater ponds was found to be $524 \pm 331 \text{ kg C ha}^{-1} \text{ yr}^{-1}$ (Table 2). There are multiple American studies which report accumulation rates of $\sim 800 \text{ kg C ha}^{-1} \text{ yr}^{-1}$, which is in the same order of magnitude (Kavehei et al., 2018; Merriman et al., 2017; Moore & Hunt, 2012; Schroer et al., 2018). As stormwater ponds require regular maintenance to sustain their function, removal of sediment is a necessary element, and depending on how the sediment is stored, would have an impact on fate of the carbon.

Stormwater ponds are frequently permanently inundated for a portion of the covered area, which like wetlands, creates conditions favorable for greenhouse gasses to be produced and emitted. There is a high variability in the GWP potential reported, although a mean GWP of $2974 \pm 2233 \text{ kg C ha}^{-1} \text{ yr}^{-1}$ ($n = (\text{CO}_2: 5, \text{CH}_4: 5, \text{N}_2\text{O}: 1)$) (Table 2). One study in Sweden found that when upscaling the GWP to the total stormwater pond area cover in Sweden, stormwater ponds would account for 0.1% of the agricultural GWP, making them negligible in comparison (Peacock et al., 2019).

Sewer separation

Sewer separation functions by separating the wastewater portion of the sewage from the stormwater portion, re-directing the stormwater to a recipient waterbody, whereas the wastewater flows to wastewater treatment plants. Separate sewers have been increasingly implemented in Denmark, although limitations in implementation exist in older urban areas, e.g., areas of Copenhagen cannot be converted. Combined sewers have multiple negative effects during high precipitation events. If high precipitation occurs, there is an increased risk of overflow from the sewers, which would, in the case of combined sewers, include sewage waste and could potentially pose a health risk (Balasa et al., 2021; Donovan et al., 2008; Rodríguez et al., 2012). Another issue arises when the wastewater treatment plants receive a higher volume of water than they can handle, which results in overflow directly to streams. Untreated wastewater may contain concentrations of TN and TP in the ranges of 35-100 mg/L and 18-29 mg/L, respectively (Rout et al., 2021). Wastewater treatment has been increasingly effective in the past decades, and separate sewers ensure that overflow events do not occur, and increasing the retention time within the wastewater treatment plant, ensures more efficient treatment (Frank-Gopolos, 2020). In Denmark, in 2020, 95% of wastewater treatment plants were of the MBNDK type (mechanical-, biological-, nitrifying-, denitrifying-, and chemical removal), which has a removal efficiency of 90% of TN, and 94% of TP (COWI, 2019; Frank-Gopolos, 2020).

The Danish point source report found that in 2020, although combined sewers only accounted for 10.8% of the point source water, they contributed 44.2% and 50.4% of the TN and TP emissions (Frank-Gopolos, 2020). Using these reported emission numbers, changing from combined sewers to separate sewers would result in a reduction in TN and TP point source emissions of 85% and 88%, respectively (Frank-Gopolos, 2020). A note has been made, however, that although separate sewers are effective in reducing nutrient loads, they result in increased pollution of heavy metals, as the urban runoff contains high concentrations of these, and are directly discharged to the recipient without treatment (Brombach et al., 2005; Gasperi et al., 2010).

Discussion

After many years of environmental decline in the coastal areas, it has become apparent that the restoration of certain native habitats such as eelgrass meadows, is difficult, due to fjords environmental conditions at the fjord have changed significantly during their years of absence (Flindt et al., 2023; Valdemarsen et al., 2010). After the many years of eutrophication, one of the significant alterations is the increment of organic reach muddy sediments, low light conditions and high levels of inorganic nutrients etc., preventing transplantation or natural formation in large areas (Flindt et al., 2023; Valdemarsen et al., 2010). Eelgrass is as well a key indicator for good quality status in the Danish water framework directive (WFD), hence has extensive national focus. Eutrophication is as stated the underlying cause of this species lack of recovery hence keeping most Danish water bodies as bad to very bad water quality in the WFD. Hence, it is crucial that the nutrient load to the fjords is decreased further before restoration should be initiated. The Danish government is hoping to improve water quality status by a volunteer program, in which field owners sign up to projects, implementing measures. The effectiveness of the measures is therefore extremely important.

The edge-of-field measures are highly targeted, and therefore can reduce high N load straight at the source where the concentration is highest, and the microbial processes should be the most efficient. However, in the volunteer arrangement, it is listed as necessary to maintain the measures for a period of 10 years, after which it is voluntary. This makes the measure extremely short-term, and therefore highly questionable to implement big scale, as the effectiveness may then run out eventually. The efficiency is reflected in the numbers from the literature, and TN is removed efficiently by both measures (422 ± 263 and 11405 ± 5139 kg N ha⁻¹ yr⁻¹ for SF-CW and SSF-CW respectively). Although SSF-CW is 27 times more efficient at removing TN, it is also accompanied by a significantly higher GWP, which is 16 times higher than SF-CW. It is therefore more climatically efficient, as the TN removal per GWP is higher. There is overall a lack of published studies on SSF-CW that treats agricultural drainage water in the temperate region, but as the measure is widely implemented to treat wastewater (Vymazal, 2007), it is likely a robust method. The biggest drawback is the maintenance requirements, as this requires additional woodchips after a set cycle (6 years, Plauborg et al. (2023)). Due to the SSF-CW being a bioreactor, there are studies which suggest improvements, such as altering the microbial composition to favor microbes which are more efficient during the winter period (Jéglot et al., 2021). It has potential but is held back by the upkeep requirements.

Due to the high demand of nutrient reduction, there are a bunch of alternative edge-of-field measures in development. The ones receiving the most attention are saturated buffer zones, integrated/intelligent buffer zones. Saturated buffer zones and integrated/intelligent buffer zones optimize the saturation of soil by being an elongated measure stretching along the streams, forcing the water to infiltrate the soil, utilizing vegetation for organic carbon (Jaynes & Isenhardt, 2018; Zak et al., 2018). Saturated buffer zones do this by utilizing perforated drainpipes which run along the streams, while integrated/intelligent buffer zones are essentially elongated SF-CW which is drained by infiltration. The literature on saturated buffer zones is limited, although it is potentially equal to SF-CW in terms of TN retention (Jaynes & Isenhardt, 2018). Integrated/intelligent buffer zones are studied in Denmark, and the studies so far suggests a TN retention of 1683 ± 670 kg N ha⁻¹ yr⁻¹, while being equal to SF-CW in GWP (Carstensen et al., 2021; Zak et al., 2018; Zak et al., 2019). Overall, the elongated design could prove to be an improvement, while at the same time functioning as a widened buffer zone, although more studies would be beneficial. For all measures, it is common that phosphorous retention is highly variable, and in general the edge-of-field measures are not good as a phosphorous trap (Table 2).

The wetland- and rewetting of lowland soil measure primarily function on the principle of restoring natural hydrology. Natural hydrology on its own brings along multiple benefits, as permanently water saturated soil is one of the few permanent carbon storage solutions we can utilize. The extensive drainage of our soil has enabled the carbon within the soil to be released into the atmosphere, degrading the soils utility for cultivation, adding to the increasing greenhouse gasses, and reducing the ability of the soil to be the efficient N filter that it can be. Restoring natural hydrology will start the process of carbon built-up in the soil once more, but it is not a rapid process. It is very clear that both of these measures are immensely affected by the water table, and managing the water table is essential to optimize the climate benefits (Tiemeyer et al., 2020). There is high variability in the results, and the high variability can be attributed to differences in water table conditions in each study, which causes high variation in carbon dioxide and methane emissions (Appendix fig. 1). The wetlands have the added purpose of being a TN retention tool, as it is often combined with drain irrigation, and it is effective at doing, as it does not target the source in the same way the edge-of-field measures do. Phosphorous retention is highly variable, and especially in the years following establishment, high leaching of P may occur, although it may leach less once an equilibrium is formed (Audet et al., 2020a). It should be expected that when the carbon content within the soil increases, so does the ability to denitrify N, and the retention could increase long-term.

Although a lot of conclusions are drawn on the extensive study of Tiemeyer et al. (2020), their findings on methane emissions increasing when the water table is high, and carbon dioxide increasing the water table is low, is consistent with the studies included in this review (Figure 1). Overall wetlands (Rewetted lowland soil and wetlands) are an effective and necessary measure to reverse the trend of global wetland coverage in recent decades, and to cease the loss of bound carbon in the soil. Care should be taken when establishing it, ensuring the optimal GWP by preventing a constantly high water table, preferably it should remain around ~10 cm below the surface (Tiemeyer et al., 2020).

The two of the most important stormwater management measures stormwater ponds and sewer separation are heavily implemented already, and a lot of development has been done over the years. Especially stormwater ponds have been through many modifications, which may vastly improve the nutrient retention (Sønderup et al., 2016). On carbon it is much more difficult to assess, but it is expected that it would have a moderate GWP as it is a lake receiving polluted water, however considering the benefits of stormwater ponds, it should not be a limiting factor. Although there are studies which have shown carbon sequestration rates, the concept in a measure which requires regular cleaning to maintain its function becomes redundant, and it should not be included in considerations. Sewer separation ensures efficient cleaning of the water directed to the wastewater treatment plants, however, concerns has been raised that due to the frequency of overflows (if they do not occur often), recipients may have a higher nutrient load (especially P) after separation, if the rainwater is not going through the wastewater facility anymore, but is directly emitted to the streams (Egemose, pers. comm.). This could potentially be minimized by ensuring that sewer separation is combined with an appropriately built stormwater pond. As it is the municipalities responsibility to emit clean water to the recipients, and in their best interest, the stormwater pond is more likely to be efficient or optimized after a period, differentiating it from e.g., SF-CW.

There are many studies on the blue carbon aspect of seagrasses, with one of the most cited references showing burial rates of $1380 \pm 380 \text{ kg C ha}^{-1} \text{ yr}^{-1}$ (Duarte et al., 2013). A thorough study of the Danish *Zostera marina* is currently in work which challenges these high figures for carbon burial (Flindt et al., in prep). It can be consider that the potential of eelgrass storage lays on the

living biomass (winter biomass), whereas the storage in sediments is highly affected by the beds morphology and the area hydrodynamic. Specific rates, and consideration will be shown in Flindt et al in Prep. However, the carbon storage capacity likely will be reduced compared to Duarte et al 2013. Odense Fjord has lost 2490 ha of its historical eelgrass distribution (de los Santos et al., 2019). In 1908 it was estimated that eelgrass could grow as deep as 6.7 meters of depth, which may now be considered pristine conditions. Now, that range has been reduced to <2.5 meters a decade later (Ostenfeld, 1908; Riisgård et al., 2008). Hence the system have lost a large standing stock, which have reduce the system capacity to store both Carbon, Nitrogen and Phosphorus for at least a full season.

Even if we disregard carbon, extensive eelgrass coverage has nutrient benefits, as it has been well demonstrated that within eelgrass beds, denitrification is highly efficient, as they create a big surface area for biofilm to adhere to while providing the organic matter to fuel denitrification (Zarnoch et al., 2017). A big effort to reduce nutrient loading in the catchment areas would therefore lead to greater reductions due to the added reduction in the coastal areas, giving the coastal areas a greater capacity to deal with years of higher loading and fluctuations. Focusing on measures which are going to be effective long-term will be the optimal way to restore the natural function of the elemental cycling, where the coastal areas can thrive.

References

- Abdalla, M., Hastings, A., Truu, J., Espenberg, M., Mander, Ü., & Smith, P. (2016). Emissions of methane from northern peatlands: a review of management impacts and implications for future management options [<https://doi.org/10.1002/ece3.2469>]. *Ecology and Evolution*, 6(19), 7080-7102. <https://doi.org/https://doi.org/10.1002/ece3.2469>
- Andersen, H. E., Rubæk, G. H., Hasler, B., Jacobsen, B. H., Heckrath, G. J., Olsen, P., Munkholm, L. J., Hoffmann, C. C., Zak, D. H., & Kronvang, K. B. (2020). Virkemidler til reduktion af fosforbelastningen af vandmiljøet.
- Audet, J., Carstensen, M. V., Hoffmann, C. C., Lavaux, L., Thiemer, K., & Davidson, T. A. (2020a). Greenhouse gas emissions from urban ponds in Denmark. *Inland Waters*, 10(3), 373-385. <https://doi.org/10.1080/20442041.2020.1730680>
- Audet, J., Elsgaard, L., Kjaergaard, C., Larsen, S. E., & Hoffmann, C. C. (2013). Greenhouse gas emissions from a Danish riparian wetland before and after restoration. *Ecological Engineering*, 57, 170-182. <https://doi.org/https://doi.org/10.1016/j.ecoleng.2013.04.021>
- Audet, J., Jégliot, A., Elsgaard, L., Maagaard, A. L., Sørensen, S. R., Zak, D., & Hoffmann, C. C. (2021). Nitrogen removal and nitrous oxide emissions from woodchip bioreactors treating agricultural drainage waters. *Ecological Engineering*, 169, 106328. <https://doi.org/https://doi.org/10.1016/j.ecoleng.2021.106328>
- Audet, J., Zak, D., Bidstrup, J., & Hoffmann, C. C. (2020b). Nitrogen and phosphorus retention in Danish restored wetlands. *Ambio*, 49(1), 324-336. <https://doi.org/10.1007/s13280-019-01181-2>
- Balasa, G., Levengood, E. S., Battistelli, J. M., & Franklin, R. B. (2021). Diversity of Multidrug-Resistant Bacteria in an Urbanized River: A Case Study of the Potential Risks from Combined Sewage Overflows. *Water*, 13(15), 2122. <https://www.mdpi.com/2073-4441/13/15/2122>
- Bianchi, A., Larmola, T., Kekkonen, H., Saarnio, S., & Lång, K. (2021). Review of Greenhouse Gas Emissions from Rewetted Agricultural Soils. *Wetlands*, 41(8), 108. <https://doi.org/10.1007/s13157-021-01507-5>
- Blicher-Mathiesen, G., Houlborg, T., Petersen, R. J., Rolighed, J., Andersen, H. E., Jensen, P. G., Wienke, J., Hansen, B., Thorling, L. (2020). *Landovervågningsoplände 2020*.
- Braskerud, B. C., Tonderski, K. S., Wedding, B., Bakke, R., Blankenberg, A. G. B., Ulén, B., & Koskiahio, J. (2005). Can Constructed Wetlands Reduce the Diffuse Phosphorus Loads to Eutrophic Water in Cold Temperate Regions? *Journal of Environmental Quality*, 34(6), 2145-2155. <https://doi.org/https://doi.org/10.2134/jeq2004.0466>
- Brombach, H., Weiss, G., & Fuchs, S. (2005). A new database on urban runoff pollution: comparison of separate and combined sewer systems. *Water Science and Technology*, 51(2), 119-128.
- Brown, E. L. (2017). *Greenhouse gas flux response to restoration management in UK lowland peatlands*. Bangor University (United Kingdom).
- Bruun, J., Hoffmann, C. C., & Kjaergaard, C. (2016). Nitrogen Removal in Permeable Woodchip Filters Affected by Hydraulic Loading Rate and Woodchip Ratio. *Journal of Environmental Quality*, 45(5), 1688-1695. <https://doi.org/https://doi.org/10.2134/jeq2015.11.0583>
- Bruun, J., Hoffmann, C. C., & Kjaergaard, C. (2017). Convective transport of dissolved gases determines the fate of the greenhouse gases produced in reactive drainage filters. *Ecological Engineering*, 98, 1-10. <https://doi.org/https://doi.org/10.1016/j.ecoleng.2016.10.027>
- Burden, A., Garbutt, A., & Evans, C. (2019). Effect of restoration on saltmarsh carbon accumulation in Eastern England. *Biology letters*, 15(1), 20180773.
- Carstensen, M. V., Børgesen, C. D., Ovesen, N. B., Poulsen, J. R., Hvid, S. K., & Kronvang, B. (2019a). Controlled Drainage as a Targeted Mitigation Measure for Nitrogen and Phosphorus.

- Journal of Environmental Quality*, 48(3), 677-685.
<https://doi.org/https://doi.org/10.2134/jeq2018.11.0393>
- Carstensen, M. V., Larsen, S. E., Kjærgaard, C., & Hoffmann, C. C. (2019b). Reducing adverse side effects by seasonally lowering nitrate removal in subsurface flow constructed wetlands. *Journal of Environmental Management*, 240, 190-197.
<https://doi.org/https://doi.org/10.1016/j.jenvman.2019.03.081>
- Carstensen, M. V., Zak, D., van't Veen, S. G. M., Wisniewska, K., Ovesen, N. B., Kronvang, B., & Audet, J. (2021). Nitrogen removal and greenhouse gas fluxes from integrated buffer zones treating agricultural drainage water. *Science of The Total Environment*, 774, 145070.
<https://doi.org/https://doi.org/10.1016/j.scitotenv.2021.145070>
- Chandrasoma, J. M., Christianson, R. D., & Christianson, L. E. (2019). Saturated Buffers: What Is Their Potential Impact across the US Midwest? *Agricultural & Environmental Letters*, 4(1), 180059. <https://doi.org/https://doi.org/10.2134/ael2018.11.0059>
- Christensen, S., Simkins, S., & Tiedje, J. M. (1990). Spatial Variation in Denitrification: Dependency of Activity Centers on the Soil Environment. *Soil Science Society of America Journal*, 54(6), 1608-1613. <https://doi.org/https://doi.org/10.2136/sssaj1990.03615995005400060016x>
- COWI. (2019). *Virkemidler over for punktkilder*.
- Danish Agricultural Agency. (2022). *Minivådområdeordningen 2022 - Etablering af åbne minivådområder*.
- Davidson, E. A. (2012). Representative concentration pathways and mitigation scenarios for nitrous oxide. *Environmental Research Letters*, 7(2), 024005. <https://doi.org/10.1088/1748-9326/7/2/024005>
- Davidson, N. C. (2014). How much wetland has the world lost? Long-term and recent trends in global wetland area. *Marine and Freshwater Research*, 65(10), 934-941.
<https://doi.org/10.1071/MF14173>
- Davis, M. P., Martin, E. A., Moorman, T. B., Isenhardt, T. M., & Soupir, M. L. (2019). Nitrous oxide and methane production from denitrifying woodchip bioreactors at three hydraulic residence times. *Journal of Environmental Management*, 242, 290-297.
<https://doi.org/https://doi.org/10.1016/j.jenvman.2019.04.055>
- Donovan, E., Unice, K., Roberts, J. D., Harris, M., & Finley, B. (2008). Risk of gastrointestinal disease associated with exposure to pathogens in the water of the Lower Passaic River. *Applied and Environmental Microbiology*, 74(4), 994-1003.
- Duarte, C. M., Losada, I. J., Hendriks, I. E., Mazarrasa, I., & Marbà, N. (2013). The role of coastal plant communities for climate change mitigation and adaptation. *Nature Climate Change*, 3(11), 961-968. <https://doi.org/10.1038/nclimate1970>
- Egemose, S. (2018). Removal of particulate matter and phosphorus in sand filters treating stormwater and drainage runoff: a case study. *Urban Water Journal*, 15(4), 388-391.
<https://doi.org/10.1080/1573062X.2018.1479435>
- Egemose, S., Petersen, A. B., Sønderup, M. J., & Flindt, M. R. (2020). First Flush Characteristics in Separate Sewer Stormwater and Implications for Treatment. *Sustainability*, 12(12), 5063. <https://www.mdpi.com/2071-1050/12/12/5063>
- Egodawatta, P., Miguntanna, N. S., & Goonetilleke, A. (2012). Impact of roof surface runoff on urban water quality. *Water Science and Technology*, 66(7), 1527-1533.
<https://doi.org/10.2166/wst.2012.348>
- Eickenscheidt, T., Heinichen, J., & Drösler, M. (2015). The greenhouse gas balance of a drained fen peatland is mainly controlled by land-use rather than soil organic carbon content. *Biogeosciences*, 12(17), 5161-5184. <https://doi.org/10.5194/bg-12-5161-2015>

- Eriksen, J., Thomsen, I. K., Hoffmann, C. C., Hasler, B., & Jacobsen, B. H. (2020). *Virkemidler til reduktion af kvælstofbelastningen af vandmiljøet*. D. N. C. f. F. o. Jordbrug.
- Evans, C. D., Peacock, M., Baird, A. J., Artz, R. R. E., Burden, A., Callaghan, N., Chapman, P. J., Cooper, H. M., Coyle, M., Craig, E., Cumming, A., Dixon, S., Gauci, V., Grayson, R. P., Helfter, C., Heppell, C. M., Holden, J., Jones, D. L., Kaduk, J., Levy, P., Matthews, R., McNamara, N. P., Misselbrook, T., Oakley, S., Page, S. E., Rayment, M., Ridley, L. M., Stanley, K. M., Williamson, J. L., Worrall, F., & Morrison, R. (2021). Overriding water table control on managed peatland greenhouse gas emissions. *Nature*, 593(7860), 548-552. <https://doi.org/10.1038/s41586-021-03523-1>
- Flindt, M., Jørgensen, T., Petersen, J., & Stæhr, P. (2023). *Marine habitaters understøttelse af vigtige biologiske økosystemtjenester* (Videnskabelig rapport fra Nationalt Center for Marin Naturgenopretning, Issue.
- Fortuniak, K., Pawlak, W., Siedlecki, M., Chambers, S., & Bednorz, L. (2021). Temperate mire fluctuations from carbon sink to carbon source following changes in water table. *Science of The Total Environment*, 756, 144071. <https://doi.org/https://doi.org/10.1016/j.scitotenv.2020.144071>
- Frank-Gopolos, T., Nielsen, L., Skovmark, B. (2020). *Punktkilder 2020*. Miljøstyrelsen.
- Gasperi, J., Gromaire, M. C., Kafi, M., Moilleron, R., & Chebbo, G. (2010). Contributions of wastewater, runoff and sewer deposit erosion to wet weather pollutant loads in combined sewer systems. *Water Research*, 44(20), 5875-5886. <https://doi.org/https://doi.org/10.1016/j.watres.2010.07.008>
- Gyldenkærne, S., Greve, M. H. (2020). *Bestemmelse af drivhusgasemissionen fra lavbundsgrunde*.
- Hambäck, P. A., Dawson, L., Geranmayeh, P., Jarsjö, J., Kačergytė, I., Peacock, M., Collentine, D., Destouni, G., Futter, M., Hugelius, G., Hedman, S., Jonsson, S., Klatt, B. K., Lindström, A., Nilsson, J. E., Pärt, T., Schneider, L. D., Strand, J. A., Urrutia-Cordero, P., Åhlén, D., Åhlén, I., & Blicharska, M. (2023). Tradeoffs and synergies in wetland multifunctionality: A scaling issue. *Science of The Total Environment*, 862, 160746. <https://doi.org/https://doi.org/10.1016/j.scitotenv.2022.160746>
- Harpenslager, S. F., van den Elzen, E., Kox, M. A. R., Smolders, A. J. P., Ettwig, K. F., & Lamers, L. P. M. (2015). Rewetting former agricultural peatlands: Topsoil removal as a prerequisite to avoid strong nutrient and greenhouse gas emissions. *Ecological Engineering*, 84, 159-168. <https://doi.org/https://doi.org/10.1016/j.ecoleng.2015.08.002>
- Hauxwell, J., Cebrián, J., & Valiela, I. (2003). Eelgrass *Zostera marina* loss in temperate estuaries relationship to land-derived nitrogen loads and effect of light limitation imposed by algae. *Marine Ecology Progress Series*, 247, 59-73. <http://www.jstor.org/stable/24866447>
- Herbst, M., Friborg, T., Ringgaard, R., & Soegaard, H. (2011). Interpreting the variations in atmospheric methane fluxes observed above a restored wetland. *Agricultural and Forest Meteorology*, 151(7), 841-853. <https://doi.org/https://doi.org/10.1016/j.agrformet.2011.02.002>
- Herbst, M., Friborg, T., Schelde, K., Jensen, R., Ringgaard, R., Vasquez, V., Thomsen, A. G., & Soegaard, H. (2013). Climate and site management as driving factors for the atmospheric greenhouse gas exchange of a restored wetland. *Biogeosciences*, 10(1), 39-52. <https://doi.org/10.5194/bg-10-39-2013>
- Hoffmann, C. C., & Baattrup-Pedersen, A. (2007). Re-establishing freshwater wetlands in Denmark. *Ecological Engineering*, 30(2), 157-166.
- Hoffmann, C. C., Larsen, S. E., & Kjaergaard, C. (2019). Nitrogen Removal in Woodchip - based Biofilters of Variable Designs Treating Agricultural Drainage Discharges. *Journal of Environmental Quality*, 48(6), 1881-1889.

- Hoffmann, C. C., Zak, D., Kronvang, B., Kjaergaard, C., Carstensen, M. V., & Audet, J. (2020). An overview of nutrient transport mitigation measures for improvement of water quality in Denmark. *Ecological Engineering*, 155, 105863.
- Huth, V., Günther, A., Bartel, A., Hofer, B., Jacobs, O., Jantz, N., Meister, M., Rosinski, E., Urich, T., Weil, M., Zak, D., & Jurasinski, G. (2020). Topsoil removal reduced in-situ methane emissions in a temperate rewetted bog grassland by a hundredfold. *Science of The Total Environment*, 721, 137763. <https://doi.org/https://doi.org/10.1016/j.scitotenv.2020.137763>
- Hvitved-Jacobsen, T., Vollertsen, J., & Nielsen, A. H. (2010). *Urban and highway stormwater pollution: concepts and engineering*. CRC press.
- Indris, S. N., Rudolph, D. L., Glass, B. K., & Cappellen, P. V. (2020). Evaluating phosphorous from vehicular emissions as a potential source of contamination to ground and surface water. *Cogent Environmental Science*, 6(1), 1794702. <https://doi.org/10.1080/23311843.2020.1794702>
- IPCC. (2014). *Climate Change 2013 – The Physical Science Basis: Working Group I Contribution to the Fifth Assessment Report of the Intergovernmental Panel on Climate Change*. Cambridge University Press. <https://doi.org/DOI:10.1017/CBO9781107415324>
- Istenič, D., Arias, C. A., Vollertsen, J., Nielsen, A. H., Wium-Andersen, T., Hvitved-Jacobsen, T., & Brix, H. (2012). Improved urban stormwater treatment and pollutant removal pathways in amended wet detention ponds. *Journal of Environmental Science and Health, Part A*, 47(10), 1466-1477. <https://doi.org/10.1080/10934529.2012.673306>
- Janke, B. D., Finlay, J. C., Taguchi, V. J., & Gulliver, J. S. (2022). Hydrologic processes regulate nutrient retention in stormwater detention ponds. *Science of The Total Environment*, 823, 153722. <https://doi.org/https://doi.org/10.1016/j.scitotenv.2022.153722>
- Jaynes, D. B., & Isenhardt, T. M. (2018). Performance of Saturated Riparian Buffers in Iowa, USA [<https://doi.org/10.2134/jeq2018.03.0115>]. *Journal of Environmental Quality*, 48(2), 289-296. <https://doi.org/https://doi.org/10.2134/jeq2018.03.0115>
- Jégliot, A., Sørensen, S. R., Schnorr, K. M., Plauborg, F., & Elsgaard, L. (2021). Temperature Sensitivity and Composition of Nitrate-Reducing Microbiomes from a Full-Scale Woodchip Bioreactor Treating Agricultural Drainage Water. *Microorganisms*, 9(6).
- Kandel, T. P., Karki, S., Elsgaard, L., Labouriau, R., & Lærke, P. E. (2020). Methane fluxes from a rewetted agricultural fen during two initial years of paludiculture. *Science of The Total Environment*, 713, 136670. <https://doi.org/https://doi.org/10.1016/j.scitotenv.2020.136670>
- Kandel, T. P., Lærke, P. E., Hoffmann, C. C., & Elsgaard, L. (2019). Complete annual CO₂, CH₄, and N₂O balance of a temperate riparian wetland 12 years after rewetting. *Ecological Engineering*, 127, 527-535. <https://doi.org/https://doi.org/10.1016/j.ecoleng.2017.12.019>
- Kasak, K., Kill, K., Uemaa, E., Maddison, M., Aunap, R., Riibak, K., Okiti, I., Teemusk, A., & Mander, Ü. (2022). Low water level drives high nitrous oxide emissions from treatment wetland. *Journal of Environmental Management*, 312, 114914. <https://doi.org/https://doi.org/10.1016/j.jenvman.2022.114914>
- Kavehei, E., Jenkins, G. A., Adame, M. F., & Lemckert, C. (2018). Carbon sequestration potential for mitigating the carbon footprint of green stormwater infrastructure. *Renewable and Sustainable Energy Reviews*, 94, 1179-1191. <https://doi.org/https://doi.org/10.1016/j.rser.2018.07.002>
- Keddy, P. A. (2010). *Wetland ecology: principles and conservation*. Cambridge university press.
- Kieckbusch, J. J., & Schrautzer, J. (2007). Nitrogen and phosphorus dynamics of a re-wetted shallow-flooded peatland. *Science of The Total Environment*, 380(1), 3-12. <https://doi.org/https://doi.org/10.1016/j.scitotenv.2006.10.002>

- Koch, B. J., Febria, C. M., Gevrey, M., Wainger, L. A., & Palmer, M. A. (2014). Nitrogen Removal by Stormwater Management Structures: A Data Synthesis [<https://doi.org/10.1111/jawr.12223>]. *JAWRA Journal of the American Water Resources Association*, 50(6), 1594-1607. <https://doi.org/https://doi.org/10.1111/jawr.12223>
- Kronvang, B., Andersen, I. K., Hoffmann, C. C., Pedersen, M. L., Ovesen, N. B., & Andersen, H. E. (2007). Water Exchange and Deposition of Sediment and Phosphorus during Inundation of Natural and Restored Lowland Floodplains. *Water, Air, and Soil Pollution*, 181(1), 115-121. <https://doi.org/10.1007/s11270-006-9283-y>
- Kynkäänniemi, P., Ulén, B., Torstensson, G., & Tonderski, K. S. (2013). Phosphorus Retention in a Newly Constructed Wetland Receiving Agricultural Tile Drainage Water. *Journal of Environmental Quality*, 42(2), 596-605. <https://doi.org/https://doi.org/10.2134/jeq2012.0266>
- Lavrić, S., Nan, X., Blasioli, S., Braschi, I., Anconelli, S., & Toscano, A. (2020). Performance of a full scale constructed wetland as ecological practice for agricultural drainage water treatment in Northern Italy. *Ecological Engineering*, 154, 105927. <https://doi.org/https://doi.org/10.1016/j.ecoleng.2020.105927>
- Li, X., Wahlroos, O., Haapanala, S., Pumpanen, J., Vasander, H., Ojala, A., Vesala, T., & Mammarella, I. (2020). Carbon dioxide and methane fluxes from different surface types in a created urban wetland. *Biogeosciences*, 17(13), 3409-3425. <https://doi.org/10.5194/bg-17-3409-2020>
- Mander, Ü., Tournebize, J., Espenberg, M., Chaumont, C., Torga, R., Garnier, J., Muhel, M., Maddison, M., Lebrun, J. D., Uher, E., Remm, K., Pärn, J., & Soosaar, K. (2021). High denitrification potential but low nitrous oxide emission in a constructed wetland treating nitrate-polluted agricultural run-off. *Science of The Total Environment*, 779, 146614. <https://doi.org/https://doi.org/10.1016/j.scitotenv.2021.146614>
- McLeod, E., Chmura, G. L., Bouillon, S., Salm, R., Björk, M., Duarte, C. M., Lovelock, C. E., Schlesinger, W. H., & Silliman, B. R. (2011). A blueprint for blue carbon: toward an improved understanding of the role of vegetated coastal habitats in sequestering CO₂. *Frontiers in Ecology and the Environment*, 9(10), 552-560. <https://doi.org/https://doi.org/10.1890/110004>
- Mendes, D., & Renato, L. (2020). Edge-of-Field Technologies for Phosphorus Retention from Agricultural Drainage Discharge. *Applied Sciences*, 10(2), 634. <https://www.mdpi.com/2076-3417/10/2/634>
- Mendes, L. R. (2021). Nitrogen Removal from Agricultural Subsurface Drainage by Surface-Flow Wetlands: Variability. *Processes*, 9(1).
- Mendes, L. R. D., Tonderski, K., Iversen, B. V., & Kjaergaard, C. (2018). Phosphorus retention in surface-flow constructed wetlands targeting agricultural drainage water. *Ecological Engineering*, 120, 94-103. <https://doi.org/https://doi.org/10.1016/j.ecoleng.2018.05.022>
- Merriman, L. S., Moore, T. L. C., Wang, J. W., Osmond, D. L., Al-Rubaei, A. M., Smolek, A. P., Blecken, G. T., Viklander, M., & Hunt, W. F. (2017). Evaluation of factors affecting soil carbon sequestration services of stormwater wet retention ponds in varying climate zones. *Science of The Total Environment*, 583, 133-141. <https://doi.org/https://doi.org/10.1016/j.scitotenv.2017.01.040>
- Moore, T. L. C., & Hunt, W. F. (2012). Ecosystem service provision by stormwater wetlands and ponds – A means for evaluation? *Water Research*, 46(20), 6811-6823. <https://doi.org/https://doi.org/10.1016/j.watres.2011.11.026>
- Mrotzek, A., Michaelis, D., Günther, A., Wrage-Mönnig, N., & Couwenberg, J. (2020). Mass Balances of a Drained and a Rewetted Peatland: on Former Losses and Recent Gains. *Soil Systems*, 4(1), 16. <https://www.mdpi.com/2571-8789/4/1/16>

- Møller, A. B., Børgesen, C. D., Bach, E. O., Iversen, B. V., & Moeslund, B. (2018). Kortlægning af drænedede arealer i Danmark. *DCA – Nationalt Center for Fødevarer og Jordbrug*.
- Parfitt, R. L., Atkinson, R. J., & Smart, R. S. C. (1975). The Mechanism of Phosphate Fixation by Iron Oxides. *Soil Science Society of America Journal*, 39(5), 837-841. <https://doi.org/https://doi.org/10.2136/sssaj1975.03615995003900050017x>
- Peacock, M., Audet, J., Jordan, S., Smeds, J., & Wallin, M. B. (2019). Greenhouse gas emissions from urban ponds are driven by nutrient status and hydrology. *Ecosphere*, 10(3), e02643. <https://doi.org/https://doi.org/10.1002/ecs2.2643>
- Petersen, S. G. G., Kristensen, E., & Quintana, C. O. (2022). Greenhouse gas emissions from agricultural land before and after permanent flooding with seawater or freshwater [Manuscript submitted for publication]. Department of Biology, University of Southern Denmark. In.
- Plauborg, F., Skjødt, M. H., Audet, J., Hoffmann, C. C., & Jacobsen, B. H. (2023). Cost effectiveness, nitrogen, and phosphorus removal in field-based woodchip bioreactors treating agricultural drainage water. *Environmental Monitoring and Assessment*, 195(7), 849. <https://doi.org/10.1007/s10661-023-11358-8>
- Ranalli, A. J., & Macalady, D. L. (2010). The importance of the riparian zone and in-stream processes in nitrate attenuation in undisturbed and agricultural watersheds – A review of the scientific literature. *Journal of Hydrology*, 389(3), 406-415. <https://doi.org/https://doi.org/10.1016/j.jhydrol.2010.05.045>
- Rodríguez, R. A., Gundy, P. M., Rijal, G. K., & Gerba, C. P. (2012). The Impact of Combined Sewage Overflows on the Viral Contamination of Receiving Waters. *Food and Environmental Virology*, 4(1), 34-40. <https://doi.org/10.1007/s12560-011-9076-3>
- Rout, P. R., Shahid, M. K., Dash, R. R., Bhunia, P., Liu, D., Varjani, S., Zhang, T. C., & Surampalli, R. Y. (2021). Nutrient removal from domestic wastewater: A comprehensive review on conventional and advanced technologies. *Journal of Environmental Management*, 296, 113246. <https://doi.org/https://doi.org/10.1016/j.jenvman.2021.113246>
- Schrier-Uijl, A. P., Kroon, P. S., Hendriks, D. M. D., Hensen, A., Van Huissteden, J., Berendse, F., & Veenendaal, E. M. (2014). Agricultural peatlands: towards a greenhouse gas sink – a synthesis of a Dutch landscape study. *Biogeosciences*, 11(16), 4559-4576. <https://doi.org/10.5194/bg-11-4559-2014>
- Schroer, W. F., Benitez-Nelson, C. R., Smith, E. M., & Ziolkowski, L. A. (2018). Drivers of Sediment Accumulation and Nutrient Burial in Coastal Stormwater Detention Ponds, South Carolina, USA. *Ecosystems*, 21(6), 1118-1138. <https://doi.org/10.1007/s10021-017-0207-z>
- Schwieger, S., Kreyling, J., Couwenberg, J., Smiljanić, M., Weigel, R., Wilmking, M., & Blume-Werry, G. (2021). Wetter is better: Rewetting of minerotrophic peatlands increases plant production and moves them towards carbon sinks in a dry year. *Ecosystems*, 24(5), 1093-1109.
- Short, F. T., & Burdick, D. M. (1996). Quantifying eelgrass habitat loss in relation to housing development and nitrogen loading in Waquoit Bay, Massachusetts. *Estuaries*, 19(3), 730-739. <https://doi.org/10.2307/1352532>
- Stadmark, J., & Leonardson, L. (2005). Emissions of greenhouse gases from ponds constructed for nitrogen removal. *Ecological Engineering*, 25(5), 542-551. <https://doi.org/https://doi.org/10.1016/j.ecoleng.2005.07.004>
- Steidl, J., Kalettka, T., & Bauwe, A. (2019). Nitrogen retention efficiency of a surface-flow constructed wetland receiving tile drainage water: A case study from north-eastern Germany. *Agriculture, Ecosystems & Environment*, 283, 106577. <https://doi.org/https://doi.org/10.1016/j.agee.2019.106577>

- Sukias, J., & Tanner, C. (2011). Surface flow constructed wetlands as a drainage management tool—long term performance. *Adding to the Knowledge Base for the Nutrient Manager, Fertilizer & Lime Research Centre, Occasional Report No, 24*.
- Sønderup, M. J., Egemose, S., Hansen, A. S., Grudinina, A., Madsen, M. H., & Flindt, M. R. (2016). Factors affecting retention of nutrients and organic matter in stormwater ponds. *Ecohydrology*, 9(5), 796-806. <https://doi.org/10.1002/eco.1683>
- Søvik, A., Augustin, J., Heikkinen, K., Huttunen, J., Necki, J., Karjalainen, S., Kløve, B., Liikanen, A., Mander, Ü., & Puustinen, M. (2006). Emission of the greenhouse gases nitrous oxide and methane from constructed wetlands in Europe. *Journal of Environmental Quality*, 35(6), 2360-2373.
- Taillardat, P., Thompson, B. S., Garneau, M., Trottier, K., & Friess, D. A. (2020). Climate change mitigation potential of wetlands and the cost-effectiveness of their restoration. *Interface Focus*, 10(5), 20190129.
- Tiemeyer, B., Albiac Borraz, E., Augustin, J., Bechtold, M., Beetz, S., Beyer, C., Drösler, M., Ebli, M., Eickenscheidt, T., Fiedler, S., Förster, C., Freibauer, A., Giebels, M., Glatzel, S., Heinichen, J., Hoffmann, M., Höper, H., Jurasinski, G., Leiber-Sauheitl, K., Peichl-Brak, M., Roßkopf, N., Sommer, M., & Zeitz, J. (2016). High emissions of greenhouse gases from grasslands on peat and other organic soils. *Global Change Biology*, 22(12), 4134-4149. <https://doi.org/10.1111/gcb.13303>
- Tiemeyer, B., Freibauer, A., Borraz, E. A., Augustin, J., Bechtold, M., Beetz, S., Beyer, C., Ebli, M., Eickenscheidt, T., Fiedler, S., Förster, C., Gensior, A., Giebels, M., Glatzel, S., Heinichen, J., Hoffmann, M., Höper, H., Jurasinski, G., Laggner, A., Leiber-Sauheitl, K., Peichl-Brak, M., & Drösler, M. (2020). A new methodology for organic soils in national greenhouse gas inventories: Data synthesis, derivation and application. *Ecological Indicators*, 109, 105838. <https://doi.org/10.1016/j.ecolind.2019.105838>
- Tolomio, M., Dal Ferro, N., & Borin, M. (2019). Multi-Year N and P Removal of a 10-Year-Old Surface Flow Constructed Wetland Treating Agricultural Drainage Waters. *Agronomy*, 9(4).
- Troitsky, B., Zhu, D. Z., Loewen, M., van Duin, B., & Mahmood, K. (2019). Nutrient processes and modeling in urban stormwater ponds and constructed wetlands. *Canadian Water Resources Journal / Revue canadienne des ressources hydriques*, 44(3), 230-247. <https://doi.org/10.1080/07011784.2019.1594390>
- Ulén, B., Geranmayeh, P., Blomberg, M., & Bieroza, M. (2019). Seasonal variation in nutrient retention in a free water surface constructed wetland monitored with flow-proportional sampling and optical sensors. *Ecological Engineering*, 139, 105588. <https://doi.org/10.1016/j.ecoleng.2019.105588>
- Valdemarsen, T., Canal-Vergés, P., Kristensen, E., Holmer, M., Kristiansen, M. D., & Flindt, M. (2010). Vulnerability of *Zostera marina* seedlings to physical stress. *Marine Ecology Progress Series*, 418, 119-130.
- van Bergen, T. J. H. M., Barros, N., Mendonça, R., Aben, R. C. H., Althuizen, I. H. J., Huszar, V., Lamers, L. P. M., Lürling, M., Roland, F., & Kosten, S. (2019). Seasonal and diel variation in greenhouse gas emissions from an urban pond and its major drivers. *Limnology and Oceanography*, 64(5), 2129-2139. <https://doi.org/10.1002/lno.11173>
- Villa, J. A., & Bernal, B. (2018). Carbon sequestration in wetlands, from science to practice: An overview of the biogeochemical process, measurement methods, and policy framework. *Ecological Engineering*, 114, 115-128. <https://doi.org/10.1016/j.ecoleng.2017.06.037>

- Vymazal, J. (2007). Removal of nutrients in various types of constructed wetlands. *Science of The Total Environment*, 380(1), 48-65. <https://doi.org/https://doi.org/10.1016/j.scitotenv.2006.09.014>
- Vymazal, J. (2017). The use of constructed wetlands for nitrogen removal from agricultural drainage: A review. *Scientia agriculturae bohemica*, 48(2), 82-91.
- Vymazal, J., Sochacki, A., Fučík, P., Šereš, M., Kaplická, M., Hnátková, T., & Chen, Z. (2020). Constructed wetlands with subsurface flow for nitrogen removal from tile drainage. *Ecological Engineering*, 155, 105943. <https://doi.org/https://doi.org/10.1016/j.ecoleng.2020.105943>
- Walsh, C. J., Roy, A. H., Feminella, J. W., Cottingham, P. D., Groffman, P. M., & Morgan, R. P. (2005). The urban stream syndrome: current knowledge and the search for a cure. *Journal of the North American Benthological Society*, 24(3), 706-723. <https://doi.org/10.1899/04-028.1>
- Walton, C. R., Zak, D., Audet, J., Petersen, R. J., Lange, J., Oehmke, C., Wichtmann, W., Kreyling, J., Grygoruk, M., Jabłońska, E., Kotowski, W., Wiśniewska, M. M., Ziegler, R., & Hoffmann, C. C. (2020). Wetland buffer zones for nitrogen and phosphorus retention: Impacts of soil type, hydrology and vegetation. *Science of The Total Environment*, 727, 138709. <https://doi.org/https://doi.org/10.1016/j.scitotenv.2020.138709>
- Were, D., Kansime, F., Fetahi, T., Cooper, A., & Jjuuko, C. (2019). Carbon Sequestration by Wetlands: A Critical Review of Enhancement Measures for Climate Change Mitigation. *Earth Systems and Environment*, 3(2), 327-340. <https://doi.org/10.1007/s41748-019-00094-0>
- Wesström, I., & Messing, I. (2007). Effects of controlled drainage on N and P losses and N dynamics in a loamy sand with spring crops. *Agricultural Water Management*, 87(3), 229-240. <https://doi.org/https://doi.org/10.1016/j.agwat.2006.07.005>
- Wilson, D., Blain, D., Couwenberg, J., Evans, C. D., Murdiyarto, D., Page, S. E., Renou-Wilson, F., Rieley, J. O., Strack, M., & Tuittila, E. S. (2016). Greenhouse gas emission factors associated with rewetting of organic soils. <http://hdl.handle.net/10012/11532>
- Wilson, D., Mackin, F., Tuovinen, J.-P., Moser, G., Farrell, C., & Renou-Wilson, F. (2022). Carbon and climate implications of rewetting a raised bog in Ireland. *Global Change Biology*, 28(21), 6349-6365. <https://doi.org/https://doi.org/10.1111/gcb.16359>
- Zak, D., Kronvang, B., Carstensen, M. V., Hoffmann, C. C., Kjeldgaard, A., Larsen, S. E., Audet, J., Egemose, S., Jorgensen, C. A., & Feuerbach, P. (2018). Nitrogen and phosphorus removal from agricultural runoff in integrated buffer zones. *Environmental science & technology*, 52(11), 6508-6517.
- Zak, D., Stutter, M., Jensen, H. S., Egemose, S., Carstensen, M. V., Audet, J., Strand, J. A., Feuerbach, P., Hoffmann, C. C., & Christen, B. (2019). An assessment of the multifunctionality of integrated buffer zones in Northwestern Europe. *Journal of Environmental Quality*, 48(2), 362-375.
- Zarnoch, C. B., Hoellein, T. J., Furman, B. T., & Peterson, B. J. (2017). Eelgrass meadows, *Zostera marina* (L.), facilitate the ecosystem service of nitrogen removal during simulated nutrient pulses in Shinnecock Bay, New York, USA. *Marine Pollution Bulletin*, 124(1), 376-387. <https://doi.org/https://doi.org/10.1016/j.marpolbul.2017.07.061>
- Zhai, X., Piwpuan, N., Arias, C. A., Headley, T., & Brix, H. (2013). Can root exudates from emergent wetland plants fuel denitrification in subsurface flow constructed wetland systems? *Ecological Engineering*, 61, 555-563. <https://doi.org/https://doi.org/10.1016/j.ecoleng.2013.02.014>

Appendix

Supplement table 1 – The greenhouse gas emissions from the studies on the measures included in this review, summarizing carbon dioxide, methane, and nitrous oxide as well as the GWP potential including them all. Sources and n present in table 2.

Measure	CO ₂	CH ₄	N ₂ O		GWP	
	kg CO ₂ -C-eq ha ⁻¹ yr ⁻¹	kg C ha ⁻¹ yr ⁻¹	kg CO ₂ -C-eq ha ⁻¹ yr ⁻¹	kg N ha ⁻¹ yr ⁻¹	kg CO ₂ -C-eq ha ⁻¹ yr ⁻¹	kg CO ₂ -C-eq ha ⁻¹ yr ⁻¹
SF-CW	2573±1101	167±35	1706±358	2.58±0.60	605±141	4884±1166
SSF-CW	17093±7591	6297±4075	64257±41584	0.00±0.10	0.0±23.9	81351±42271
Wetlands	-2993±6201	126±142	1286±1444	1.26±0.73	296±172	-1411±6370
Lowland soil	-2776±4576	195±229	1993±2339	1.08±1.09	254±256	-528±5145
Stormwater pond (wet)	1430±1408	135±170	1382±1733	0.69±2.30	162±538	2974±2297

Vurdering af tidlig virkemiddeleffekt (AP 4.2)

The potential for constructed subsurface mini wetlands in the catchment of Odense Fjord. Technical note.

Author: Majken Meldorf Deichmann, SEGES Innovation,

Cite: Deichmann M M, 2023. The potential for constructed subsurface mini wetlands in the catchment of Odense Fjord. Technical note from SEGES Innovation.

Resume

Der er foreslået etablering af 127 minivådområder i oplandet til Odense Fjord. Placeringen af minivådområderne er baseret på brug af værktøjet Scalgo vedrørende overfladevandets strømningsveje, kombineret med det officielle kort for potentiel placering af minivådområder. Outputdata fra den indledende analyse for steder til etablering af minivådområder blev derefter filtreret baseret på følgende betingelser; områder udpeget som ådale eller i det direkte drænopland til ådale fra sorteres, mindst 80% af oplandet til et minivådområde skal være dyrket landbrugsarealer, og oplandet til et minivådområde skal være mindst 20 ha. Den potentielle kvælstoffjernelse i minivådområder blev estimeret under følgende antagelser: størrelsen af et minivådområde svarer til 1% af minivådområdets opland, og et minivådområde har en årlig effekt på 472 kg N/ha minivådområde-vandflade. Data fra Aarhus Universitets NLES5-model og GEUS's DK-model er blevet brugt til at estimere den samlede N-belastning fra hver ID15-opfangsområde inden for oplandet til Odense Fjord. En opdelt nøgle leveret af Aarhus Universitet og produceret med DAISY-modellen, blev brugt til at bestemme, hvordan det årlige N-tab beregnet med NLES5-modellen er fordelt månedligt. Den samme opdelt nøgle blev brugt til at bestemme den månedlige N-effekt af minivådområder. Baseret på GIS-analysen blev hvert minivådområde placeret inden for et ID15-opland. Analysen viste, at etableringen af de 127 mini-vådområder kunne reducere det årlige N-tab fra oplandet med 44 tons. Månedsfordeling fremgår af tabel 4.

The potential for constructed subsurface mini wetlands in the catchment of Odense Fjord

Currently, an assessment of the retention potential in the catchment of Odense Fjord is ongoing. As part of this progress, SEGES Innovation has analyzed the prospective of constructed subsurface mini wetlands in the catchment. The following data has been utilized to determine the possible placements of mini wetlands:

- The official government map for the potential placement of mini wetlands
- SEGES Innovations map layer *Green Crossing* which is developed by Scalgo.

The map layer *Green Crossings* identifies areas, which could be suitable for the establishment of a mini wetland. The layer is based on a national mapping of flow pathways, and the following criteria have been applied in the analysis:

- All streams and rivers have been modeled to be at sea level. This is done to ensure that a flow pathway can return to ground level in flat areas. There are some uncertainties, especially at road underpasses which are considered a barrier.
- There is placed a point at each flow pathway 10 meters before the pathway leaves the field. This is done based on SEGES Innovations internal Field layer (GIS layer containing all agricultural fields in Denmark). This buffer 10 meters before the edge of the field serves to minimize the number of flow pathways that leave trenches in flat terrain and serves to lower the number of false locations for mini wetlands.
- Flow pathways entering depressions are in some cases miscalculated, while pathways through landscapes below sea level consistently are miscalculated.
- There are designated up to 6 potential locations suitable for mini wetlands along a single flow pathway. The use of any of these locations automatically leads to an elimination of the remaining locations, as the Danish regulation states that subsidies can only be allocated once for the decontamination of nutrients from drainage water.

It is important to note that the *Green Crossing* analysis may skip some areas suitable for the establishment of mini wetlands. Likewise, some areas might appear suitable at first glance but might not be realizable due to other interests in the area. This is largely caused by the fact that the analysis is based on the terrain flow of water and thus neglects to consider the actual drainage conditions in the area. Hence the drainage system can be both larger and smaller than the run of area estimated by the model. Additionally, this also means that the map can show potential locations for mini wetlands in areas where there is no tile drainage. estimated

In the analysis of potential locations for mini wetlands in the catchment of Odense Fjord, only the most downstream location along a flow pathway has been applied. This ensures that the analysis estimates the maximum nitrate retention potential for the mini wetlands.

In addition, the following criteria have been applied for the mapping of potential mini wetlands locations in the Odense Fjord catchment:

- Areas appointed as river valleys or direct catchments to river valleys in the official government map for the potential placement of mini wetlands are passed over.
- At least 80% of the catchment area to a mini wetland must be active agricultural fields.
- The catchment area of a mini wetland must be at least 20 ha.

The analysis does not consider other potential interests in the areas such as urban development, and nature conservation among others. Particularly the nature protection zones could hinder the establishment of a mini wetland, but in many of the locations, it will be possible to establish the mini wetland a bit further upstream, ensuring that the project area does not intersect with potential nature protection zones.

The potential effect of the mini wetlands is calculated at the ID15 catchment scale (a sub-division of Denmark into a catchment resolution of approximately 1500 ha). However, the results are only

presented for the entire Odense Fjord catchment and at the sub-level for “farvand 4” catchments. Odense Fjord catchment consists of three “farvand 4” catchments (4231, 4232, 4233) which can be seen in Figure 1.

The placement analysis for mini wetlands in the Odense Fjord Catchment indicates that there are 127 potential locations suitable for the establishment of a mini wetland (Figure 1).

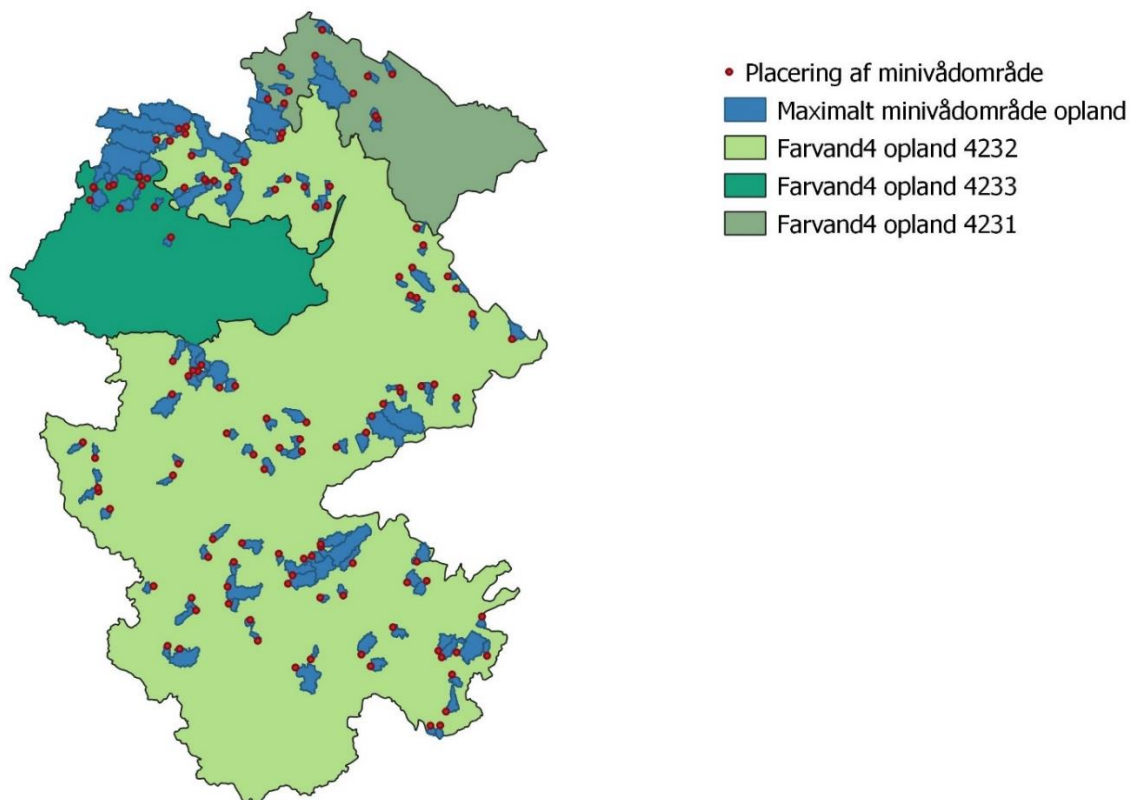

Figure 14: Overview of “farvand 4” oplande and the potential mini wetland’s locations (red dots) across the Odense Fjord catchment. Blue areas indicate the catchment area for each mini wetland.

Based on the catchment area of each mini wetland SEGES Innovation has calculated the potential N-retention effect of each mini wetland. This calculation is based on the following assumptions:

- The size of a mini wetland equals 1% of the mini wetland’s catchment area.
- A mini wetland has an annual effect of 472 kg N/ha mini wetland area ¹.

The annual effect of the mini wetlands is calculated based on equation 1:

$$(1) \text{ Mini wetland effect}_{stream\ edge} (kg\ N/\text{\AA}r) = \text{mini wetland area (ha)} * 472\ kg\ N/\text{ha}/\text{\AA}r$$

Table 1 shows an overview of the annual maximum retention potential for the mini wetlands in the Odense Fjord Catchment:

Table 6: Distribution of mini wetlands in each of the tree “farvand 4” catchments in the Odense Fjord catchment and the maximum annual N-retention that the mini wetlands can obtain if all 127 mini wetlands are established.

Catchment	Number of mini wetlands	Effect (tons N pr. year)
All of Odense Fjord catchment	127	50,79
4231	11	3,95
4232	104	42,07
4233	12	4,76

It should be noted that Table 1 only shows the reduction potential for the mini wetlands. Thus, the numbers do not show the actual N-loss to the stream edge but only how much the N-loss at the stream edge can be reduced by the establishment of the mini wetlands.

Furthermore, SEGES Innovation has calculated the effect that the establishment of the mini wetlands will have on the Odense estuary. This calculation is based on data from Aarhus University’s NLES5 model. The NLES5 data provided by Aarhus University gives an estimate of the monthly N-leaching out of the root zone for each ID15 catchment. The NLES5 model provides data on an annual scale and consequently, Aarhus University has used the DAISY model from Copenhagen University to split the root zone leaching to a monthly time unit. The data from Aarhus University is calculated based on input data from the period 1990-2010, and the numbers indicate average values. Besides the data concerning N-leaching from the root zone, data regarding the average surface retention in each ID15 catchment has also been provided by Aarhus University

Additional data related to the drainage fractions in each of the ID15 catchments has been provided from GESUS DK-Model. These numbers indicate the average drainage fraction on a monthly scale for the period 1990-2010.

The total monthly N-transport from each ID15 catchment to Odense Fjord had been calculated based on the data provided by Aarhus University and GEUS. This calculation assumes the existence of no retention-enhancing mitigation tools in the catchments (mini wetlands, wetlands, intelligent buffer zones, and so on.). The total N-loss from the Odense Fjord catchment to the estuary can be seen in Table 2.

Table 7: Calculated monthly average N-loss from the Odense Fjord catchment to the estuary for the period 1990-2010, when assuming that there has not been established any retention enhancing mitigation tools in the catchment.

Month	All of Odense Fjord catchment (tons N)	4231 (tons N)	4232 (tons N)	4233 (tons N)
January	269,41	14,53	224,66	30,22
Febuary	136,13	8,11	112,55	15,47
Mach	81,01	5,15	66,24	9,59
April	33,20	1,59	27,53	4,08
May	16,09	0,66	13,71	1,72
June	15,13	0,60	12,94	1,59

July	15,48	0,64	13,21	1,63
August	16,63	0,67	14,10	1,87
September	23,09	0,94	19,39	2,75
October	59,99	2,80	48,70	7,49
November	181,68	8,60	151,20	21,89
December	259,52	13,57	216,42	29,63
All year	1106,47	57,90	920,64	127,93

Note that the N-loss calculated in this analysis only relates to N-loss from nature and agricultural land. This makes it difficult to directly compare the number in Table 2 and the values from VP3 since the baseline scenario for VP3 also includes N-loss from wastewater. It should also be noted the data used for the development of VP3 originates from another period compared to the one used for this analysis.

Figure 2 and 3 shows the annual N-loss from Table 2 for each ID15 catchment in the Odense Fjord catchment divided into half-annual N-losses for the summer (April- September) and winter (October-March) months.

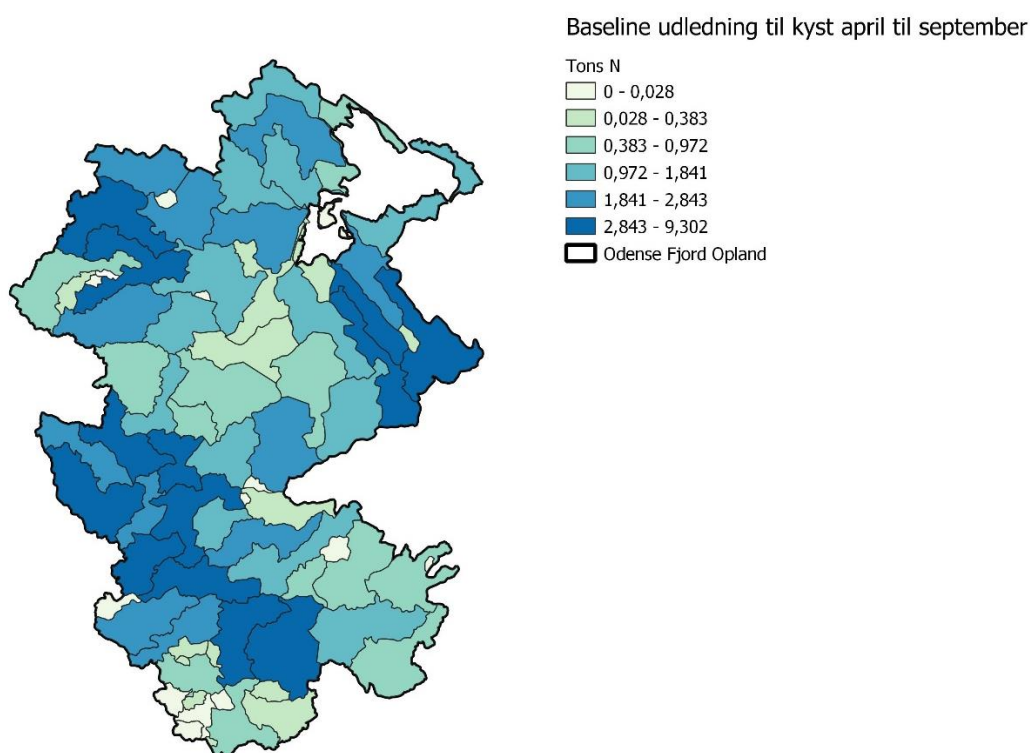

Figure 15: Calculated half-annual (April-September) N-loss from the Odense Fjord catchment to the estuary for each ID15 catchment during the period 1990-2010, when assuming that there has not been established any retention enhancing mitigation tools in the catchment.

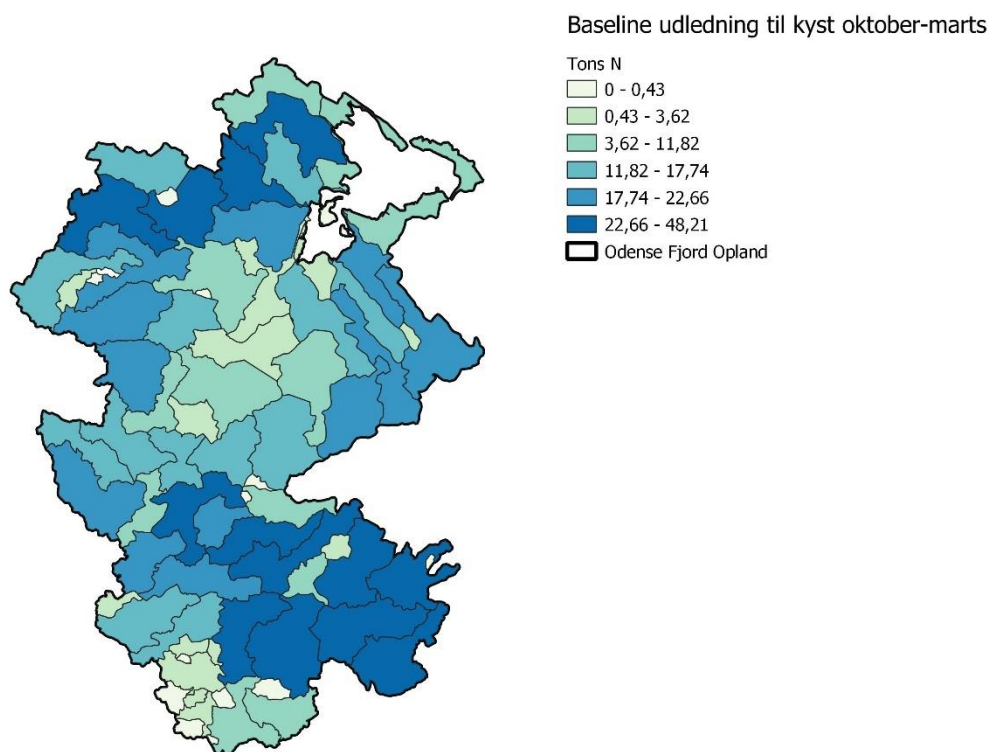

Figure 16: Calculated half-annual (October-March) N-loss from the Odense Fjord catchment to the estuary for each ID15 catchment during the period 1990-2010, when assuming that there has not been established any retention enhancing mitigation tools in the catchment.

A comparison between Figures 2 and 3 shows that there is a higher N-loss from Odense Fjord Catchment during the winter months (October- March) compared to the summer months (April- September). Furthermore, the comparison highlights that the primary N-loss originates from different ID15 catchments depending on the season. This is likely caused by differences related to soil type, drainage fractions, and surface retention between the different ID15 catchments. Thus, an ID15 catchment with clay soil and a high fraction of drainage might have a low N-loss during the summer when there is little transport of N through the drains, while it might have a high N-loss during winter when lots of water is transported through the drains. Likewise, a sandy ID15 catchment could appear to have a high N-loss during the summer as water is transported continuously through the soil all year. However, during the winter this transportation might appear small compared to the transportation of N through drains in the clay catchments.

SEGES Innovation has calculated how much the N-loss could be reduced if the 127 mini wetlands from Figure 1 are established in the Odense Fjord catchments.

This calculation is based on several sub-calculations:

Determination of the monthly effect of the mini wetlands until the stream edge. This is based on the same split key as Aarhus University used to split the annual N-loss from the root zone.

Summation of the mini wetlands monthly effect at ID15 catchment scale.

Calculation of the monthly N-loss through drains until the stream edge when the effect of the mini wetlands is deducted for each ID15 catchment.

Calculation of the monthly groundwater N-loss until the stream edge for each ID15 catchment

Calculation of the total monthly N-loss until the stream edge for each ID15 catchment (drainage N-loss when the effect of mini wetlands is deducted + groundwater N-loss).

Calculate the total monthly N-loss to the estuary for each ID15 catchment (drainage N-loss when the effect of mini wetlands is deducted + groundwater N-loss) by multiplying the N-loss at the river edge by the surface retention.

Following steps 1-6 SEGES Innovations has calculated how much the monthly N-loss to the estuary is if the 127 mini wetlands are established. The results can be seen in Table 3.

Table 8: Calculated N-loss from the Odense Fjord catchment to the estuary if the 127 mini wetlands shown in Figure 1 are established.

Month	All of Odense Fjord catchment (tons N)	4231 (tons N)	4232 (tons N)	4233 (tons N)
January	259,87	14,03	216,15	29,68
February	129,50	7,74	106,70	15,06
March	76,49	4,91	62,25	9,32
April	31,06	1,47	25,62	3,98
May	15,06	0,61	12,79	1,66
June	14,78	0,58	12,63	1,57
July	14,92	0,61	12,71	1,59
August	16,14	0,64	13,64	1,85
September	21,69	0,87	18,13	2,70
October	55,45	2,60	45,46	7,39
November	175,66	8,26	145,67	22,13
December	251,90	13,16	209,47	29,26
All year	1063,21	55,48	881,23	125,80

A comparison of the numbers in Tables 2 and 3 shows that the establishment of the 127 mini wetlands has the potential to reduce the annual N-loss of the Odense Fjord by approximately 44 tons. This is less than the 51 tons previously indicated in Table 1. This is a consequence of the fact that the calculated reduction potential of mini wetlands (see equation 1) in some ID15 catchments is higher than the actual amount of N-leached through the drains. However, since it is impossible to have a negative N-loss, the net loss of N through these mini wetlands has been set to 0 in the final calculation of the mini wetlands' N-loss to the estuary.

Figures 4 and 5 show the half-annual N-loss from the Odense Fjord catchment to the estuary for each ID15 catchment when the 127 mini wetlands are established. Figure 4 shows the N-loss during the summer (April-September) while figure 5 shows the N-loss during the winter (October-March).

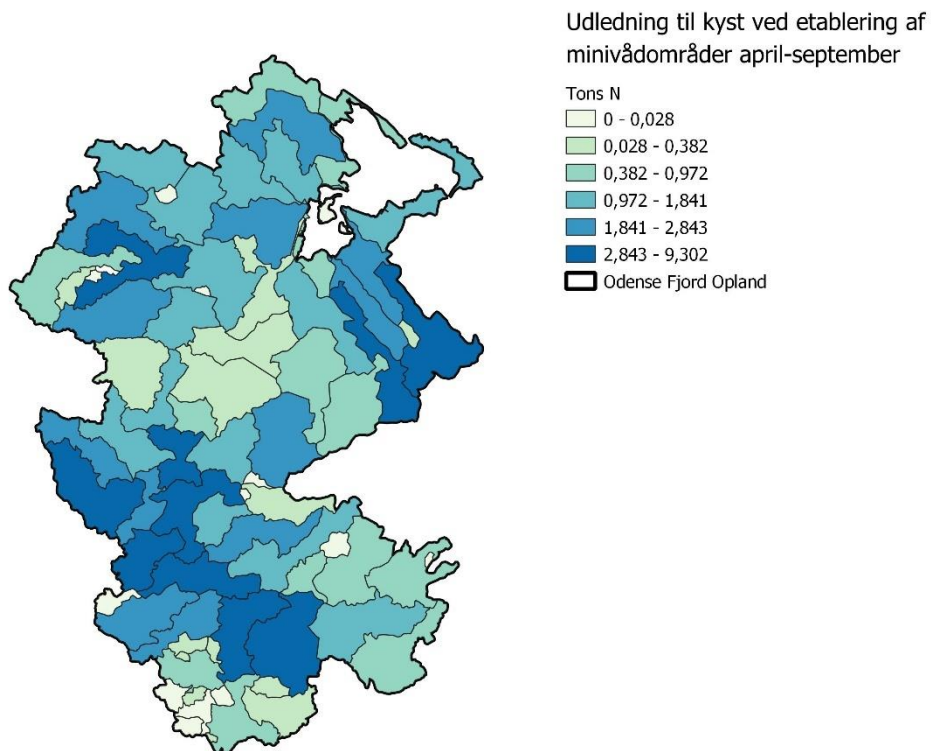

Figure 17: Calculated half-annual (April-September) N-loss from the Odense Fjord catchment to the estuary for each ID15 catchment, if the 127 mini wetlands from Figure 1 are established.

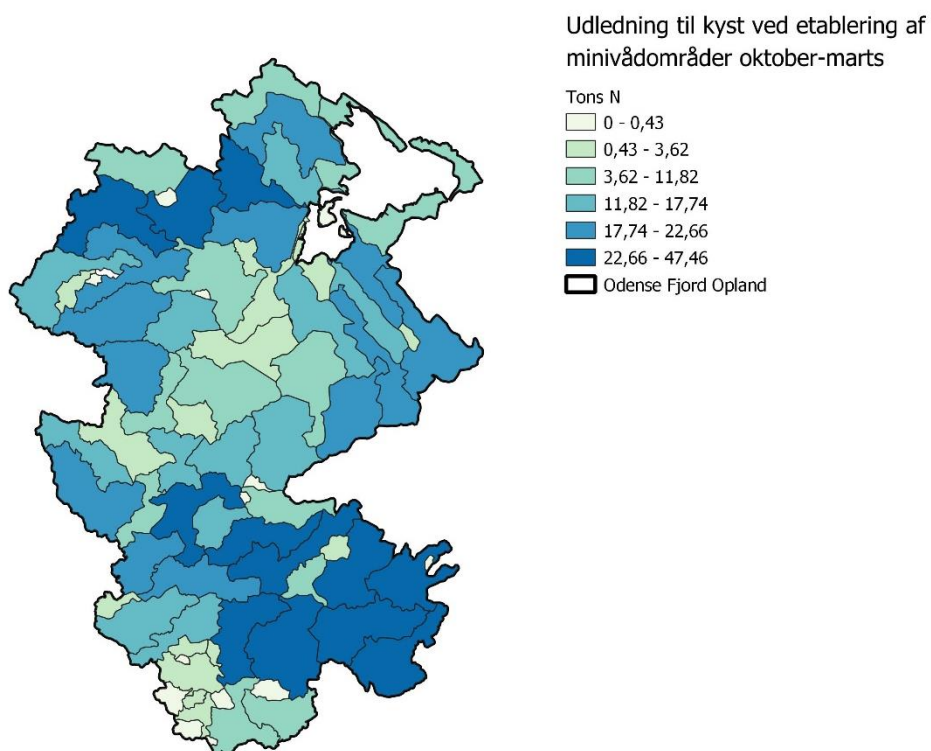

Figure 18: Calculated half-annual (October-March) N-loss from the Odense Fjord catchment to the estuary for each ID15 catchment, if the 127 mini wetlands from Figure 1 are established.

A comparison of figures 4 and 5 once again shows that the half-annual N-loss is highest during the winter months. Likewise, previously shown in Figures 2 and 3, the comparison also indicates that the primary N-loss occurs in different ID15 catchments depending on the different seasons.

The total N-reduction which can be achieved with the establishment of the 127 mini wetlands can be seen in Table 4.

Table 9: Calculated total N-reduction to the estuary which can be achieved in the Odense Fjord catchment by the establishment of the 127 mini wetlands.

Month	All of Odense Fjord catchment (tons N)	4231 (tons N)	4232 (tons N)	4233 (tons N)
January	9,54	0,50	8,50	0,54
February	6,64	0,37	5,85	0,41
March	4,52	0,27	3,98	0,27
April	2,14	0,13	1,91	0,10
May	1,03	0,05	0,91	0,06
June	0,35	0,02	0,31	0,02
July	0,56	0,03	0,50	0,03
August	0,49	0,03	0,45	0,02
September	1,39	0,08	1,27	0,05
October	3,54	0,19	3,25	0,10
November	6,03	0,34	5,53	0,16
December	7,73	0,41	6,95	0,37
All year	43,96	2,42	39,40	2,13

As shown in Table 4, the establishment of the mini wetlands only results in modest reductions of the N-loss to the estuary in some areas. This is further supported when comparing the N-loss to the estuary for the scenarios summer (April-September) with and without mini wetlands (Figures 2 and 4), as well as the winter (October-March) with and without mini wetlands (figures 3 and 5). The two winter and summer maps appear to be identical at first glance. However, a thorough comparison will show that some ID15 catchment enters a lower N-leaching class when mini wetlands are established. Thus, though the total effect of the mini wetlands in the Odense Fjord catchment can be considered limited the establishment of mini wetlands can be of high importance for the local conditions.

References

Eriksen , J., Thomsen, I. K., Hoffmann, C., Hasler, B., & Jacobsen, B. H. (2020). Virkemidler til reduktion af kvælstofbelastningen af vandmiljøet. Aarhus Universitet. DCA - Nationalt Center for Fødevarer og Jordbrug. Hentet 2023 fra <https://dcapub.au.dk/djfpdf/DCArapport174.pdf>

Customizing the instrument selector to handle seasonal variation

RESUMÉ

Virkemiddelvælgeren laver en bedriftsspecifik økonomisk optimering af tilgængelige efterafgrødevirkemidler. Grundlaget for beregningen baseres på hver enkelt bedrifts afgrødevalg i de foregående 5 år. Indsatskravet der beregnes på, er enten det kommende års indsatskrav, eller en række af scenarier med frit valgte indsatskrav. Der er således altid tale om en beregning på fremtidige valg af efterafgrødevirkemidler, baseret på en forventning om at de seneste 5 års afgrødevalg er repræsentative for bedriftens fremtidige drift.

Bedriftens afgrødevalg anvendes til at kortlægge potentialet for efterafgrøder og alternative virkemidler som kan anvendes til at løse efterafgrødekrav. På baggrund af potentialet foretages en økonomisk optimering, som giver et forslag til den billigste løsning af efterafgrødekrav på hver enkelt bedrift.

Tilpasning af Virkemiddelvælgeren til håndtering af årstidsvariation

Virkemiddelvælgeren er blevet tilpasset, så den også kan håndtere optimering når der skal tages højde for årstidsvariation i kvælstofudledning til kyst. Dette notat beskriver datamæssig baggrund for ændring i virkemidlernes relative effekt, og giver eksempler på hvordan korrektionen påvirker beregningerne af den optimale løsning.

Først er der lavet en beregning af den gennemsnitlige årlige reduktion i kg N udledt til kyst for hvert virkemiddel. Effekten på kvælstofudledningen til kyst afhænger af virkemidlernes effekt på kvælstofudvaskningen fra rodzonen og kvælstofretentionen mellem rodzone og kyst. Data vist i tabel 1 er baseret på beregninger på ID15-niveau, der efterfølgende er aggregeret til et arealvægtet gennemsnit for hvert kystvandopland. Virkemidlernes effekt på udvaskningen fra rodzonen er beregnet ud fra relative effekter af virkemidlerne i forhold til den beregnede udvaskning fra rodzonen uden virkemidlerne. De relative effekter er fastsat ud fra forsøg med sugecellemålinger. I disse forsøg er det muligt at sammenholde forsøgsled med og uden et virkemiddel. I forsøgene kan udvaskningen fra rodzonen opgøres både på månedlig og årlig basis. Derfor har det været muligt at opgøre virkemidlernes relative effekter både måned for måned og samlet for hele året.

Slutteligt er der lavet en beregning af forholdstal for reduktionen i perioden april-juli, hvor efterafgrøde destrueret i november er sat til at være lig med 1. Dette anvendes som den nye basisenhed i beregningerne af potentialer og priser for efterafgrødeenheder.

Forholdstallene for virkemidlernes effekt er anderledes for perioden april-juli end for hele året, fordi de forskellige virkemidler ikke virker ens ind på udvaskningen hen over året.

Priserne på virkemidlerne opgøres som kr. pr. hektar efterafgrødevirkemiddel. Dermed betyder en ændring i virkemidlernes indbyrdes vægtning at prisforholdet mellem virkemidlerne også ændres.

For at kunne skifte fra en ”almindelig” efterafgrøde til en efterafgrøde destrueret i november, som basisenhed, tages der i beregningsgrundlaget højde for, hvilken effekt der opnås med den valgte efterafgrøde.

The instrument selector – an algorithm for economic optimization of catch crop measures

The instrument selector makes a farm-specific economic optimization of available catch crop measures. The basis for the calculation is based on the crop choices of each holding over the previous 5 years. The

wagering requirement is either the coming year's wagering requirements, or a series of scenarios with freely chosen wagering requirements. Thus, it is a calculation of future choices of catch crop measures, based on the expectation that the last 5 years of crop choices are representative of the farm's future operation. The farm's crop choices are used to map the potential for catch crops and alternative measures that can be used to meet catch crop requirements. Based on the potential, an economic optimization is carried out, which provides a proposal for the cheapest solution of catch crop requirements on each individual farm.

Data basis and data purification

The data basis for the calculations is based on crop selection registered when applying for basic payment. This dataset basically contains information about each field's size, crop selection and the CVR number applying for the basic payment. With the help of GIS, the dataset is enriched with information about previous years' crop at field level, soil quality (JB no.), postal code, municipality, ID15, coastal water catchment, organic/conventional, possibility of irrigation, proportion of field lying as a 20 m strip to lakes and streams, effort requirements for livestock catch crops, effort requirements for targeted regulation. Catch crop requirements at farm level depend on the amount of organic fertilizer applied. The information on the amount of organic fertilizer used is taken from the fertilizer accounts. Access to fertilizer accounting has been obtained through an application for access to documents. In addition, the fertilizer accounts are used as a data source to identify cattle exemption farms that have specific requirements for grass catch crops. The data cleanup involves transforming the Excel data source into RDS file and standardizing names from columns.

The field dataset consists of several years of extraction. This is because the parcels' affiliation with CVR number only applies for a single year at a time. Therefore, datasets are available for each year from 2016 up to and including the recently completed extractions. In the datasets for 2016 onwards, crop information on previous years has been included and, to the extent possible, also in a subsequent year. This is used in the calculation of catch crop potential, looking at current crop and in some cases subsequent year crop, and previous crop in other cases.

The calculation of potentials

The purpose of the potential calculation is to map the instrument potentials possible to apply to each individual field. Potentials for measures are calculated on the cultivation surface:

- Catch crop after seed grass
- Catch crop after spring seed
- Catch crop after winter seed
- Early sowing
- Intermediate crop after seed grass
- Intermediate crop after cereals
- Catch crops with crop rotation changes
- Precision agriculture
- Energy crops
- N quota reduction
- Fallow along lakes and streams
- Fallow

The potential for catch crops after seed grass is identified by a seedgrass field being followed by a spring sown crop. Technically, this is done by examining whether the crop code of a field in the current year is

seed grass and whether the crop code of subsequent years is within the group of spring sown crops. Thus, it is the farmer's usual crop choice as successor to seed grass that determines whether there is a potential for catch crop or intermediate crop after seed grass. Catch crop after spring seed is identified by a spring sown cereal crop being followed by spring sown crop. Similarly, catch crop after winter seed is identified by a winter seed followed by a spring sown crop. The difference between catch crop after spring seed and winter seed is that the costs in catch crop after winter seed are higher, as it must be sown just before or just after harvest. Catch crops after spring seed can be established as grass same time as the spring seed is sown.

Early sowing of winter seeds is used as a starting point for all first-year wheat. In this context, first-year wheat is defined as wheat established after rapeseed, field pea and spinach. Wheat after seed grass is used in the potential for intermediate crop after seed grass. First-year wheat after other crops, such as potatoes, maize and beets, is not assumed to be established before 7 September and is therefore not recognized as potential for early sowing. On Lolland, Falster and Møn, early sowing is not used at all, therefore the potential is reset using postal codes for these areas. In Southern Jutland, on Funen and Zealand, there are challenges in dealing with resistant grass weeds, therefore the potential for early sowing in these areas is halved. There is no specific knowledge of which farms have these challenges, therefore the halving is a general consideration for all farms in the area.

Intermediate crop after seed grass is identified by a seedgrass field followed by a winter seed. Intermediate crop after grain is basically a total potential of cereal fields, followed by winter seeds. This is referred to as the "total potential of intermediate crop". When using the medium-crop measure, the winter seed may not be sown until after September 20th at the earliest. In order not to exaggerate the potential for intermediate crops, the potential for intermediate crops is limited to a maximum of 20% of the total area under winter seeds, as this creates a balanced use of late sowing. The remainder of the total potential for intermediate crops is used for early sowing of winter seeds after cereals and catch crops with crop rotation changes, respectively. Early sowing of winter seeds after cereals is a measure primarily used in the northwestern part of Jutland. Therefore, this potential is built with a parameter, which is adjusted at postcode level. The parameter is calibrated based on actual use of early sowing.

Catch crops with crop rotation changes are a relatively expensive measure as, in addition to the establishment of a catch crop, there is also a loss when a winter seed is replaced by spring seed. The instrument is used when cheaper measures are used up. The crop rotation change occurs exclusively for winter crops after grain. Thus, areas with first-year wheat are not affected. The basic consideration of this is to maintain each farm's share of crop rotation.

Precision farming serves as an alternative to catch crops. The potential for the instrument is made up of areas cultivated with cereals and rapeseed. 11 ha of precision farming can replace 1 ha of catch crop. The potential is handled in two groups. One group is the holdings that have already been registered for the scheme in previous years. These farms are expected to continue to use the instrument. The cost is recognized without interest and depreciation of precision equipment, since it has already been purchased. The second group is farms with more than 150 hectares, which are generally considered to be of a size that justifies investment in precision equipment. Costs for the instrument are included along with interest and depreciation.

Energy crops serve as an alternative to targeted catch crops. Theoretically, there is a potential corresponding to the rotational area, but as the establishment of energy crops is limited in its actual distribution, it has been chosen to simply suggest current area with energy crop as potential that may

continue at a price of DKK 0 per hectare. Thus, the scope of energy crops does not change in the calculation.

N quota reduction is a measure where a smaller amount of N fertilizer is applied to the farm than the overall norm. The cost of N quota reduction varies greatly depending on the scale used. In the model, N quota reduction is calculated in portions of 5%. This distinguishes between N quota reduction in the 0-5%, 5-10%, 10-15% and 15-20% ranges. The potential for N quota reduction is calculated crop- and soil quality-specific. The calculation of the cost of N-quota reduction is carried out for the 13 crops with the highest distribution, covering approximately 1.9 million hectares in 2022. The crops are shown below sorted by extent:

- Spring barley
- Winter wheat (counted separately for first-year wheat and wheat after cereals)
- Winter rapeseed
- Corn
- Clover grass for feed
- Winter hybrid rye
- Winter barley
- Oats
- Grass without clover for feed
- Ryegrass seed
- Starch potatoes
- Sugar beet for factory

In terms of distribution, three crops are excluded from the list, the largest being "permanent grass with normal yield" that is handled as grass without clover. In addition, there are "environmental grass MVJ commitments without N quota" and "MVJ not set-aside, not agricultural area". The two MVJ grasses do not have N quota and are therefore not relevant in the calculation. In general, all legumes and other crops without N quota are not included in the calculation. The remaining crop codes together make up about 20 per cent of the agricultural area, but separately they occupy less than 1 per cent. Therefore, remaining crops are handled as the one of the above 13 that fits best when looking at the economic loss from reducing the N quota.

Spring rape and grouse are handled like winter rape.

Bread wheat is handled like second-year wheat.

Winter rye is handled as winter hybrid rye.

Maize to maturity is handled like corn for whole seed.

Forage grass with clover and normal yield is handled as clover grass for feed.

Seed grasses are handled according to the same calculation as ordinary ryegrass.

All potatoes are handled like starch potatoes.

Other crops with N quota not mentioned above are allocated a cost corresponding to N-reduction for spring barley.

The loss calculation in "Kalkule Mark" has been carried out by making two crop sequences, one with rapeseed and cereal crops, where wheat after rapeseed is automatically handled as first-year wheat, and wheat after grain as second-year wheat. In addition, the model does not provide effects of crop order. It is the values of each individual crop that are used as the basis for the calculations. The crops that are not cereals are gathered in a crop order of their own.

Using a macro, yields for cereals in quintals of kernel and kg protein per hectare are calculated at N-levels corresponding to full N quota and additionally in 5% increments down to 80% of full-N quota. The loss in quintals of kernel and kg protein are the most important elements of changed yield by N-quota

reduction, but at the same time there is a decrease in straw quantity that reduces earnings and savings on P, K and drying. This is also taken into account in the calculation. The percentage reduction in straw yield follows the 1:1 reduction in core yield. For crops other than cereals, yields shall be calculated in appropriate units and protein losses shall be calculated only in the crops used for animal feed.

The yield is calculated on each soil quality group (JB1+3, JB2+4+10-12, JB1-4 with irrigation, JB5-6, JB7-9) and data are collected in tables. Losses and savings are imported into the Instrument Selector's R-code, where it is converted into total losses based on value of kernel, protein, straw and saved costs for N, P, K and drying per hectare with the crop.

For farms using less than 80 kg of total N from organic fertilizers, 110 kg of N will have to be reduced from 2024 to achieve an effect equivalent to one hectare of catch crop. Farms using more than 80 kg of total N from organic fertilizers must reduce 175 kg of N to achieve the equivalent of one hectare of catch crop. Previously, the rates have been 93 and 150 kg N for below and above 80 kg N respectively.

Fallow along lakes and streams is a relatively attractive alternative to targeted catch crops, as the remedy has a 4:1 effect compared to catch crops. Thus, 1 ha of fallow along lakes and streams can solve 4 ha of catch crop requirements. The potential for fallow land along lakes and streams is calculated on the basis of the most recently known areas and their location in relation to possible strip areas down to lakes and streams.

Fallow is defined as the last (and most expensive) resort when it is not possible to solve the effort requirement with other alternatives. The fallow potential is the rotational area less the area used as fallow potential along lakes and streams. In the same way as fallow along lakes and streams, the last known rotational area is used as the basis for calculating the total potential for fallow.

5 years data basis and farm type

Since knowledge about future crop choices are not available at the time of calculating, the starting point is historical crop choices. At present, crop selection in 2023 is the latest dataset available. The calculation of the potential for catch crops can thus only be made up to and including the crop in 2022, which is followed by a spring sown crop in 2023. To provide a more stable data basis, calculations are made for 2022-23, 2021-22, 2020-21, 2019-20 and 2018-19. Each year's potential for the catch crop instrument is converted into the proportion of the rotational area that can be used for a given catch crop potential. Subsequently, an average of these shares is multiplied by the rotational area for 2023. In this way, it is the farm's crop selection over a 5-year period that forms the basis for which catch crop measures will typically be available on the individual farm. It has been taken into account that the rotation area may have changed during the period.

The 5-year average is only used for catch crop measures that depend on cultivation history. Fallow along lakes and streams does not depend on what has been cultivated, but on which fields are available here and now. Therefore, the potential for fallow along lakes and streams is calculated solely on the basis of the latest available field data. The N quota reduction, which is crop and soil quality specific, is calculated on the basis of the distribution of crops that has occurred in the latest available year. This implicitly assumes that the composition of crops and the distribution by soil quality will be equal to the most recent observation.

As a starting point, it is required that there is a 5-year cultivation history for all farms. It is taken into account whether the farm has the same type throughout the period. This is specially designed to cater for farms that may switch to or from the application of the cattle exemption. Farms using the cattle

exemption have a relatively simple crop rotation and therefore only 3 years of data are required for these. For all other holdings, it is verified whether the type of holding is the same during the period of the last 5 years. The type of farm is determined on the basis of information from the fertilizer accounts. Cattle exemption farms have a specific marking in the fertilizer accounting. Other cattle farmers are defined on the basis that more than half of the phosphorus content in their own manure must come from cattle, and at the same time the amount of phosphorus must be higher than the amount from 40 dairy cattle with reared cattle. To be defined as a pig producer, more than half of the phosphorus content in own manure must come from pigs. Other livestock farms consist of remaining farms using their own manure exceeding 100 kg phosphorus per year. Arable farms are defined as the remaining group of farms, and significant amounts of manure can easily be used on these farms but does not come from own production.

Corrections to the potential calculation

The potential calculation is based on the actual crop choices in each field. This is a very good basis for the calculation, as it is precisely the choice of each farm that is the basis for the optimization. However, it has the inexpediency that the entire planned area of winter seed cannot be established every year. In Years where the weather limits the area with winter seeds, spring sown crops will take up more space than planned. If this is not corrected, the potential for catch crops will be calculated to be greater than what is realized. An area that was planned with winter seed is not used for a catch crop, as winter seeds are planned, and it is only the weather in the autumn that ends up changing the crop to a spring sown. A correction is made for this by calculating the ratio of each farm between winter and spring sown crops each year. In the years when the winter crop area is lower than normal, the potentials for catch crops are corrected. The correction is made at farm level.

In addition, a correction can be made to the potential for N-quota reduction. The basis for this correction is that farms on clay soils with a large amount of manure may have difficulty achieving the calculated statutory nitrogen utilization. As a result, crops are already under-fertilized, and the lowest levels of N quota reduction have already been applied. This is handled by postcode and can indicate which soil quality groups, and which amount of total N in organic fertilizer should have a correction on available N quota reductions. Thus, JB5-9 can be individually taken into account, with more than 140 kg total N from organic fertilizer, and remove, for example, 4 percentage points of the potential for N quota reduction between 0 and 5 per cent on these farms. In the optimization, there will then be 1 percentage point left of the potential, 0-5 percent, and the farm will experience that the cheap part of the N-quota reduction runs out faster in the optimization.

Handling GLM-8 and the biodiversity bioscheme

The requirement of 4 per cent non-productive land is dealt with by looking at how much fallow land there is on each farm. Any difference between claims and actual fallow shall be calculated and this area shall be withdrawn from the rotation area. A set-aside cost of 60 % of the calculated set-aside price is included in GLM, since it is assumed that with planned set-aside of small areas marginal areas can be chosen and thus a smaller cost than ordinary fallow out of rotation.

The biodiversity bioscheme offers the possibility of getting a 1% discount on the 4% set-aside requirement by having at least 7% fallow.

The choice between 4 and 7 % set-aside is made in the model by calculating both scenarios throughout the model, and finally comparing the total cost of 4 and 7 % fallow, respectively. The subsidy for the bioscheme is deducted from the cost of set-aside.

The reason for calculating the entire model with 4 and 7 % fallow, respectively, is to be able to handle varying effort requirements in the targeted regulation. With 7% fallow, there are fewer areas to supply efforts for the targeted regulation, and thus the model will show that with increased effort requirements in the targeted regulation, there will be fewer farms that choose 7% fallow.

Cost of the individual instruments

The cost of each instrument is calculated as a starting point in DKK per hectare. Subsequently, the cost is converted to DKK per catch crop unit "EA".

The price assumptions for the calculations depend on the application of the model. When calculations are made for use in the coming season's choice of instruments, prices are used based on the latest price forecast from SEGES Innovation. A price vector is used with prices for "current year" and prices for "subsequent year". This is due to the fact that the catch crop schemes have different year of belonging. The N quota reduction applied in this year by targeted regulation is a real reduction in this year, while the N quota reduction used in mandatory and livestock catch crops will only be deducted from the fertilizer quota in subsequent years. Other instruments belong to the same year. For crop rotation change, the following year's price for winter seed is lost and next year's price for spring seed is obtained.

Calculations for scenarios with increasing effort requirements, on the other hand, are based on long-term prices, and in this situation the price is the same for "current year" and "subsequent year". In the examples shown below, long-term pricing assumptions have been selected as shown in Table 1.

Table 1. Long-term price assumptions used for scenario calculations

Wheat	130	DKK pr. hkg
Barley	125	DKK pr. hkg
Rye	115	DKK pr. hkg
Rapeseed	310	DKK pr. hkg
Oats	115	DKK pr. hkg
Corn silage	107	øre pr. FEN
Clover grass silage	128	øre pr. FEN
Ryegrass	900	DKK pr. hkg
Starch potatoes	65	DKK pr. hkg
Sugar beet	22	DKK pr. hkg
N	7	DKK pr. kg N
P	14	DKK pr. kg P
K	6,5	DKK pr. kg K
Straw	0,55	DKK pr. kg
Value of supplement protein	3,8	DKK pr. kg

The calculation of the price of catch crop after winter sowing is made as shown in Table 2.

Table 2. Calculation of the price of catch crop after winter sowing.

Catch crop after winter seed	Sandy soil		Clay soil	
	<80 kg N	>80 kg N	<80 kg N	>80 kg N
DKK per hectare				
Seeds	240	240	240	240
Sowing	180	180	180	180
After effect N (mandatory)	-119	-175	-119	-175
Yield effect	-125	-125	0	0
Success rate establishment	21	21	21	21
Subsidy	-637	-637	-637	-637
Cost without subsidy	197	141	322	266
Cost incl. subsidy	-440	-496	-315	-371
DKK per hectare EA (catch crop)				
Cost per hectare EA without subsidy	197	141	322	266
Cost per hectare EA incl. subsidy	-440	-496	-315	-371

The calculation is made with the following assumptions:

Catch crop after winter seed			
Seed	Type	Oil radish	
	Amount	10	kg
	Price	24	DKK per kg
Sowing	Method	Row sowing	
	Price	180	DKK per hectare
After effect N (mandatory)	< 80 kg N	17	kg N
	> 80 kg N	25	kg N
	< 80 kg N	-119	DKK per hectare
	> 80 kg N	-175	DKK per hectare
Yield effect	Sandy	1	quintal per ha
changed yield in subsequent spring crop	Clay	0	quintal per ha
Yield effect	Sandy	-125	DKK per hectare
starting point in spring barley price	Clay	0	DKK per hectare
Success rate establishment		5	pct. is established, but the catch crop does not succeed
Loss from unsuccessful establishment of catch crop		21	DKK per hectare

Similarly, calculations have been made for the other catch crops and intermediate crops.

Catch crop after seed grass is special because it does not require the establishment of a crop, but simply the value of the after effect.

Catch crops with changed crop rotation are calculated as catch crops after winter seeds, as it is usually a second-year wheat field that is replaced by catch crops and subsequent spring seeds. However, the main part of the costs is the difference in gross margin between winter and spring seeds. The calculation is made as shown in Table 3. The calculation is based on contribution margin I (DB) for spring barley. Adjustments are made by 30% of the machine costs, corresponding to the variable part of the machine costs for diesel and maintenance. Salary, remuneration and depreciation are assumed unchanged as no capacity adjustment is made. This is compared with DB for winter seed (second-year winter wheat), where 30 % of machine costs are also adjusted.

Table 3. Calculation of lost earnings when switching from winter to spring seed

	JB 5-6	
	<80 kg N	>80 kg N
DB spring seed	8.127	9.117
Machine cost spring seed	4.720	4.998
30 % of machine costs, spring seed	1.416	1.499
DB spring seed, corrected for machine cost	6.711	7.618
DB winter seed	10.432	11.545
Machine cost winter seed	5.646	6.005
30 % of machine cost	1.694	1.802
DB winter seed, corrected for machine cost	8.739	9.744
Lost DB by change in crop rotation	2.027	2.126

The contribution calculations are made so that changes in transfer prices can be handled by entering a total price list. When calculating next year's proposal for catch crop composition, it is taken into account that the economic consequences of change in crop rotation will only take effect with the following year's harvest. Therefore, there is a price set for the current year's crop prices, and one for next year's prices. The current year's prices are used as the basis for the cost of N quota reduction, as it is the current year's crop volume that is reduced. In addition, the current year's price is used to calculate the cost of yield reduction in spring barley with grass seed as catch crop, because a small yield loss is experienced in spring barley with grass outlay on clay soil. If the cost of catch crops is calculated in general, prices are set at the same level in "this year" and "subsequent years".

Early sowing is set at DKK 0 per hectare. There is a small saving on the amount of seed from early sowing, which is expected to equal additional costs for handling an increased risk of lice.

Fallow is intended as the set-aside of land in rotation with a short time horizon without capacity adjustment. The contribution margin loss is calculated on the basis of a typical crop rotation with winter barley, winter rapeseed, winter wheat, winter wheat, spring barley. The calculation is shown in Table 4. On farms using more than 80 kg total N from organic fertilizer, additional costs for replacement grain of DKK 10 per quintal are included, as the grain that is no longer bred on the farm must be purchased and thus transported to the farm. An additional cost of increased transport distances for manure to be applied to areas further away than current areas is also included.

Table 4. Calculation of set-aside costs

Calculation of lost contribution margin	JB 5-6	
	<80 kg N	>80 kg N
Avg. cereal yield quintals per hectare		74
Lost contribution margin	9.985	11.076
Machine cost	5.209	5.565
30 % of machine cost	1.563	1.669
Lost contribution margin corrected for machine cost	8.422	9.406
Care of fallow land	250	250
Rescheduling every 5 years	200	200
Replacement cereals, additional price		740
Manure transport (extra)		300
Subsidy	-637	-637
Cost without subsidy	8.872	10.896
Cost incl. subsidy	8.235	10.259
DKK per hectare EA		
Cost per hectare EA without subsidy	8.872	10.896
Cost per hectare EA incl. subsidy	8.235	10.259

In the targeted regulation, fallow along streams and lakes has an effect of 4:1, i.e. 1 hectare set aside in 20 metres of strips along lakes and streams counts as 4 hectares of catch crop. The calculation of the cost of fallow along lakes and streams follows the above calculation of fallow, but the subsidy per hectare will be 4 times as large because the subsidy is given per hectare of catch crop.

Precision farming can be used as a catch crop instrument with a factor of 11:1, i.e. precision farming of 11 ha with cereals or rapeseed can replace 1 ha of catch crop. The cost of using precision farming is highly dependent on the starting point of the individual farm, including whether the necessary equipment has already been invested. Since it is not possible to have knowledge of these different starting points, an estimate of low and high costs has been made, and subsequently a medium level of these has been used. This is shown in Table 5.

Table 5. Calculation of precision farming costs

Precision farming costs			
Per 100 hectares	Low	High	Average
Yield 1-3 quintals	-10.000	-30.000	-20.000
Slurry analyses	0	6.000	3.000
Consultancy	0	10.000	5.000
Operational management	2.000	6.000	4.000
Interest and depreciation	5.000	25.000	15.000
Total per 100 hectares			7.000
Total per hectare			70
Total cost per hectare catch crop requirements (11 ha) without subsidies			770
Subsidy			-637
Cost per hectare catch crop requirements incl. subsidy			133

For farms that have already invested in precision farming equipment, the decision to use it will depend on the marginal cost. Thus, the interest and depreciation of the equipment can be withdrawn from the calculation. Thus, precision agriculture is recognized as an ongoing gain of DKK 1,517 per hectare for farms that have already invested in the equipment.

Effort requirements at farm level

The effort requirement for each scheme shall be calculated at farm level. The basis is each individual field's effort requirements. The effort requirement at field level is summed up to farm level. Compulsory and livestock catch crops are effectively solved at farm level. Targeted catch crops must be located in the coastal catchment area to which the requirement belongs. In the first years, the instrument selector has been designed to solve all the requirements at farm level. Later, a function has been developed that identifies the effort requirement at catchment area level, and subsequently solves the requirement at catchment area level. For calculations made in the long term, the solution has been to calculate at farm level, as the division at catchment area level, places greater demands on the data basis than it has been possible to provide so far. This applies specifically to knowledge of crop selection in the following year. Since the model is based on information from the application for basic payment, information about planned crops is not available.

The possibilities in the catchment model are primarily to be able to provide a proposal to the individual farm about the coming year's specific choice of catch crop measures, on farms that have land in several catchment areas. Work is underway to develop a crop forecast at field level, which can provide a qualified guess as to which crop is expected to be grown in each field. This makes it possible to create a data basis that can exploit the function of catchment area with different effort requirements in targeted regulation in the following year of cultivation.

In its current form, the model can calculate on effort requirements divided at catchment area level for historical years. In terms of calculation, it only makes sense to make catchment calculations on a single year at a time, as it is precisely the actual crop choice in the year that determines the potential of the

specific catchment area for each individual year. Therefore, a balanced potential calculation with 5 years of data basis is not made when calculating the effort requirements divided by catchment areas.

Optimization using linear programming

When both effort requirements and potentials have been mapped at farm level, an optimization is carried out that ensures that the cheapest available solution is used on each individual farm. The optimization is built as linear programming where the yield is maximized. When maximization is chosen, positive yield values can be interpreted as a situation where the use of the instruments gives a positive yield for the farm, while negative values are interpreted as a cost.

The object function for an example of a farm with three instruments is as follows:

$$x_1v_1 + x_2v_2 + x_3v_3 = \textit{yield}$$

Subject to:

$$x_1 + x_2 + x_3 = \textit{catch crop requirements}$$

$$x_1 \leq \textit{potential } x_1$$

$$x_2 \leq \textit{potential } x_2$$

$$x_3 \leq \textit{potential } x_3$$

x_j is the amount of instrument No j , which corresponds to one ha catch crop requirement
 v_j is the cost in DKK. for the quantity of instrument No j corresponding to one hectare catch crop requirements. Some instruments have "positive costs" because the subsidy to use the instrument exceeds the actual costs. This applies, for example, to catch crops after seed grass, where there are no costs for establishment, but simply a subsidy for using the instrument in the targeted regulation. The actual object function is significantly longer, as there are many instruments in the model. Therefore, the matrix of conditions is correspondingly larger. Below is a basic sketch of how the matrix with conditions is structured and how it is interpreted. The starting point is the model that can handle catchment area optimization at farm level for the targeted regulation. Measures on the cultivation surface, such as catch crop, intermediate crop, early sowing, fallow along lakes and streams and fallow are mapped for the holding in the coastal water basins where land is farmed. This is referred to as "local instruments" because they have a local connection to a given coastal water catchment. The local measures are subsequently divided into "catch crops" and into "local alternatives". This is because only "real" catch crops can be used in solving the requirement for cattle exemption, which is referred to here as "kvundt". Measures applicable to the entire farm, such as quota reduction (N quota) and precision agriculture, are mapped at farm level. These are referred to as "non-local instruments" because in current regulation they are used at farm level without specific connection to a given location. The reduced allocation of nitrogen does indeed occur in a given field, but it is not (yet) a requirement for it to occur in the given coastal catchment area where the effect is used. The connection of the instruments to a given catchment area is listed below with an i .

	Targeted requirement (MEA)			Mandatory & Livestock requirement (PHEA)			Kvundt			
	Non-localM	CatchCropM(i)	LocalAltM(i)	Non-localU(i)	CatchCropU(i)	LocalAltU(i)	CatchCropU(i)			
A	1	1	1	0	0	0	0	=	Targeted requirement	
B	0	1	1	0	0	0	0	<=	Targeted requirement (i)	
C	0	0	0	0	0	0	1	=	Kvundt	
D	0	0	0	1	1	1	0	=	Mandatory & Livestock requirement	
E	I	0	0	I	0	0	0	<=	Non-local alternative potentials	
F	0	I	0	0	I	0	I	<=	Catch crop potentials (i)	
G	0	0	I	0	0	I	0	<=	Local alternative potentials (i)	
	1	A row vector with only 1s								
	0	A row vector with only 0 (zeros)								
	0	A matrix with only 0 (zeros)								
	I	Identity matrix, i.e. matrix with 1s along diagonal and or only 0 (zeros)								

A: The targeted requirement (MEA) can be solved with a combination of all available instruments. Therefore, there are 1s in the top line that mark the use of "non-localM", "catchCropM(i)" and "LocalAltM(i)". The M indicates that the price of the instruments is with a subsidy. The price of the measures for "kvundt", compulsory and livestock catch crops is shown with a U, indicating that it is WITHOUT subsidies. The same instrument is thus included as a possible solution for several schemes, but it is kept track of which scheme it is used in and the pricing fits the given scheme. The top line has an equal sign, as the targeted requirement must be solved exactly.

B: Catch crops or local alternatives must be less than or equal to the targeted catchment area requirement, so that it cannot be over-met in a catchment area.

C: Grass catch crop requirements on Kvundt farms must be solved with catch crop measures, and this is a farm requirement.

D: Compulsory and livestock catch crops can be solved with "non-localU", "CatchCropU(i)" and "LocalAltU(i)", which indicates the same measures as in A, but only that they are prices calculated without subsidies.

E: "Non-local" alternative potentials, such as precision agriculture and N-quota reduction, can be used for both targeted requirements and mandatory & livestock requirements, but must remain below the overall potential.

F: The catch crop potential can be used in all schemes, but never exceed the total requirement.

G: Local alternatives to catch crops, such as intermediate crops, early sowing, etc. can be used for targeted catch crop requirements and mandatory & livestock requirements, but do not exceed the total potential.

The result of the optimization is a combination of measures that solve the effort requirement as cheap as possible for the individual farm.

In the case of calculations for the whole coastal water basin, or the whole country, the calculation shall be repeated for each holding. Each farm's solution is independent of that of other farms. The results are summed up at catchment area or country level afterwards.

As the model is based on individual steps with mapping of potential, calculation of price, optimization and presentation, it is possible to make scenario runs for varying effort levels and different price levels.

Appendix 2

Customizing the Instrument Selector to handle seasonal variation

The instrument selector is built to provide a proposal for an economically optimized solution of effort requirements on the cultivation surface handled with catch crops and alternatives to catch crops. The calculations are based on the scheme as described in the [Vandområdeplanerne 2021-2027](#). In this scheme, the annual load has been used, as well as the annual reduction of the measures on the cultivation surface.

In order to expand the basis of use of the Instrument Selector, an adjustment has been made to handle optimization when seasonal variation in nitrogen emissions to coastal areas must be taken into account. This note describes the data background for changes in the relative effect of the instruments and provides examples of how the correction affects the calculations of the optimal solution. Data for effects are shown as examples for Ringkøbing Fjord, Kolding Fjord, indre and Odense Fjord, Seden Strand. This shows the difference between a sandy soil catchment area (Ringkøbing) and two clay soil catchments Kolding and Odense. Data for solutions is only shown for the catchment area of Odense Fjord, Seden Strand.

Change in relation to the mutual effect of the instruments

First, a calculation has been made of the annual reduction in N for each measure. This is shown in Table 1. The effect on nitrogen emissions to the coast depends on the effect of the measures on nitrogen leaching from the root zone and the nitrogen retention between root zone and coast. The data shown in Table 1 are based on ID15-level calculations that are subsequently aggregated into an area-weighted average for each coastal water. The effect of the instruments on leaching from the root zone has been calculated based on relative effects of the instruments compared to the calculated leaching from the root zone without the instruments. The relative effects are determined on the basis of experiments with suction cell measurements. In these trials, it is possible to compare experimental joints with and without an instrument. In the experiments, leaching from the root zone can be calculated both on a monthly and annual basis. Therefore, it has been possible to calculate the relative effects of the measures both month by month and overall for the whole year. The relative effects monthly, have been used to calculate the effect of the instruments on nitrogen emissions to the coast in the period April-July as shown in Table 2.

Table 1. Reduction in nitrogen emissions throughout the year, average kg N emitted to coast per hectare with instruments in the catchment area.

nr.	Coastal waters	Catch crops November	Catch crops March	Catch crops (60/40 mix)	Inter- mediate crops	Early sowing	Ammount of kg N for effect of 1 ha catch crop Sand	Ammount of kg N for effect of 1 ha catch crop Clay	Fallow
132	Ringkøbing Fjord	5,84	6,86	6,25	3,66	2,82	125,14	115,73	11,96
124	Kolding Fjord, indre	9,76	11,52	10,46	5,20	5,12	123,00	122,92	18,73
93	Odense Fjord, Seden Strand	8,34	9,92	8,98	3,50	4,71	126,24	138,27	14,94

Table 2. Reduction in nitrogen emissions April-July, average kg N emitted to coast per hectare with instruments in the catchment area

nr.	Coastal waters	Catch crops November	Catch crops March	Catch crops (60/40 mix)	Inter-mediate crops	Early sowing	Ammount of kg N for effect of 1 ha catch crop Sand	Ammount of kg N for effect of 1 ha catch crop Clay	Fallow
132	Ringkøbing Fjord	0,85	1,01	0,91	0,44	0,38	144,39	134,37	1,83
124	Kolding Fjord, indre	0,80	0,96	0,86	0,36	0,37	153,62	152,27	1,68
93	Odense Fjord, Seden Strand	0,53	0,64	0,57	0,17	0,22	175,12	175,04	1,09

Ratios between the instruments are calculated for reductions throughout the year. This is shown in Table 3.

Table 3. Ratio for reduction in nitrogen emissions to the coast throughout the year (catch crop November = 1)

nr.	Coastal waters	Catch crops November	Catch crops March	Catch crops (60/40 mix)	Inter-mediate crops	Early sowing	Ammount of kg N for effect of 1 ha catch crop Sand	Ammount of kg N for effect of 1 ha catch crop Clay	Fallow
132	Ringkøbing Fjord	1,00	1,17	1,07	0,63	0,48	125,14	115,73	2,05
124	Kolding Fjord, indre	1,00	1,18	1,07	0,53	0,52	123,00	122,92	1,92
93	Odense Fjord, Seden Strand	1,00	1,19	1,08	0,42	0,56	126,24	138,27	1,79

And finally, a calculation has been made of ratios for the reduction in the period April-July, where the catch crop in November is set to be equal to 1. This is shown in Table 4. The proportions for the effect of the instruments are different for the period April-July than for the whole year, because the different instruments do not have the same effect on leaching throughout the year.

Table 4. Ratio of reduction in nitrogen emissions to coast April-July (catch crop November = 1)

nr.	Coastal waters	Catch crops November	Catch crops March	Catch crops (60/40 mix)	Inter-mediate crops	Early sowing	Ammount of kg N for effect of 1 ha catch crop Sand	Ammount of kg N for effect of 1 ha catch crop Clay	Fallow
132	Ringkøbing Fjord	1,00	1,19	1,08	0,52	0,45	144,39	134,37	2,15
124	Kolding Fjord, indre	1,00	1,20	1,08	0,46	0,46	153,62	152,27	2,10
93	Odense Fjord, Seden Strand	1,00	1,21	1,08	0,33	0,42	175,12	175,04	2,06

Change in the model

The general regulation is based on making reductions in the annual emission of nitrogen from the cultivation surface. Although the model adapts to handle seasonal variation, part of the basic structure is preserved.

The original basic unit was one hectare of catch crop. Whether the catch crop is grown on clay soil or sandy soil, one hectare of catch crop counts for one unit in the model. The new basic unit is one hectare of catch crop destroyed in November. This is similar to normal practice on clay soils. Therefore, the new unit for catch crop is "Catch crop on clay soil".

In order to compare the relative effect of the instruments between the current regulation and a regulation that takes into account seasonal variation, a comparison of the relative effects has been made, which is shown in Table 5.

Table 5. Relative effects

Relative Effects	Base Annual load	With seasonal variation		
	Nationwide	Odense Fjord, Seden Strand	Kolding Fjord, indre	Ringkøbing Fjord
Catch crop clay (November)	1	1	1	1
Catch crop sand (March)	1	1,21	1,2	1,19
Intermediate crop	0,5	0,33	0,46	0,52
Early sowing	0,5	0,42	0,46	0,45
Fallow	1	2,06	2,1	2,15
Fallow along lakes and streams	4	4	4	4
Precision agriculture 1:11	0,090909	0,090909	0,090909	0,090909
kg N for effect of 1 ha catch crop below 80*	110	175	152	144
kg N for effect of 1 ha catch crop above 80*	175	175	152	144

* Below/above 80 refers to farms using below and above 80 kg N respectively from organic fertilizers.

The relative effect of the instruments is used when the potential amount for each instrument is calculated. First, each instrument is calculated in nominal area (hectares), then this area potential is multiplied by the relative potential of the instrument. In the general scheme, no distinction is made between catch crops on sandy soils and clay soils, but in the model adapted to handling seasonal variation, 1 hectare of catch crop on sandy soil gives a catch crop potential corresponding to 1.21 hectares of catch crop if it is in the catchment area of Odense Fjord. Thus, a hectare with catch crop on sandy soil solves 1.21 times as much of the effort requirement as a hectare with catch crop on clay soil.

The same applies, for example, to fallow, which solves 2.06 ha catch crop requirements per hectare set aside, taking seasonal variation into account.

The N quota reduction is handled in the optimization with different rates depending on whether the farm uses more or less than 80 kg N from organic fertilizer. In the calculation of effects from N-quota reduction, a distinction has instead been made between sandy soil and clay soil. As the model cannot handle this distinction without significant changes, it has been chosen at this stage to use the effect of the primary soil type in the catchment. The power is applied directly to both above and below 80 kg N per ha. Thus, the calculated effect for clay soil will be used in Kolding and Odense, while the calculated effect for sandy soil is used in Ringkøbing.

Cost per hectare of catch crop changes

The prices of the measures are calculated as DKK per hectare of catch crop measures. Therefore, a change in the relative effect of the instruments means that the price relationship between the instruments also changes. Table 6 below shows how the conversion of the price from DKK per hectare to DKK per hectare with catch crop (EA) differs when annual load and seasonal variation are used, respectively.

Table 6. Example of calculating the price of catch crops after spring seed

DKK per hectare	Sandy soil		Clay soil	
	<80 kg N	>80 kg N	<80 kg N	>80 kg N
Seeds	160	160	160	160
Sowing	120	120	120	120
After effect N (mandatory)	-119	-175	-119	-175
Yield effect	0	0	125	125
Successrate establishment	14	14	14	14
Subsidy	-637	-637	-637	-637
Cost without subsidy	175	119	300	244
Cost incl. subsidy	-462	-518	-337	-393
DKK per hectare EA (annual load)				
Cost per hectare EA without subsidy	175	119	300	244
Cost per hectare EA incl. subsidy	-462	-518	-337	-393
DKK per hectare EA (with seasonal variation)				
Cost per hectare EA without subsidy	145	98	300	244
Cost per hectare EA incl. subsidy	-382	-428	-337	-393

The ranking of the prices can be seen in Figure 1 and Figure 2. First of all, catch crops after seed grass and maize appear for both sand and clay, as the price differs with the new weighting. There are changes in the ranking, which turns out for intermediate crop after grain, which, with a lower weighting, becomes somewhat more expensive. In addition it is noted that the price of N quota reduction (norm reduction) becomes more uniform when seasonal variation is taken into account. Although 175 kg N is used as a unit for farms above and below 80 kg N from organic fertilizers, the price of the active product will not be the same for both groups. This is due to the fact that the value of protein lost is only half in the case of farms using less than 80 kg N from organic fertilizers. These farms are not supposed to use cereals for animal feed, and thus do not achieve full settlement of the actual protein content. In addition, the phosphorus savings are not included for farms using more than 80 kg N from organic fertilizers.

Cost pr. hectare catch crop

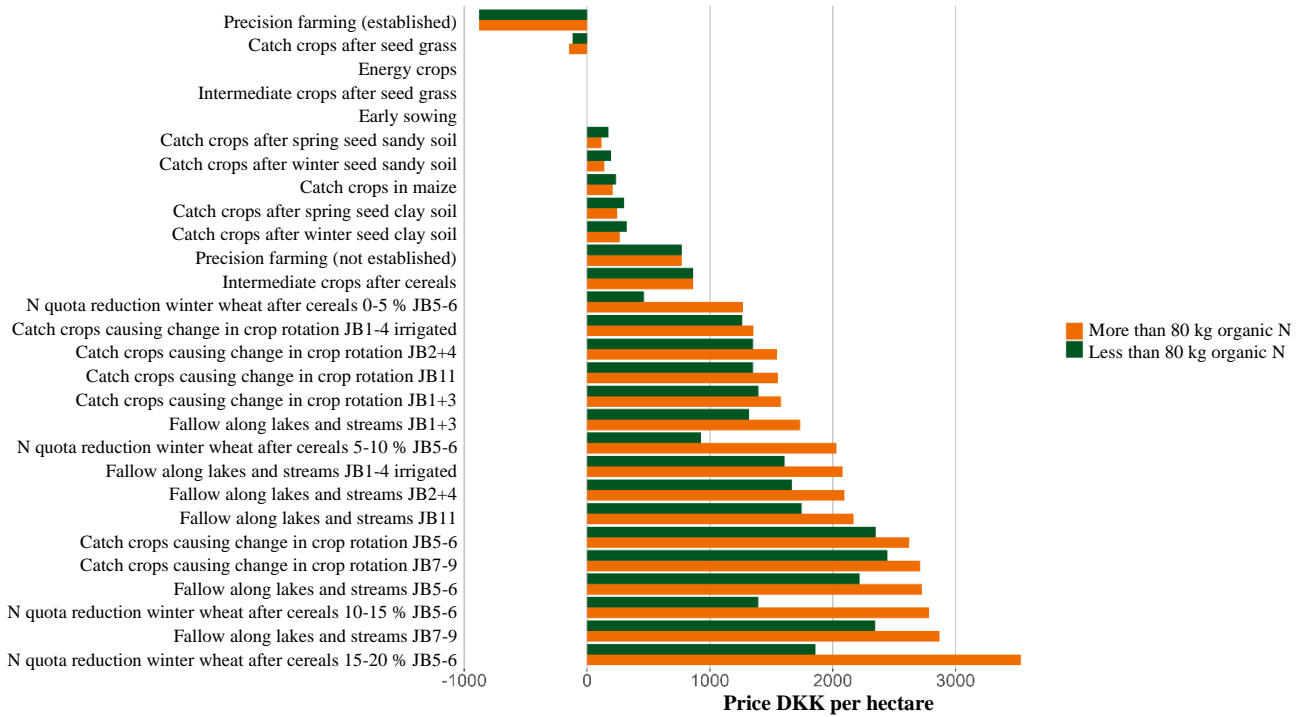

Figure 1. Cost per hectare catch crop requirement at annual load

Cost pr. hectare catch crop

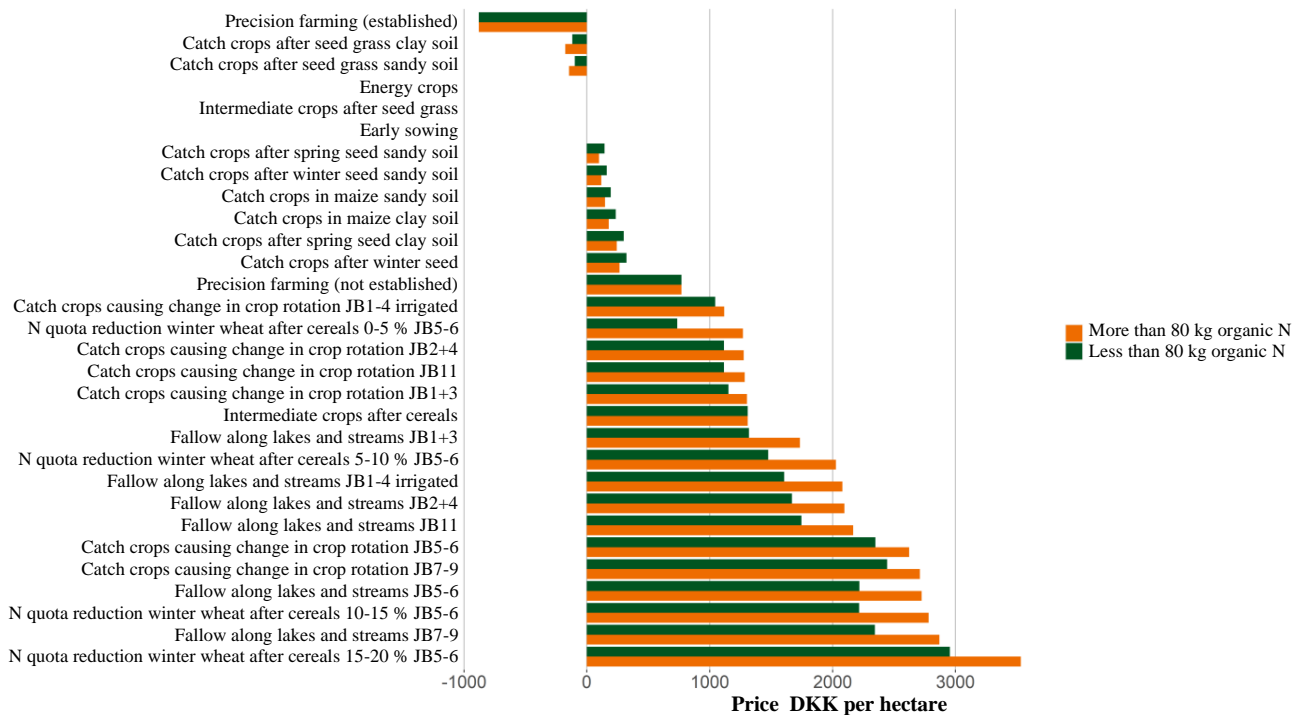

Figure 2. Cost per hectare catch crop requirements with seasonal variation

The effort requirement for the model is still calculated in percentage targeted catch crops of the catch crop base area. However, when a waging requirement is to be calculated, it is based on a significantly

lower waging requirement. This is because the need to reduce emissions in the period April-July is at a lower level.

Example of calculating effort requirements

When annual load is calculated, the effort requirement in the catchment area of Odense Fjord, Seden Strand, can be calculated as follows: A reduction of, for example, 180 tons of N, corresponding to the effort requirement in "targeted regulation 3,500 tonnes N***" from [Vandområdeplanerne 2021-2027](#). The effect of a catch crop destroyed in November has a calculated effect of 8.34 kg N per hectare, as shown in Table 1. The value is based on a root zone effect of 22.8 kg N per hectare, corrected by a retention of 63.5 per cent. $22.8 \cdot (1 - 0.635) = 8.34$. This means that $180,000 / 8.34 = 21,582$ ha of catch crops must be used. The catch crop base area in the catchment area of Odense Fjord, Seden Strand, is 38,446 ha, thus giving an effort requirement of $21,582 / 38,446 = 56.1$ per cent of the catch crop base area. In the current regulation, the effect of catch crops is set at 33 kg N per hectare in the root zone, which is one of the reasons why the effort requirement in the catchment area of Odense Fjord, Seden Strand in 2024 is not 56.1 per cent of the catch crop base area.

The calculation of effort requirements, when seasonal variations are taken into account, is carried out in the same way. However, the effort requirements in the period April-July are significantly lower.

An effort of 10,000 kg N in the period April-July, solved with an effect of 0.53 kg N per hectare of catch crops, thus requires 18,867 ha of catch crop, corresponding to 49 per cent of the catch crop base area.

The above efforts are just examples, and there is no correlation between the two calculations. The examples are only made to show how the calculation is carried out, and that in both cases an effort is calculated that is measured as a percentage of the catch crop base area. This value is used as the basis for the calculation in the Instrument Selector regardless of this value being an annual reduction or a reduction in the period April-July.

Example results

In order to show how the optimization gives different results when the weighting between the instruments changes, Figure 3 shows how the instruments are selected in total for all farms for different scenarios for Odense Fjord, Seden Strand by the normal weighting of the annual effect of the measures.

Distribution of instruments in various scenarios, coastal water Odense Fjord, Seden Strand

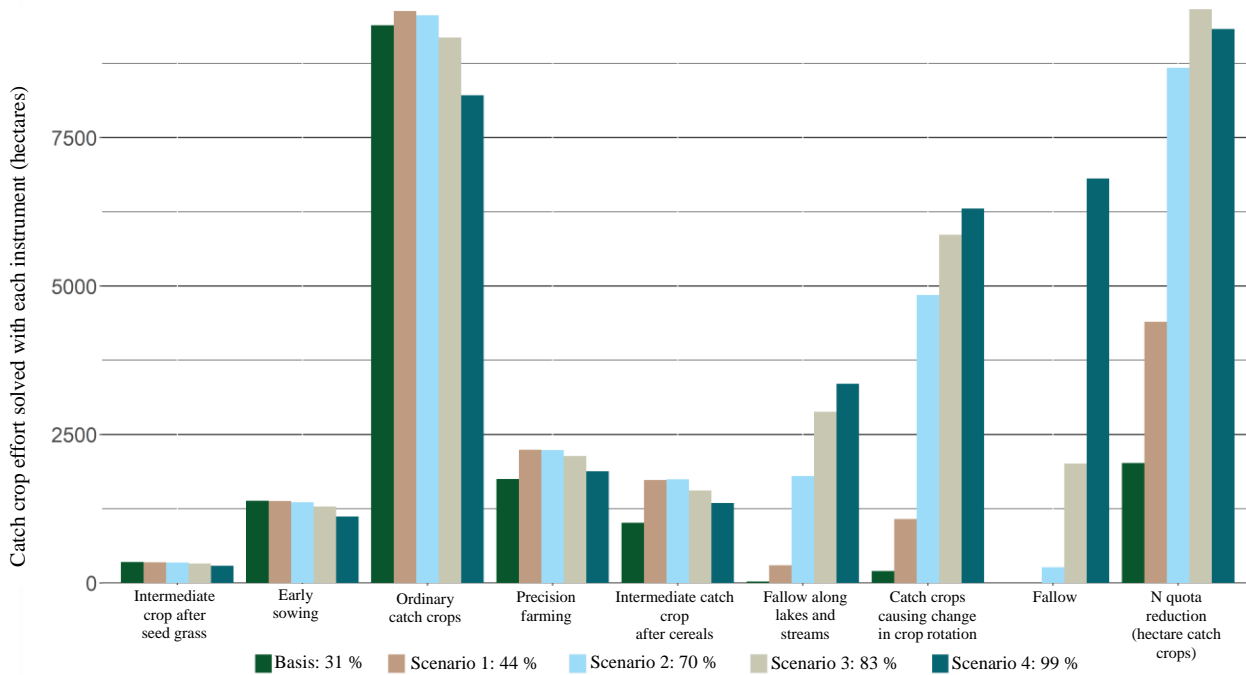

Figure 3. Distribution of instruments for different scenarios, catchment area of Odense Fjord, Seden Strand. Normal weighting of the annual effect of the instruments.

Figure 4 shows how the instruments are distributed when the weighting is changed to that which applies when seasonal variation is taken into account. Both examples are shown by uniform effort requirements calculated in percentage targeted catch crops out of the catch crop base area.

On the one hand, intermediate crops carry less weight when seasonal variations are taken into account. Therefore, a smaller part of the solution comes from intermediate crop after seed grass and intermediate crop after grain, when seasonal variation is taken into account. The same applies to early sowing, where Figure 3 uses slightly more than 1,250 ha of catch crop effect from early sowing, while Figure 4 reduces it to less than 1,200 ha. The ordinary catch crops on sandy soil have a greater weighting when seasonal variation is taken into account, therefore ordinary catch crops also solve a larger share of the effort. Precision agriculture is unchanged. The weighting of fallow along streams and lakes is also unchanged, but as the remedy is relatively expensive, there are also changes in this due to changes in the application of norm reduction. The norm reduction becomes significantly more expensive when seasonal variation is taken into account, primarily because the model does not distinguish between above and below 80 kg N from organic fertilizer, but simply applies a uniform rate of 175 kg N per hectare of catch crop.

This also has an impact on catch crops with crop rotation, which end up being more prevalent in the seasonal variation solution, while fallow will take up less space in scenario 4.

Distribution of instruments in various scenarios, coastal water Odense Fjord, Seden Strand

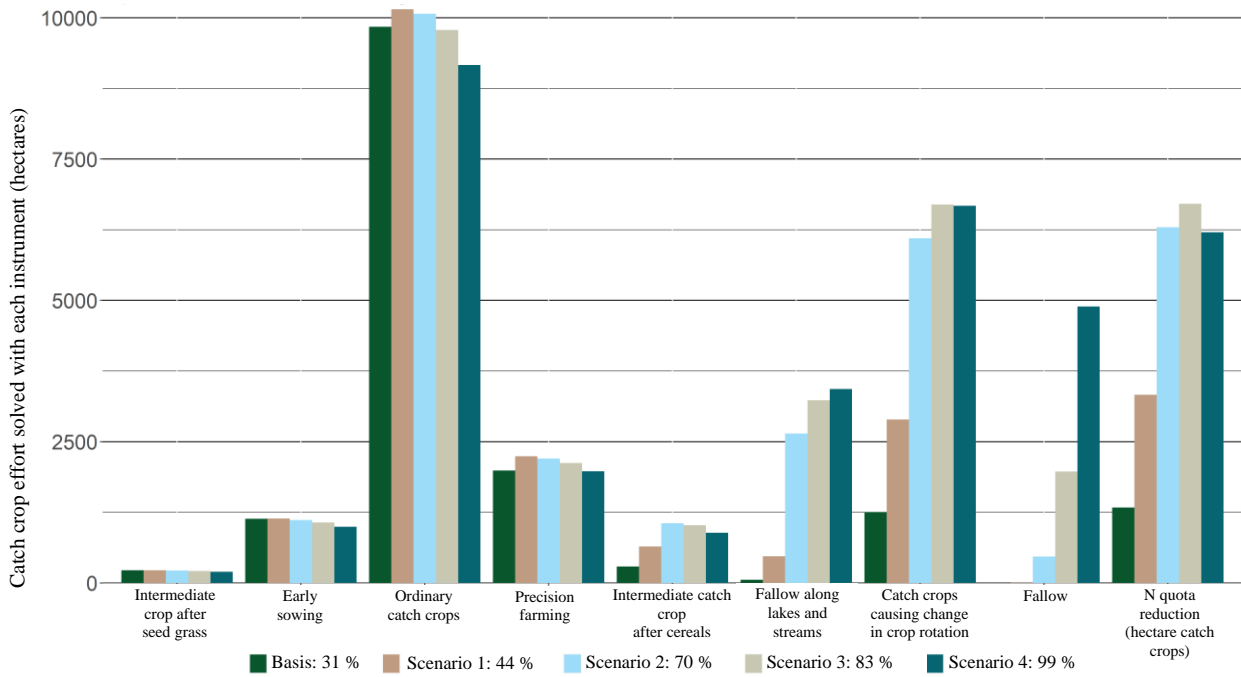

Figure 4. Distribution of instruments for different scenarios, catchment area of Odense Fjord, Seden Strand. Seasonal variation in weighting

Program for NordBalt Ecosafe workshop 7. november 2024:

Miljømål, overvåking, tiltak, virkemidler i eutrofe vassdrag

Forvaltning, brukerinteresser og forskning i samarbeid mot bedre vannkvalitet og god økologisk tilstand.



Sted: Thon hotell, Ski, møterom Holstad. Tid: torsdag 7. november 2024, kl 10:00-14:30.

Tid	Tema	Ansvarlig
Ordstyrer: Eva Skarbøvik, NIBIO		
10:00-10:20	Uformell samling i pausearealet med kaffe/te, croissanter, nøtter	
10:20-10:25	Velkommen og kort intro om Nord-Balt ECOSAFE	Anne Lyché Solheim
10:25-11:00	Miljømål for N og P i vann og effekten av klimaendringer Ved å benytte biologidata på tvers av nordiske land har vi beregnet miljømål for fosfor og nitrogen i nordiske vanntyper, herunder i leirvassdrag. Miljømålene er sammenlignet med eksisterende miljømål i de forskjellige landene. Vi vil vise hvor ulike slike miljømål kan være mellom land for vannforekomster som tilhører samme vanntype. Vi sammenligner nåværende miljømål med de nye beregningene. Vi har også vurdert klimaeffekter på biologien, som grunnlag for diskusjonen. <u>Mentimeter og diskusjon:</u> Bør de norske miljømålene endres? Vil klimaendringene tilsa strengere eller slappere miljømål for næringssalter?	Anne Lyché Solheim og Jan-Erik Thane, NIVA
11:00-11:30	Hva forteller modeller om effekter av tiltak og klimaendringer? Modeller kan benyttes til å vurdere effekten av klimaendringer og miljøtiltak på vannføring og vannkvalitet: Hvilke foreløpige resultater har vi fra modelleringen i Vannområde Morsa? <u>Diskusjon:</u> Hva tror dere om våre foreløpige resultater, er dette gjenkjennbart? Hvilke scenarier ønsker dere at vi modellerer?	Csilla Farkas, NIBIO
11:30-12:30	Lunsj	

Ordstyrer: Anne Lyche Solheim, NIVA		
12:30-13:15	<p>Bruk av sensorer til å beregne usikkerhet av stikkprøver, og til å engasjere.</p> <p>Turbiditets-sensorer kan brukes som en erstatning for vanlige analyser av fosfor og partikler i vannprøver. Dette har gitt oss mulighet til å vurdere usikkerheten av stikkprøver tatt hver uke, 14. dag, og måned. Vi har også sendt ut informasjon til forvaltning og bønder om sanntidsdata av turbiditet i Kråkstadelva og Skuterudbekken, se: www.nibio.no/sensor</p> <p><u>Mentimeter og diskusjon:</u> Hva kan vi godta av usikkerhet? Kan sanntids sensor-data motivere til mer engasjement hos lokalbefolkning om å beskytte vannet?</p>	Eva Skarbøvik, NIBIO
13:15-13:45	<p>Tiltak (og virkemidler) virker!</p> <p>Vi viser eksempler på forbedring av vannkvalitet i eutrofe vassdrag fra landene som deltar i ECOSAFE. Hvilke tiltak, og økonomiske og juridiske virkemidler ligger bak disse forbedringene? Vi har også en ny forskrift om regionale miljøkrav i jordbruket for Oslo og Viken.</p> <p><u>Diskusjon:</u> Er den nye forskriften med regionale miljøkrav (se lenke nederst) det som skal til for å nå miljømålene? Må det flere virkemidler til for å beskytte vannkvalitet og biodiversitet i det nåværende og kommende klimaregimet</p>	Eva Skarbøvik, NIBIO
13:45-14:00	Kaffepause	
14:00-14:25	<p>Hvordan kan vi sammen løse utfordringene for å redusere eutrofiering og nå miljømålene?</p> <p>Oppsummerende diskusjon og idédugnad.</p> <p>Vi plukker opp diskusjonstema som vi ikke fikk nok tid til, og kjører en idédugnad om forsknings- og informasjonsbehov sett fra forvaltningens og brukergruppens side.</p>	Ledes av Eva Skarbøvik Alle deltagere oppfordres til å bidra
14:25-14:30	Veien videre – noen korte ord som avslutning.	NIBIO og NIVA

Noen lenker til relevante nettsider:

- ✓ ECOSAFE sin nettside (engelsk): <https://projects.au.dk/nordbalt-ecosafe>
- ✓ Infoark om miljømål (engelsk): (Trykk på den andre blå boksen, sett ovenfra, på denne nettsiden): <https://projects.au.dk/nordbalt-ecosafe/wp1>
- ✓ NIBIOs nettsider om sensorovervåking, og med egen temaartikkel om Kråkstadelva og Skuterudbekken: <https://www.nibio.no/tema/miljo/vannovervaking/sensorovervaking-med-sanntids-data> (der finnes også et norsk infoark om sensorer); og www.nibio.no/sensor
- ✓ Forskrift om regionale miljøkrav i jordbruket, Oslo og Viken: <https://lovdata.no/dokument/LF/forskrift/2022-12-06-2182>

Deltagere påmeldt til Nord-Balt ECOSAFE Norsk stakeholder workshop 7.11.2024

Nr.	Navn	Forvaltnings nivå
1	Maria Bislingen	Vannområde
2	Knut Bjørnskau	Vannområde
3	Anita Borge	Vannområde
4	Heidi Engelhardt-Bergsjø	Regional
5	Helen Gabestad	Regional
6	Pernille Andrine Eriksdatter Giske	Regional
7	Helga Gunnarsdottir	Nasjonal
8	Per Rønneberg Hauge	Regional
9	Carina Rossebø Isdahl	Vannområde
10	Marit Ness Kjeve	Vannområde
11	Bård Olav Kollerud	Vannområde
12	Kristian Moseby	Vannområde
13	Lars Kristian Selbekk	Vannområde
14	Arne Ivar Sletnes	Vannområde
15	Asbjørn Veidal	Nasjonal

Deltagere fra NIBIO og NIVA:

Navn	Institutt
Eva Skarbøvik	NIBIO
Anne-Grete Buseth Blankenberg	NBIO
Csilla Farkas	NIBIO
Anastasija Isidorova	NIBIO
Jan-Erik Thrane	NIVA
Anne Lyche Solheim	NIVA

Innledning om NORDBALT ECOSAFE prosjektet

- EU-prosjekt om “**safe nutrient management**” i jordbruksområder i Norden og sentral-Europa
- Koordinator Århus Universitet (AU), Danmark
- Partnere fra Norge (NIVA & NIBIO), Sverige (SLU), Finland (SYKE), Latvia (LLU), Polen (SSGW)
- Varighet: 3 år fra Sept 2022 til August 2025

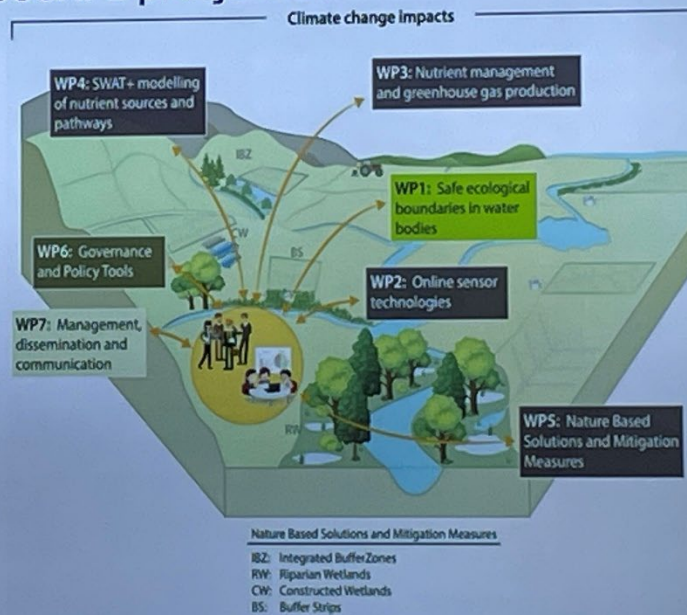

NIVA



Program for NordBalt Ecosafe workshop om: Miljømål, overvåking, tiltak og virkemidler i eutrofe vassdrag

Forvaltning, brukerinteresser og forskning i samarbeid mot bedre vannkvalitet og god økologisk tilstand

Tid	Tema
10:20-10:25	Velkommen og kort intro om workshopen og Nord-Balt ECOSAFE prosjektet
10:25-11:00	Miljømål for N og P i vann og effekten av klimaendringer
11:00-11:30	Hva forteller modeller om effekter av tiltak og klimaendringer?
11:30-12:30	<i>Lunsj</i>
12:30-13:15	Bruk av sensorer til å beregne usikkerhet av stikkprøver, og til å engasjere
13:15-13:45	Tiltak (og virkemidler) virker!
13:45-14:00	<i>Kaffepause</i>
14:00-14:25	Idédugnad: Hvordan kan vi sammen løse utfordringene for å redusere eutrofiering og nå miljømålene?
14:25-14:30	Veien videre

Mål for workshopen:

- Formidle og diskutere resultater fra Nord-Balt ECOSAFE prosjektet
- Drøfte nytteverdien for forvaltning og andre brukergrupper i eutrofe vassdrag
- Dialog forvaltning - forskere for å diskutere behov for mer kunnskap

Ansvarlige:

Anne Lyche Solheim, (NIVA) & Eva Skarbøvik (NIBIO)

Presentasjon for Nord-Balt ECOSAFE stakeholder workshop nr. 2; 7. november 2024

Project: 101060020 — NORDBALT-ECOSAFE —
HORIZON-CL6-2021-ZEROPOLLUTION-01



Innledning om NORDBALT ECOSAFE prosjektet

- EU-prosjekt om “**safe nutrient management**” i jordbruksområder i Norden og sentral-Europa
- Koordinator Århus Universitet (AU), Danmark
- Partnere fra Norge (NIVA & NIBIO), Sverige (SLU), Finland (SYKE), Latvia (LLU), Polen (SSGW)
- Varighet: 3 år fra Sept 2022 til August 2025

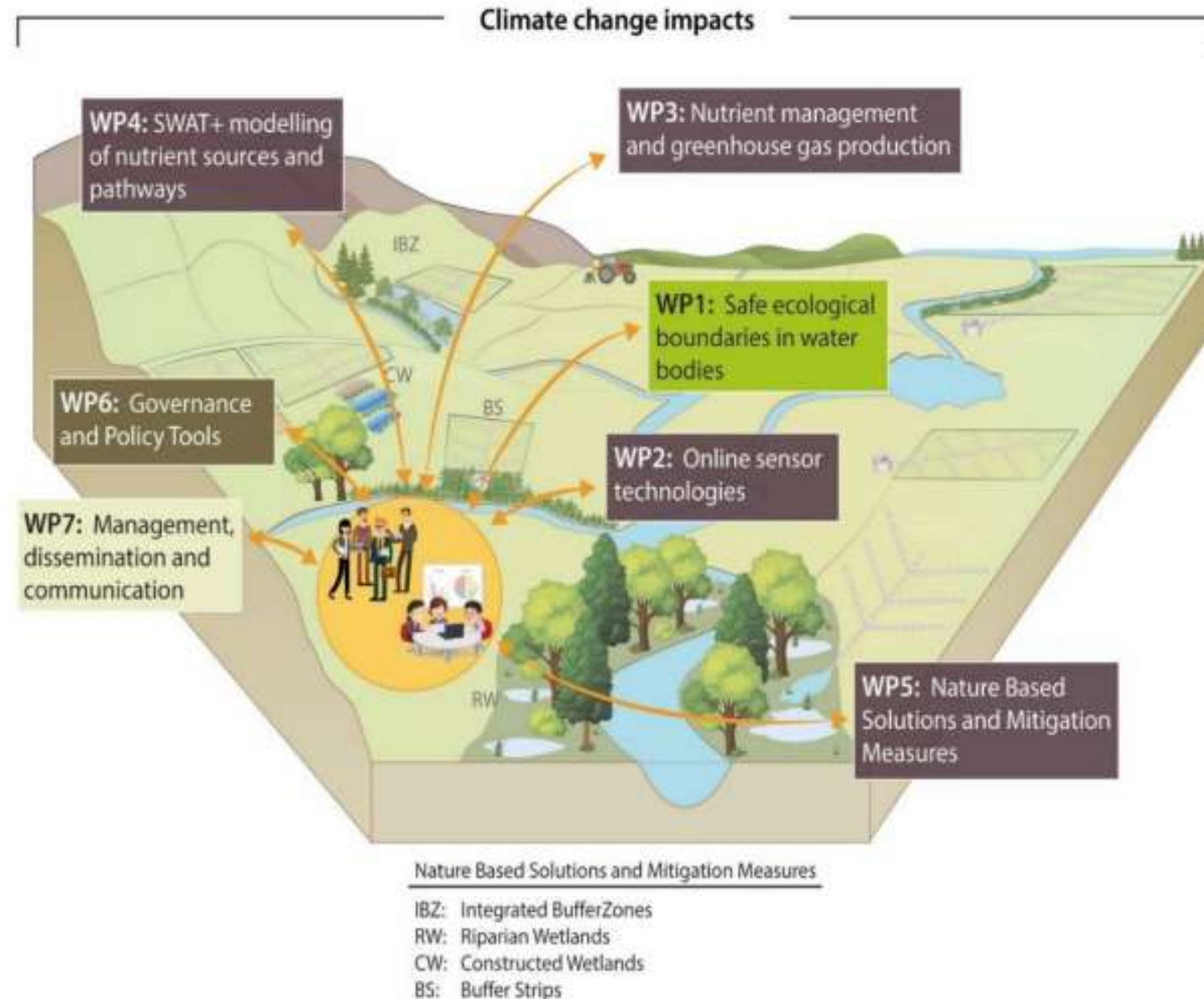

Demonstrasjons områder (WP4, 5, 6)

River Odense, Denmark	
Catchment area (km ²)	1050
Average precip. (mm/yr)	825
Mean temperature (°C)	8.4
Mean streamflow (mm)	313
Agriculture (%)	68
Forest (%)	10

River Hobøelva, Norway	
Catchment area (km ²)	337
Average precip. (mm/yr)	992
Mean temperature (°C)	7.2
Mean streamflow (mm)	496
Agriculture (%)	20
Forest (%)	70

River Örsundaån, Sweden	
Catchment area (km ²)	900
Average precip. (mm/yr)	607
Mean temperature (°C)	6.2
Mean streamflow (mm)	219
Agriculture (%)	35
Forest (%)	41

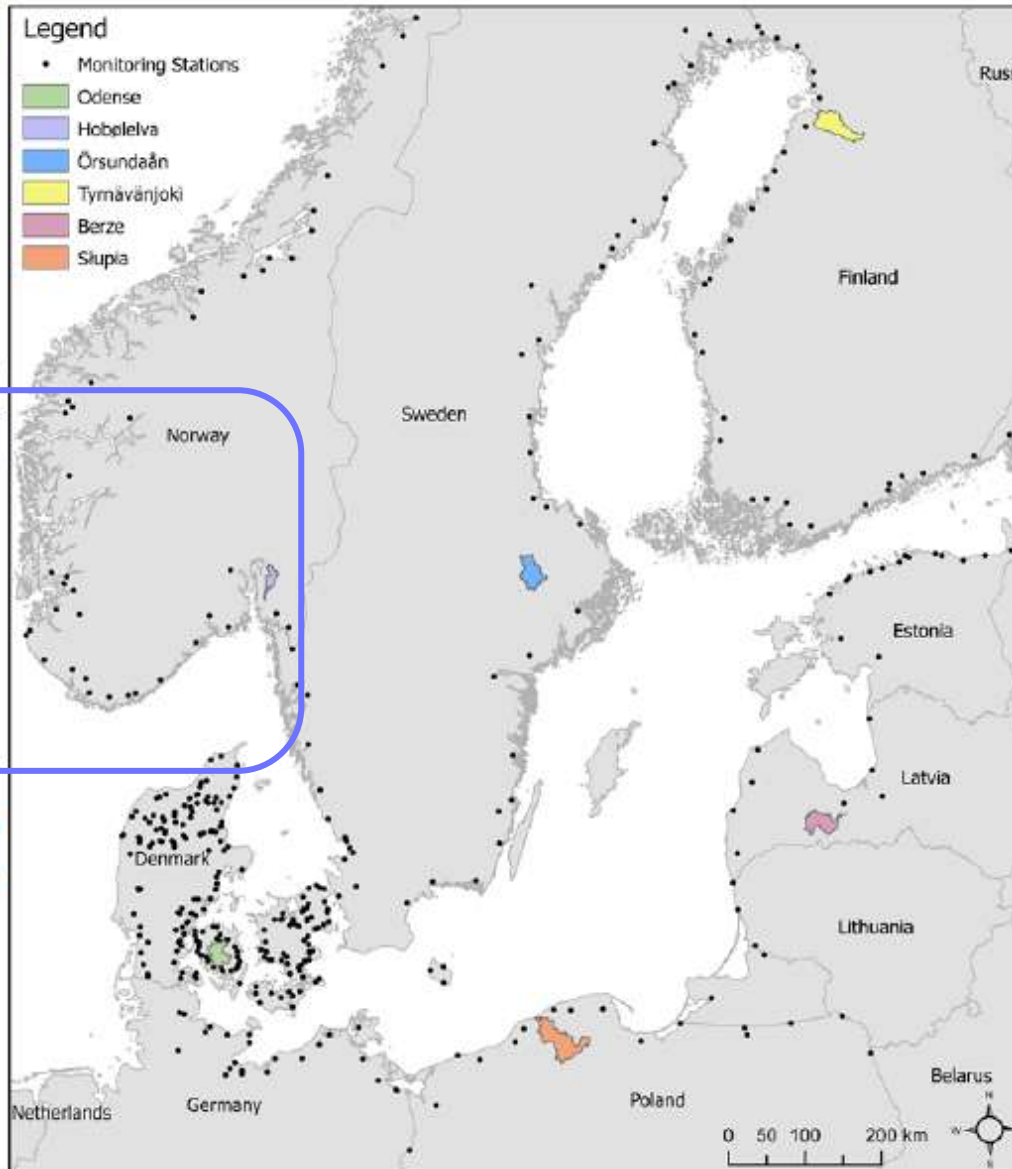

River Tynärvänjoki, Finland	
Catchment area (km ²)	1181
Average precip. (mm/yr)	477
Mean temperature (°C)	2.6
Mean streamflow (mm)	231
Agriculture (%)	15
Forest (%)	82

River Berze, Latvia	
Catchment area (km ²)	872
Average precip. (mm/yr)	573
Mean temperature (°C)	7.6
Mean streamflow (mm)	195
Agriculture (%)	56
Forest (%)	39

River Stupia, Poland	
Catchment area (km ²)	1623
Average precip. (mm/yr)	850
Mean temperature (°C)	7.0
Mean streamflow (mm)	330
Agriculture (%)	49
Forest (%)	44

WP1: Fastsetting av miljømål for næringsalter som sikrer god økologisk tilstand for biologien i jordbrukspåvirkede innsjøer og elver; inkludert vurdering av klimaeffekter

Anne Lyche Solheim, Jan-Erik Thrane, Areti Balkoni (NIVA), Kirstine Thiemer (NIVA & AU), Brian Kronvang (AU), Jens Fölster (SLU), Jukka Aroviita (SYKE), Ainis Lagzdins (LV), Ignacy Kardel (PL)

Presentation for Nord-Balt ECOSAFE 2nd stakeholder workshops høsten 2024

Prosjekt: 101060020 — NORDBALT-ECOSAFE —
HORIZON-CL6-2021-ZEROPOLLUTION-01



Bakgrunn:

- Grenseverdier (god/moderat) rapportert fra landene til EU/EEA med 2. runde forvaltningsplaner i 2016 viser at mange av disse er altfor høye til å kunne gi god tilstand for biologien i innsjøer og elver.
- Normalt intervall for biologisk respons på fosfor er 10-100 µg/L
- Figurene viser grenseverdiene aggregert til forskjellige vanntyper.

Innsjøer

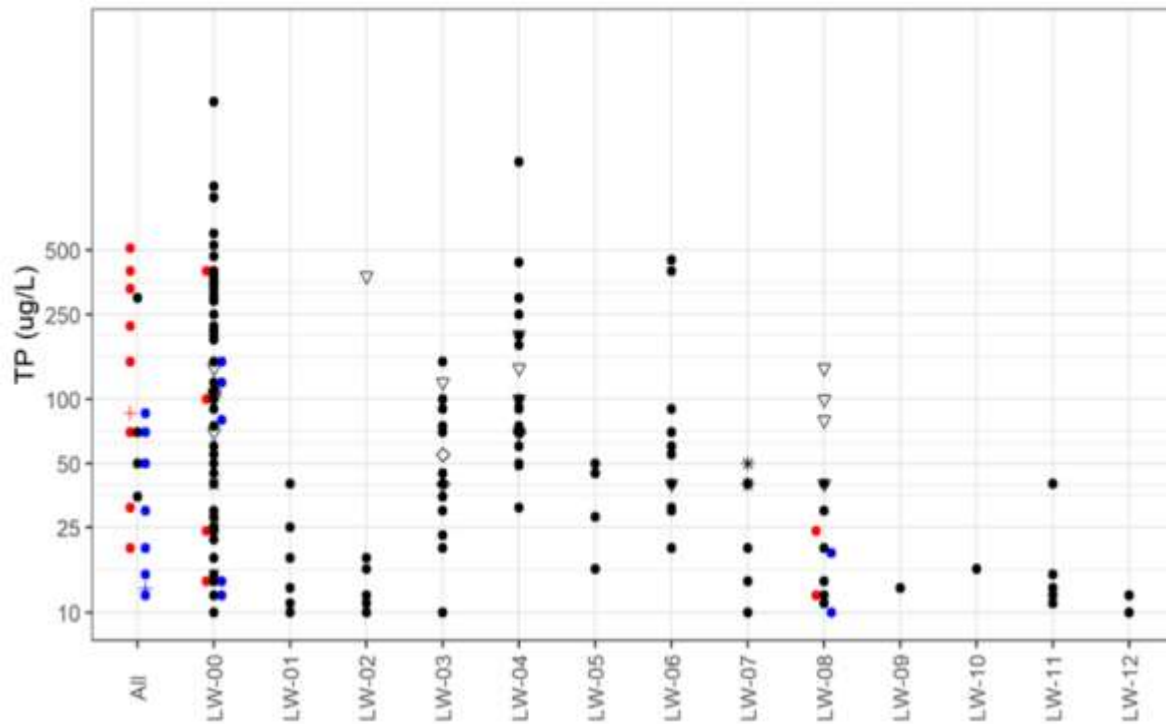

Elver

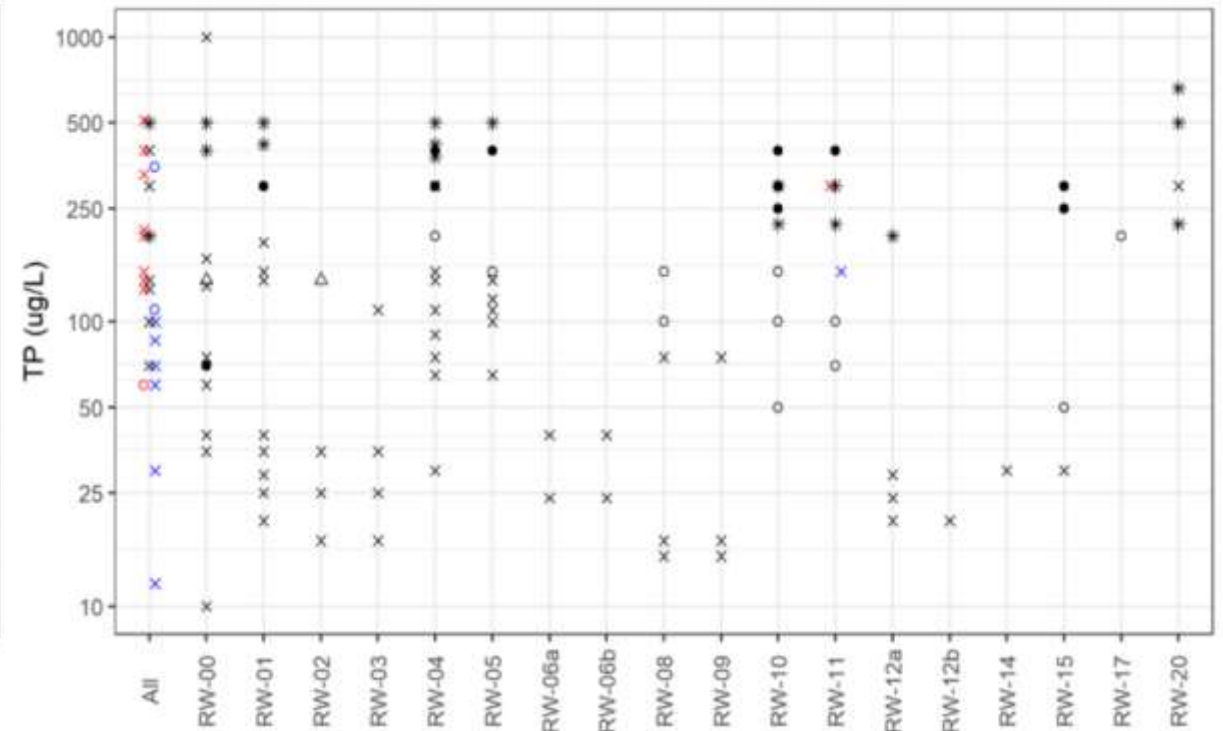

Datsett for felles vanntyper (IC type) i Nord-Balt ECOSAFE landene:

Innsjøer planteplankton

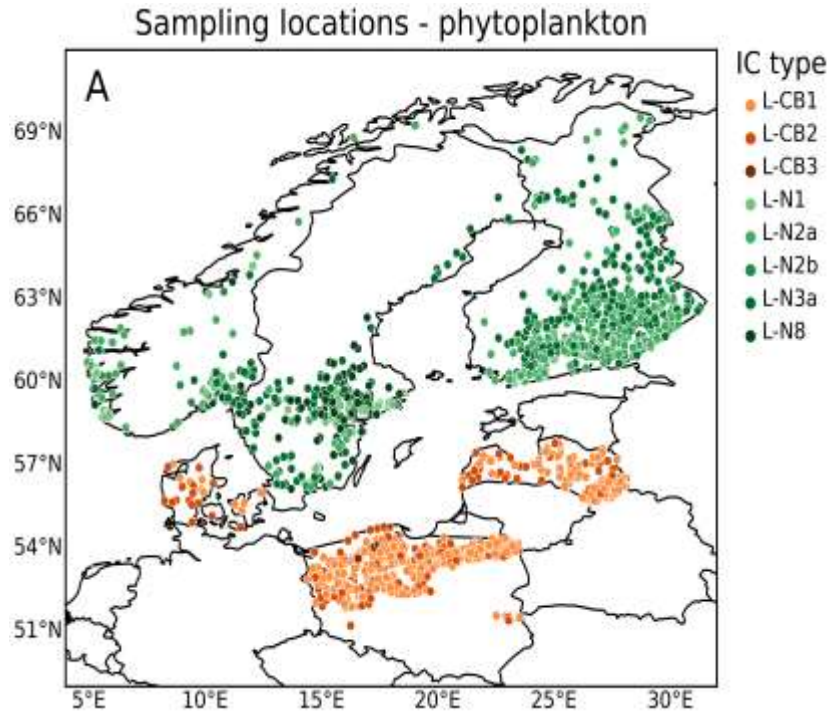

Elver begroingsalger

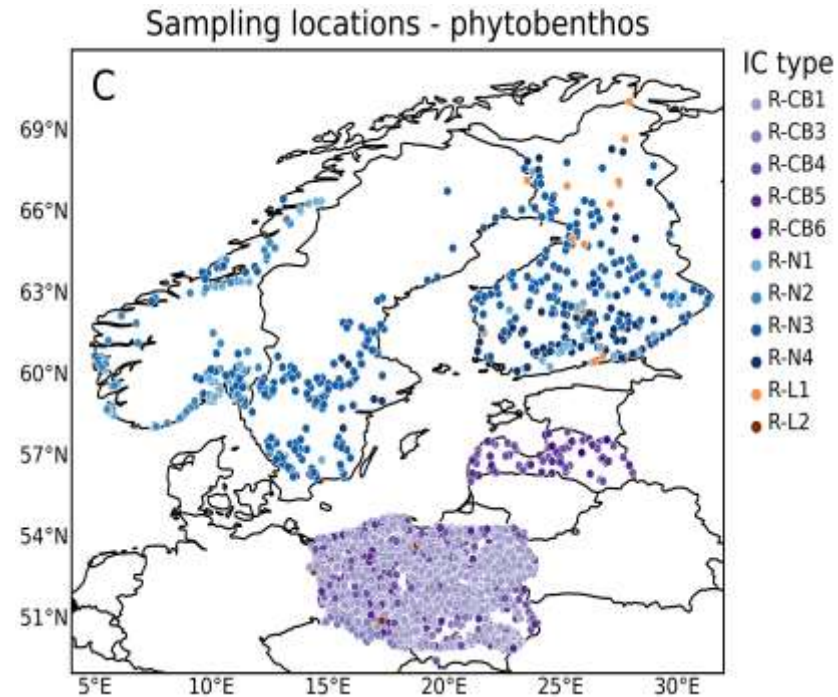

+ konsentrasjoner av Tot-P og Tot-N for alle vannforekomster med biologi-data konvertert til normaliserte EQR-verdier (nEQR)

Metodikk brukt for å estimere miljømål (GM-grensen) som vil gi god økologisk tilstand for biologien (BQEs), f.eks. begroingsalger

IC type R-N3 "Small/medium, lowland, organic, low alkalinity"

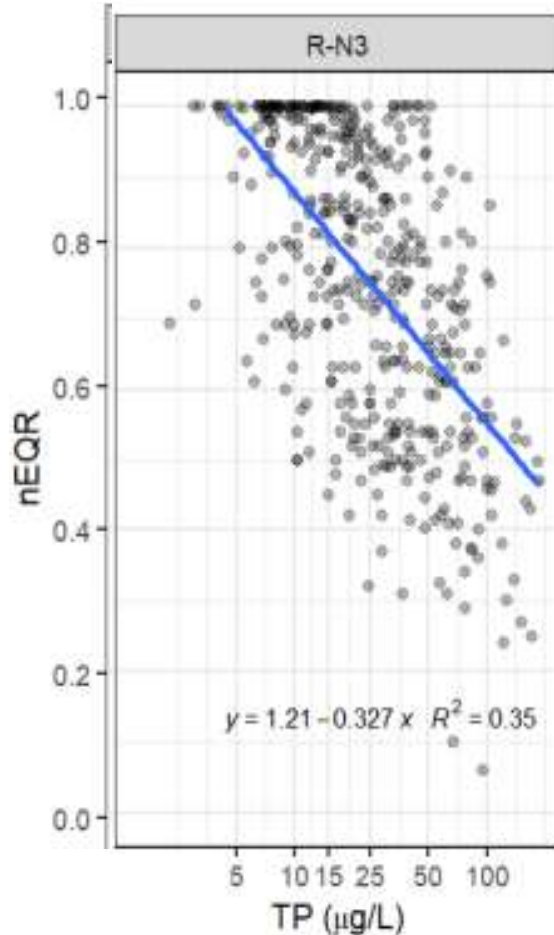

- Binomial logistisk regresjon (BLR), som konverterer nEQR-verdiene for BQEs til sannsynlighet for god tilstand (EQR > 0.6) eller ikke god tilstand (EQR < 0.6)
- Robust metode som håndterer statistiske uoverensstemmelser mellom næringsstoffer (f.eks. Tot-P) og nEQR-verdier
- Anbefalt av WFD CIS-ECOSTAT, inkludert i ny versjon av CIS-Best Practice Veileder

TP vs phytobenthos nEQR					
Nordic river type	Country datasets	Total # WBS	Metric	GM boundary (µg/L)	probability of good
R-N3: Lowland, siliceous, humic rivers	FI=175, NO=116, SE=151	442	Kappa	38 [33-46]	0,66
			Omis =Comm	31 [26-36]	0,73
			FNR=FPR	44 [38-53]	0,61



BLR-metodikken er publisert av Phillips et al., 2023:
<https://doi.org/10.1016/j.scitotenv.2023.168872>

BLR resultater og sammenligning med nåværende miljømål: for Tot-P i Nordiske innsjøtyper



Total Phosphorus ($\mu\text{g L}^{-1}$)

Nordic region

Lowland types

NGIG type		L-N1	L-N2a	L-N3a	L-N8
Type description		moderate alkalinity, non-humic, stratified	low alkalinity, non-humic, stratified	low alkalinity, humic, stratified	moderate alkalinity, humic, stratified
BQE used for modelling		Phytoplankton	Phytoplankton	Phytoplankton	Phytoplankton
modelled GM boundaries	mean	14	14	19	24
	conf.limits	11-17	12-15	17-20	20-29
	r2	0.74	0.56	0.64	0.45
	prob good	0.55	0.79	0.76	0.48
	N (# WBs)	63	394	453	110
current GM boundaries	NO	17	11	16	20
	SE	14	12	18	19
	FI	na	18	28	na

Nåværende grenseverdier i gult trenger validering med ECOSTAT toolkit (Shiny App)

BLR resultater og sammenligning med nåværende miljømål: for Tot-N i Nordiske innsjøtyper

Total Nitrogen ($\mu\text{g L}^{-1}$)

Nordic region

Lowland types

NGIG type		L-N1	L-N2a	L-N3a	L-N8
Type description		moderate alkalinity, non-humic, stratified	low alkalinity, non-humic, stratified	low alkalinity, humic, stratified	moderate alkalinity, humic, stratified
BQE used for modelling		Phytoplankton	Phytoplankton	Phytoplankton	Phytoplankton
modelled GM boundaries	mean	537	428	511	681
	conf.limits	189-927	380-475	472-551	588-782
	r2	0.21	0.36	0.36	0.37
	prob good	0.53	0.81	0.77	0.52
	N (# WBs)	63	394	453	109
current GM boundaries	NO	675	475	650	775
	SE	na	na	na	na
	FI	na	500	660	na

Nåværende grenseverdier i gult trenger validering med ECOSTAT toolkit (Shiny App)

BLR resultater og sammenligning med nåværende miljømål: for Tot-P i Nordiske elvetyper



Total Phosphorus ($\mu\text{g L}^{-1}$)

Nordic region

Lowland types

	NGIG type	R-N1	R-N3	R-N4	Clay rivers
	Type description	moderate alkalinity, non-humic, small	low alkalinity, humic, small-medium	moderate alkalinity, non-humic, medium	clay cover mean 43% (stdev. 20-70%)
	BQE used for modelling	Phytobenthos	Phytobenthos	Phytobenthos	Benthic inverts
	mean	17	31	24	45
	conf. limits	12-24	26-36	10-39	33-60
	r ²	0.53	0.35	0,11	0.27
	prob good	0.76	0.73	0.86	0.40
	N (# WBs)	143	442	96	135
	current GM	25	24	25	40-80
	SE	21 ¹	20-23	20	na
	FI	35	40	35	60

Resultater for leirelver er i overensstemmelse med resultatene i Skarbøvik & Schneider, 2023, som var basert på begroingsalger (phytobenthos)

¹ Includes larger and mid-altitude rivers

Nåværende grenseverdier i gult trenger validering med ECOSTAT toolkit (Shiny App)

Norske leirvassdrag: datasett og BLR korrelasjon med bunndyr

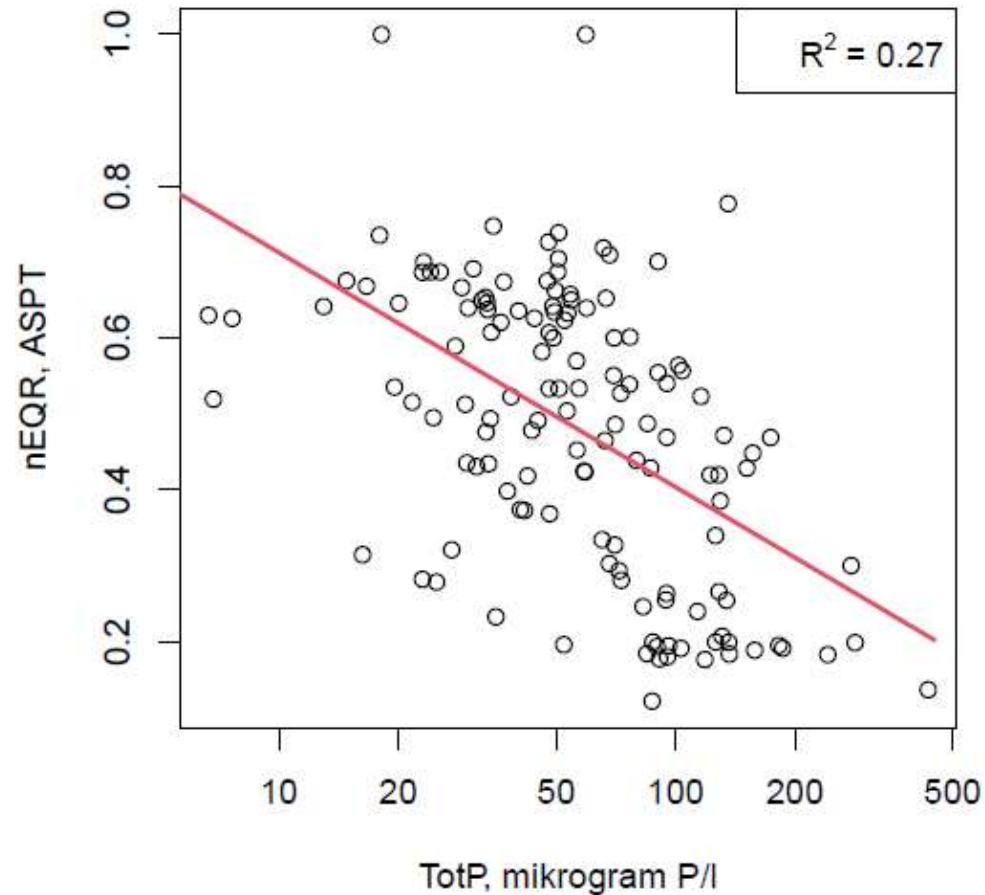

Kun data fra Norge, 135 vannforekomster

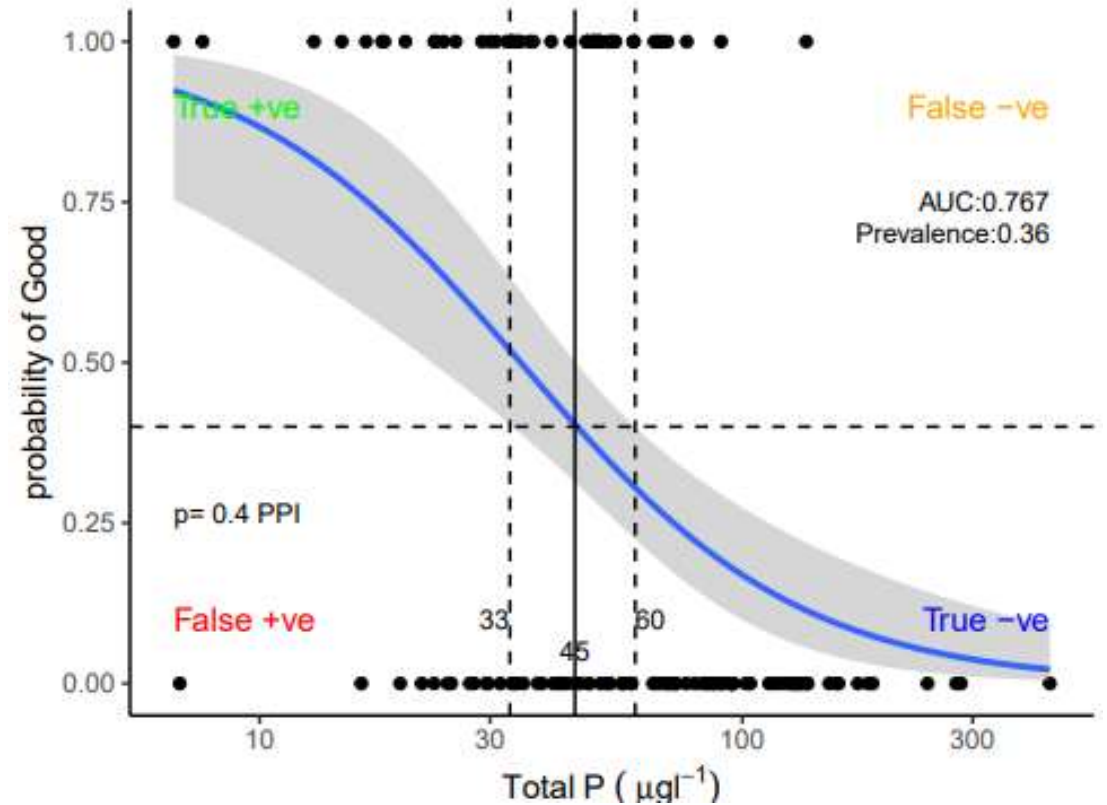

Estimerte GM grenseverdier for Tot-P:
45 (33-60) $\mu\text{g L}^{-1}$

BLR resultater og sammenligning med nåværende miljømål: for Tot-N i Nordiske elvetyper

Total Nitrogen ($\mu\text{g L}^{-1}$)
Nordic region

		Lowland types			
NGIG type		R-N1	R-N3	R-N4	Clay rivers
Type description		moderate alkalinity, non-humic, small	low alkalinity, humic, small-medium	moderate alkalinity, non-humic, medium	clay cover mean 40% (20-70%)
BQE used for modelling		Phytobenthos	Phytobenthos	Phytobenthos	Benthic inverts
modelled GM boundaries	mean	592	732	na	na
	conf.limits	405-800	629-829	na	na
	r2	0.51	0.25	na	na
	prob good N (# WBs)	0.81 133	0.80 420	na	na
current GM boundaries	NO	675	650	675	na
	SE	na	na	na	na
	FI	800	900	800	na

Nåværende grenseverdier i gult trenger validering med ECOSTAT toolkit (Shiny App)

Hva forteller resultatene om de eksisterende grenseverdiene?

- OK for de fleste vanntypene
- Men for høye for flere vanntyper i Finland
- De norske grenseverdiene kan være for høye for:
 - Tot-N i humøse, kalkfattige innsjøer,
 - Tot-P i leirelver med > 40% leirdekning

Hvordan kan resultatene brukes til å beregne akseptable tilførsler av næringsalter og til å planlegge/justere tiltak?

Nye modeller kan:

- konvertere miljømålene til akseptable tilførsler til vannforekomster i de utvalgte demonstrasjons-områdene.
- brukes til å estimere dagens tilførsler fra forskjellige kilder.
- planlegge flere tiltak hvis dagens tilførsler overskrider de akseptable tilførslene.
- Slike modeller presenteres i neste post på programmet

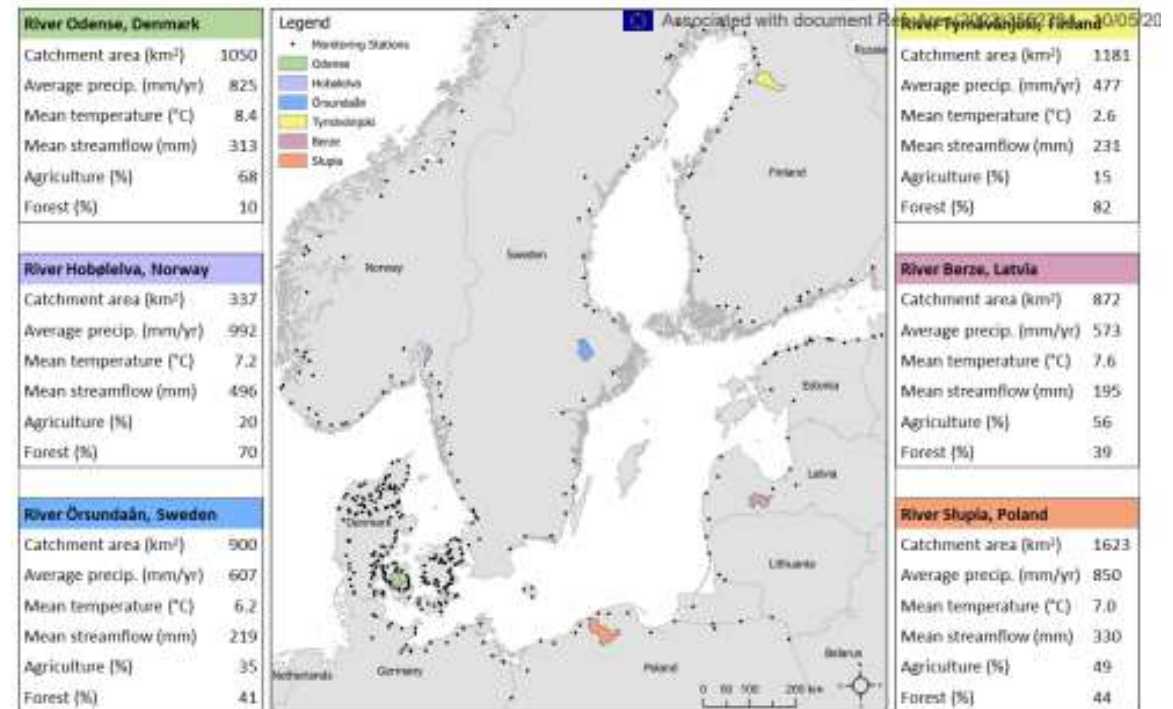

Så til slutt: Hvordan virker klimaendringer på biologien?

Nøkkel-spørsmål:

- Vil klimaendringer gjøre biologien mer følsom eller mindre følsom for næringsalter?
 - mer følsom pga varmere vann og mindre oksygen?
 - eller mindre følsom pga mer humus og leirpartikler (=dårligere lysforhold), samt økt vannføring?
- Bør miljømålene justeres pga klima-effekter på biologien?

Hvilke klimadata har vi brukt til å estimere effektene?

Kilde: Copernicus European Observation dataset (E-OBS) for samme tidsperiode og hver vannforekomst med data for næringsalter og EQR-verdier

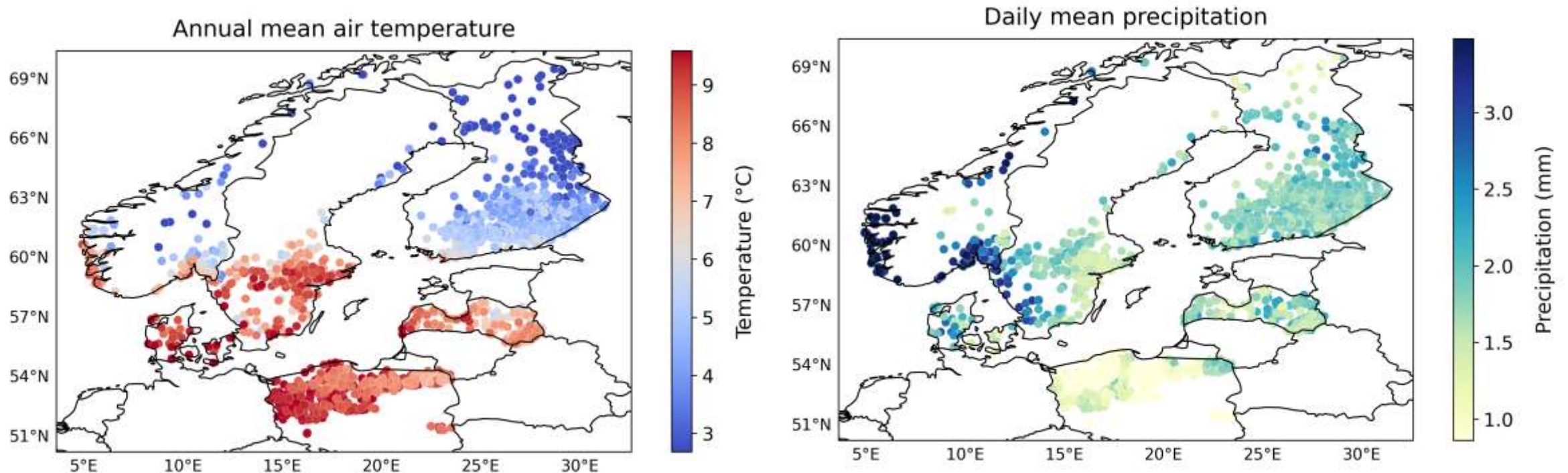

Eksempler på klimavariabeler som er brukt i modelleringen av klimaeffekter på biologien. Mange flere klimavariabeler er også lastet ned og kan brukes hvis de indikerer en effekt på EQR-verdiene

Foreløpige resultater: eksempel for nordiske humøse innsjøer

- Modell: Generalized linear mixed models (GLMMs)
 - **Økende nedbør og temperatur kan redusere økologisk tilstand for planteplankton**
 - Men effekten av klima er mye mindre enn effekten av Tot-P på EQR-verdiene.

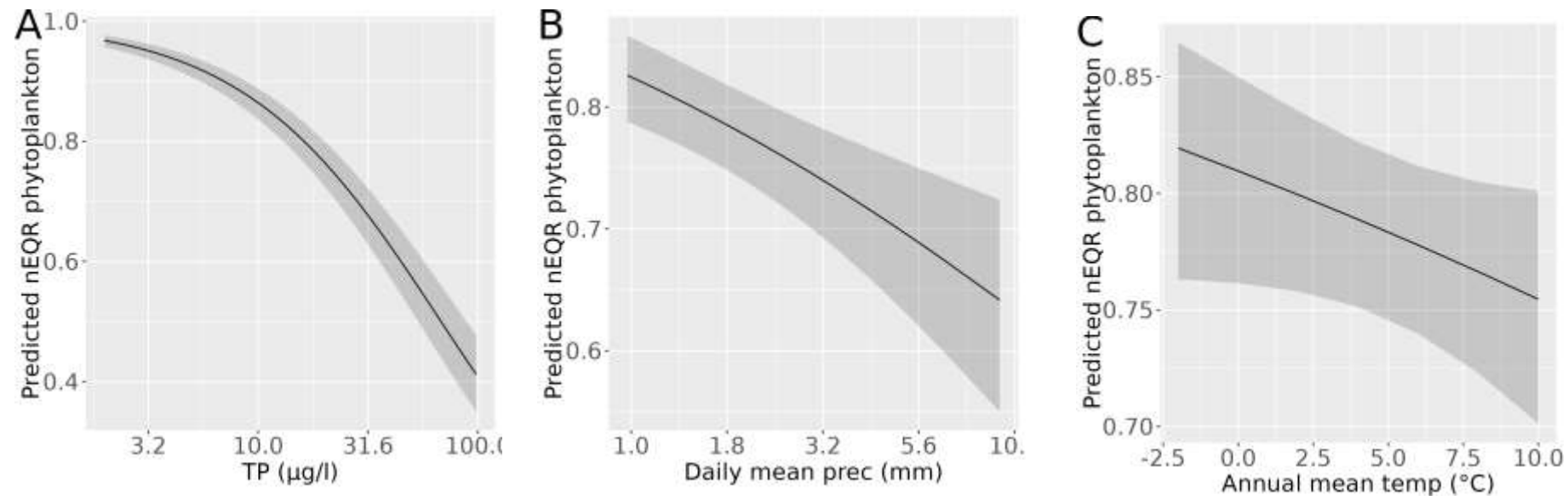

Gjenstående arbeid: Modelling av interaktive effekter av både Tot-P og klimavariabeler på EQR-verdiene. Testing av andre klimavariabeler, f.eks. klima i vekstsesongen, ekstremnedbør, ekstremtemperatur (flom, tørke, varmebølger)

Publisering av resultater til våren 2025:

- Vitenskapelig artikkel
- Policy brief /Fakta-ark

Takk til:

- Geoff Phillips (JRC consultant) for BLR kursing av NIVAs team i prosjektet
- EU finansiering:
 - Prosjekt: 101060020 — NORDBALT-ECOSAFE — HORIZON-CL6-2021-ZEROPOLLUTION-01

Overvåke med sensor

1. Hvor usikkert er det å ta stikkprøver med ukes-, 14. dg, -måneds mellomrom? Hvor stor usikkerhet aksepterer dere?
2. Hva tror dere om å ha sanntidsdata av vannkvalitet tilgjengelig på nett?

Team sensor:



Eva Skarbøvik
Prosjektleder,
rotekopp



Anastasija
Isidorova
Beregninger,
statistikk,
ordensmenneske



Robert Kozera Kari-Anne Dingsstad
Teknikere: Utsetting og ukentlig
vedlikehold av sensorer, hente
vannprøver til kalibrering
..og deres vikarer...



Anne-Grete Buseth
Blankenberg:
Sensorer inn og ut
av fangdammer



Jonathan Rizzi
Teknikk:
sanntidsdata på
nettsidene

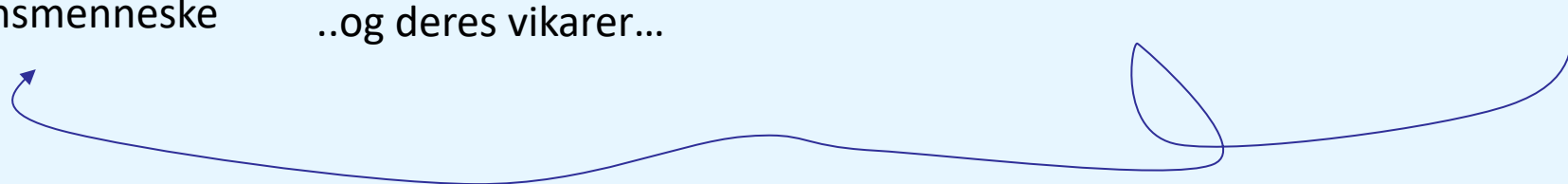

Eksempler på data i dette prosjektet

- › Kråkstadelva
- › Skuterud
- › (Mørdre)

Sanntidsdata fra sensorer i bekker



Kråkstadelva Trånsområde Moss. Foto: Eva Skarbovik.

PUBLISERT: 06.05.2024

KONTAKTPERSON



Eva Skarbovik

Seniorforsker - Divisjon for miljø og naturressurser

+47 416 20 622

eva.skarbovik@nibio.no

Kontorsted: Ås - Bygg 043

Lenker

[Skuterudbekke: turbiditet og vannhøyde](#)

[Kråkstadelva](#)



Faktaark om sensorovervåking

Informasjon om sensorer brukt i elver og bekker
3,005 MB pdf

Hvordan står det til i bekken?

De som bor i nærheten av en bekk har nok lagt merke til at bekken ikke alltid ser likedan ut. Som den greske filosofen Heraklit sa for to og et halvt tusen år siden: Du kan ikke gå ned i den samme elva to ganger! Med det mente han at elva hele tiden forandrer seg.

I Norge er elvene gjerne islagte om vinteren, så kommer våren med snøsmelting og høy vannføring, deretter kommer kanskje en tørt sommer med lav vannføring, før høststormene påny gi økt vannføring. I bekkene skjer slike endringer både oftere og raskere enn i elver. Nedbørfeltet til en bekk er lite, og en kraftig regnvevsepisode kan forvandle en stilleflytende bekk til frådende vannmasser på bare noen timer.

Derfor overvåker NIBIO enkelte bekker så ofte som hver halvtime. Dette gjøres med sensorer, og på denne siden kan du følge med på vannkvaliteten i to jordbruksbekker i Akerhus fylke: Kråkstadelva og Skuterudbekken. Data oppdateres hver dag klokken 9:00.

Vi legger ut disse data for at forvaltere, bønder og andre i nabolaget kan følge med på hva som skjer i 'nabolags-bekken'.

Til venstre på denne siden finner du [faktaark om sensorer](#).

Hva måler sensorene våre?

Men også fra de andre nordiske landene... når sensorene virker da...

NORDBALT
ECOSAFE

Nordbalt Ecosafe

- › Deliverables
- › About
- › Consortia
- › Dissemination
- › Regional meetings
- › News

Sensor monitoring

What are sensors? +



Real-time data from our interactive map +

Watch up: Our real-time data are not yet quality controlled +

Link to sensor stations in Denmark

- › Floendrup Bæk, Denmark: <https://www.au.dk/bioinformatics/frames.html>
- › Vejle Å, Haraldskær, Denmark: <https://www.au.dk/haraldskaer/box.html>

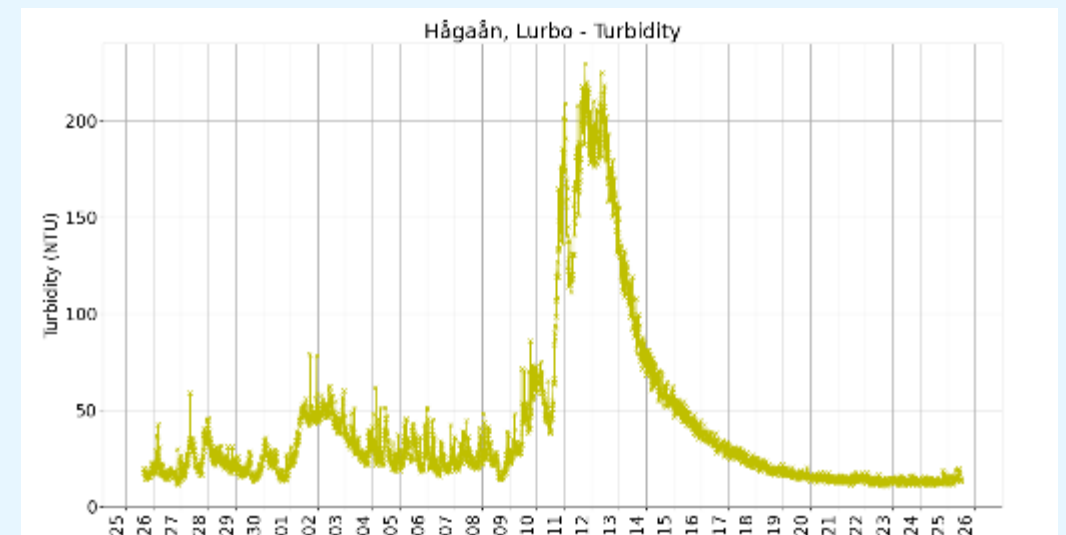
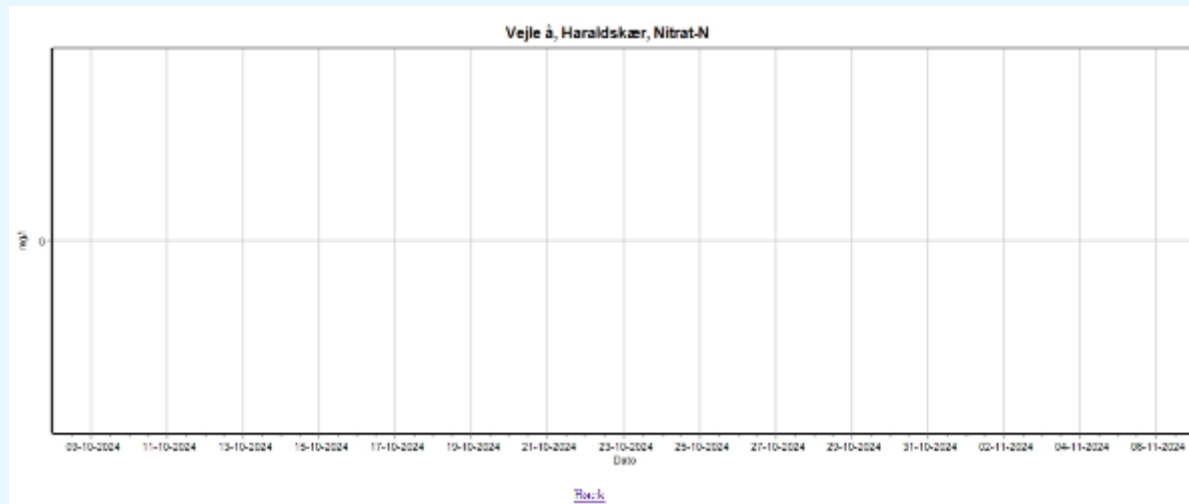
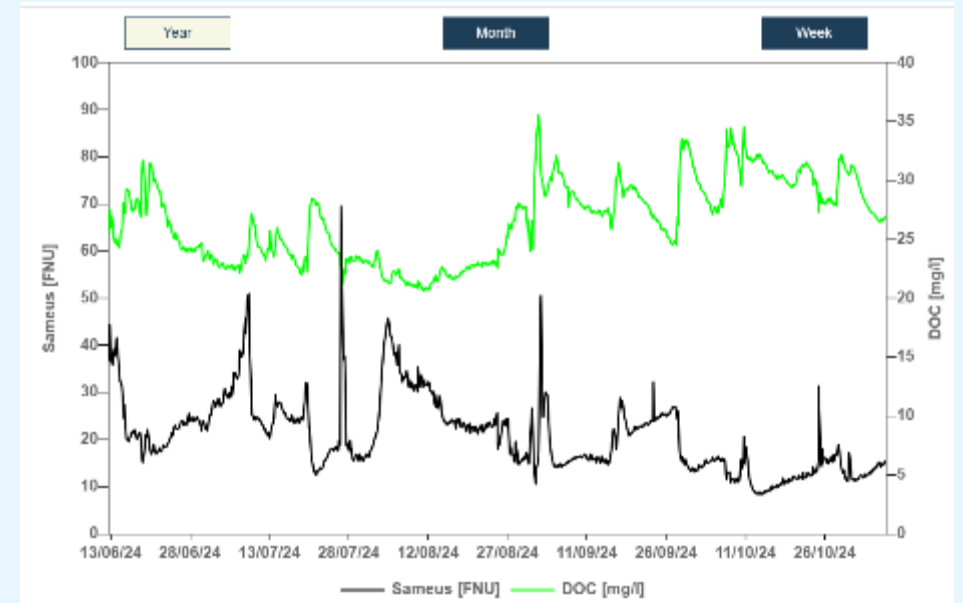
Different sensor data



Skuterud

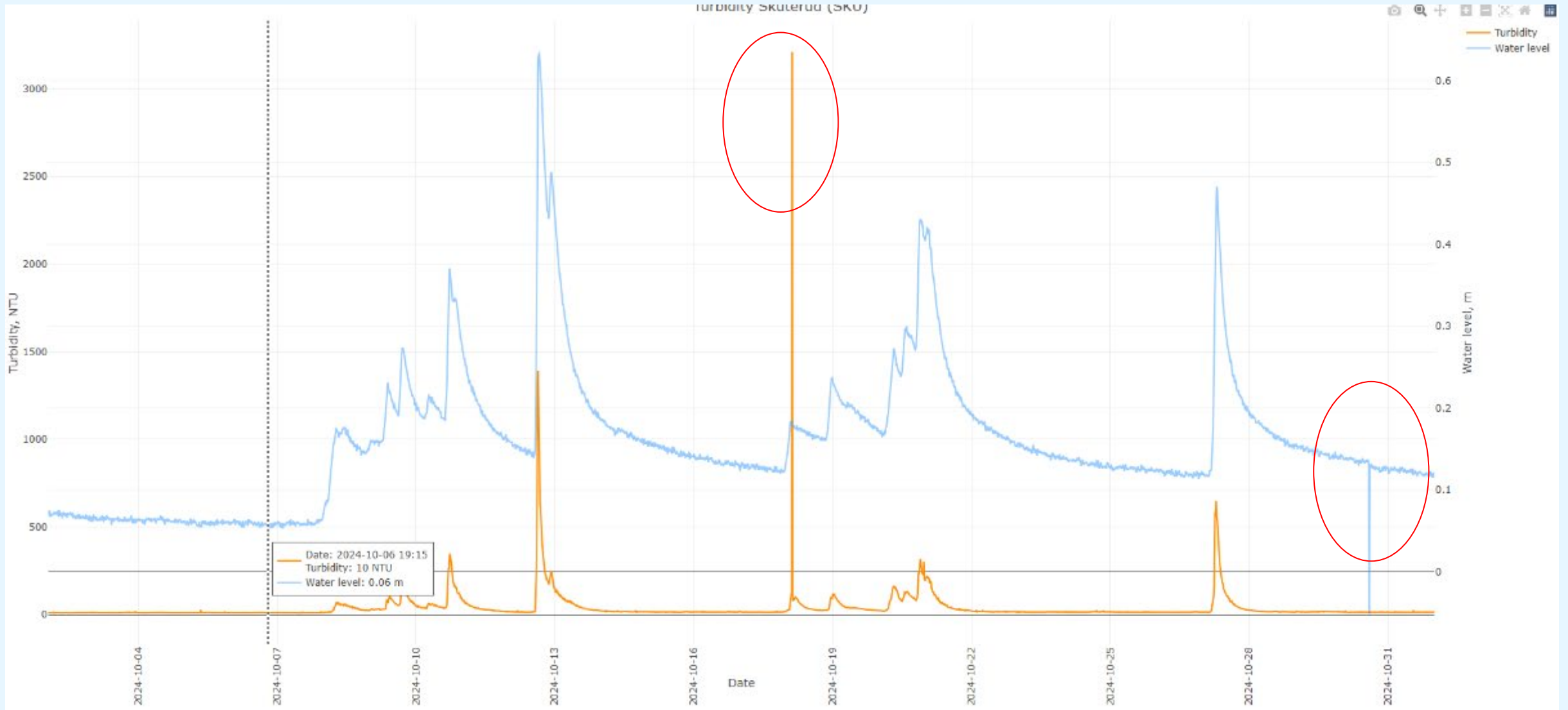

Kråkstad

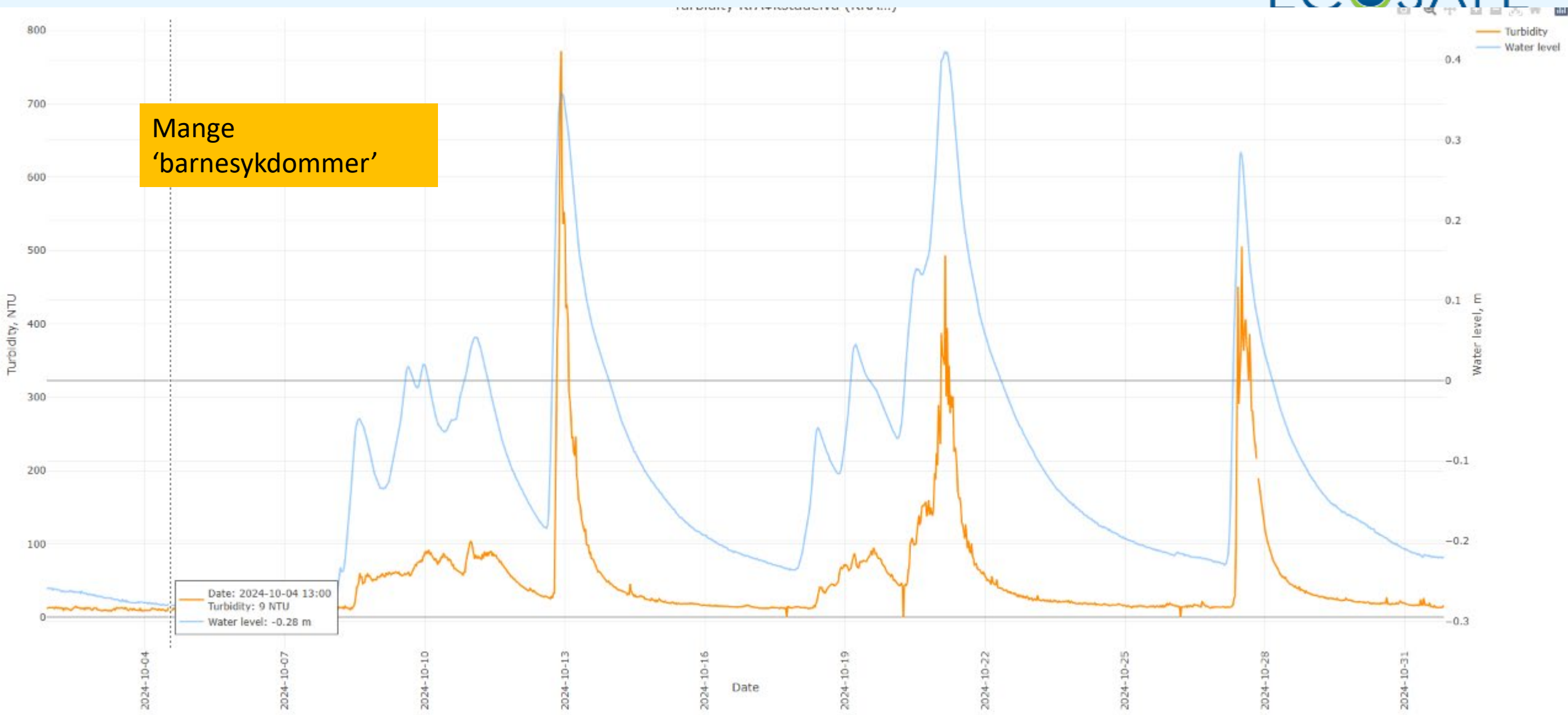

Turbiditet – hvorfor måler vi det?

Kan måle kontinuerlig, godt innarbeidet og relativt rimelig
Korrelerer ofte med partikkelmengde og total fosfor (Tot-P) konsentrasjon

Skuterud (stasjon i utløp i Østensjøvannet)

Suspendert stoff vs turbiditet

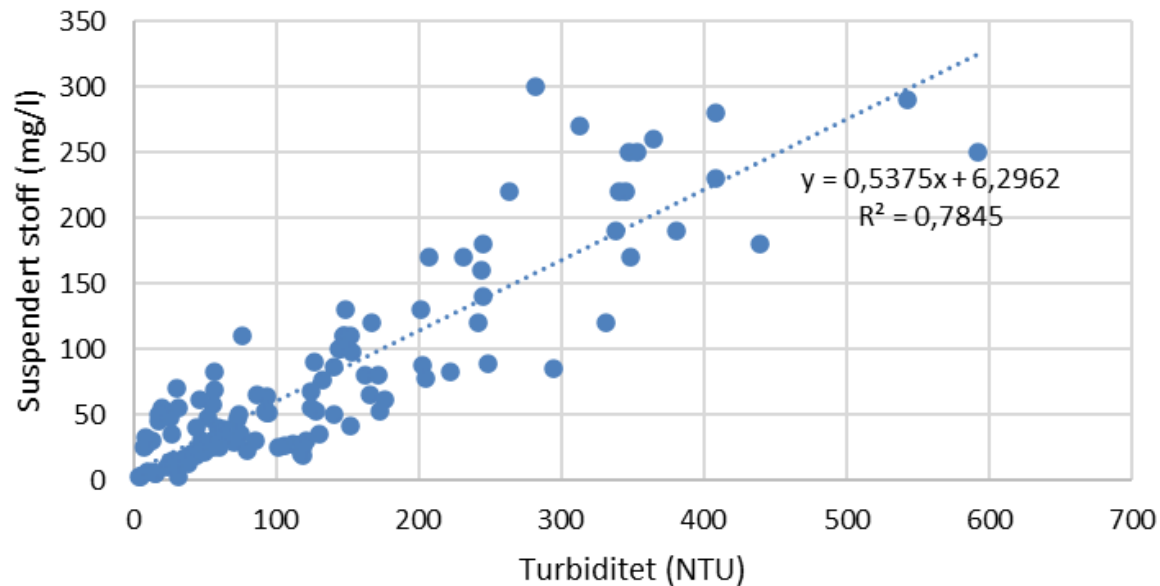

Turbiditet og totalfosfor

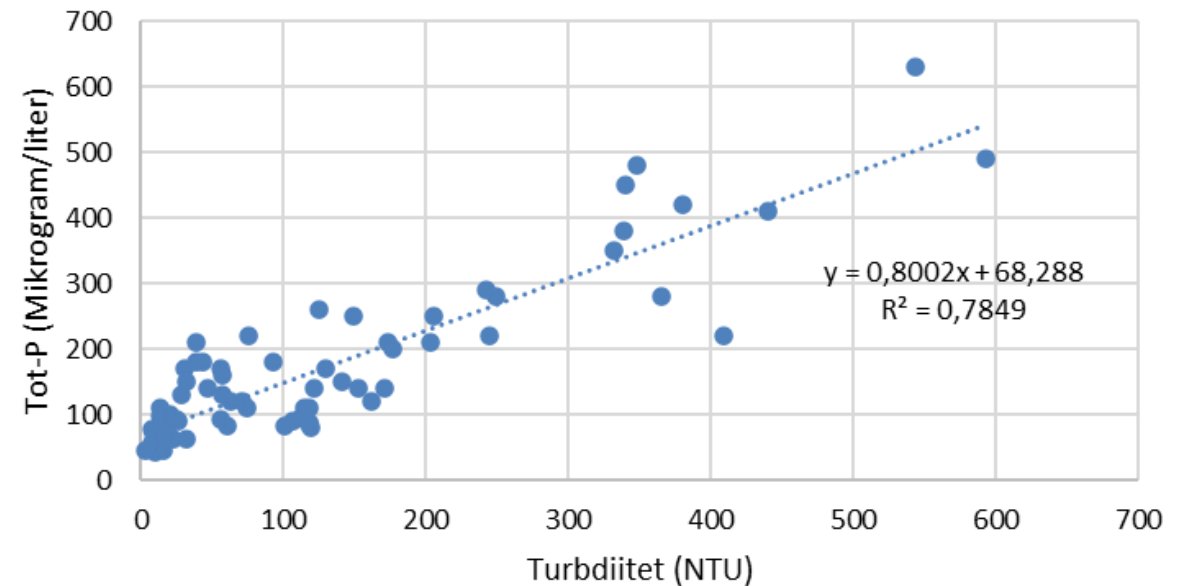

Turbiditet inn og ut av fangdammen Skuterud

Omregnet til suspendert stoff inn og ut

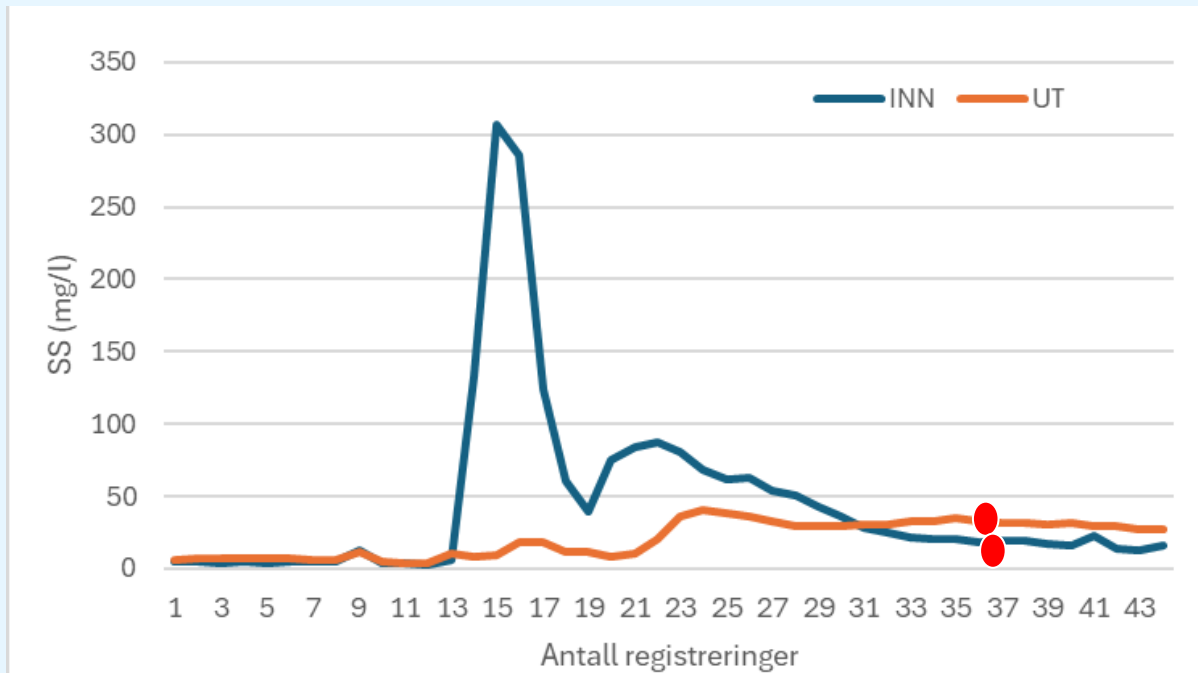

Registreringer per halvtime

Omregnet til Tot-P inn og ut

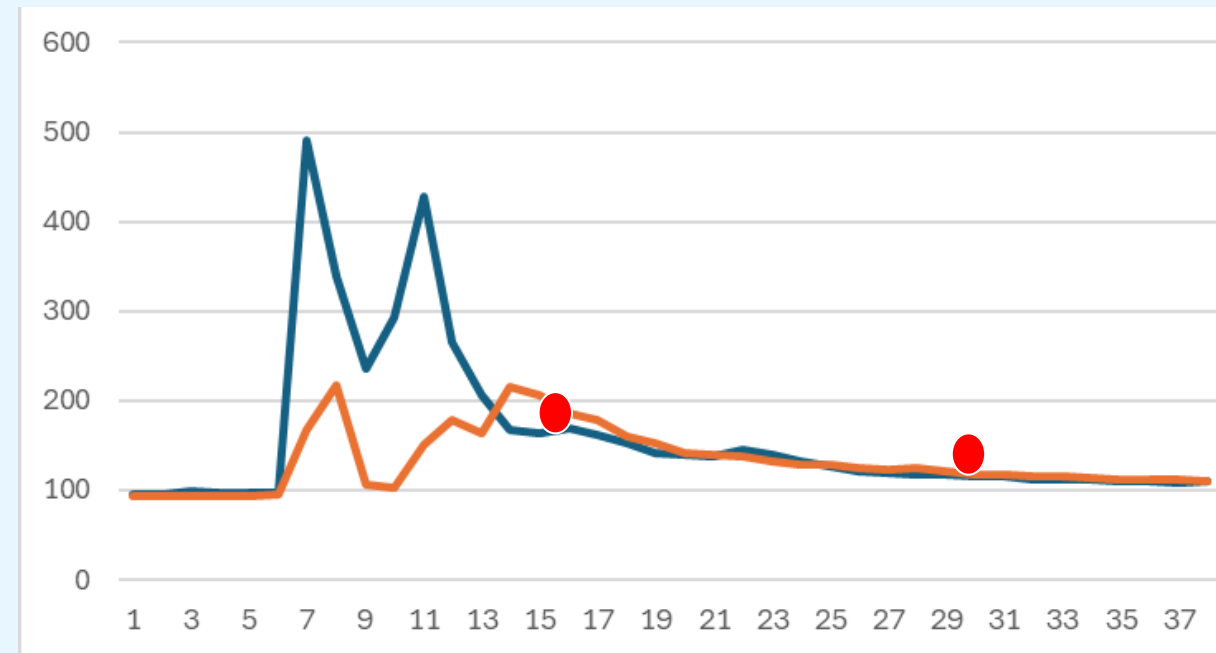

Registreringer per halvtime

Sensordata registrerer de høye konsentrasjonene som stikkprøvene overser

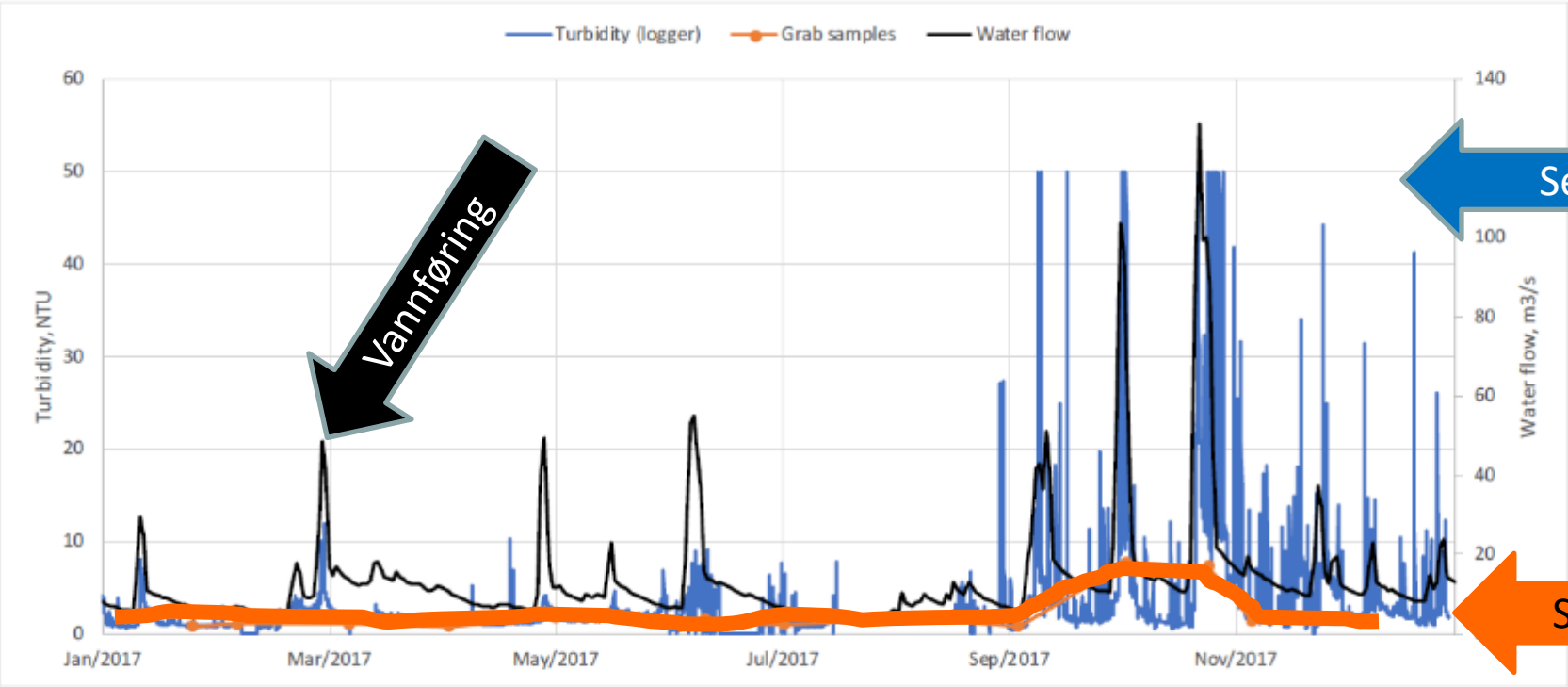

Figure 52. Turbidity and water flow at the outlet of Storelva in 2017. The water flow data are from NVE.

Kaste et al. 2018

Vi har sammenlignet gjennomsnittskonsentrasjoner fra timesdata fra sensor, med 'hjemmelagde' stikkprøver:

- › Vi lagde stikkprøver basert på sensordata: Månedlig, hver 14 dag og ukentlig.
- › Hvordan gjorde vi det??

● F.eks månedlige prøver, den første serien.

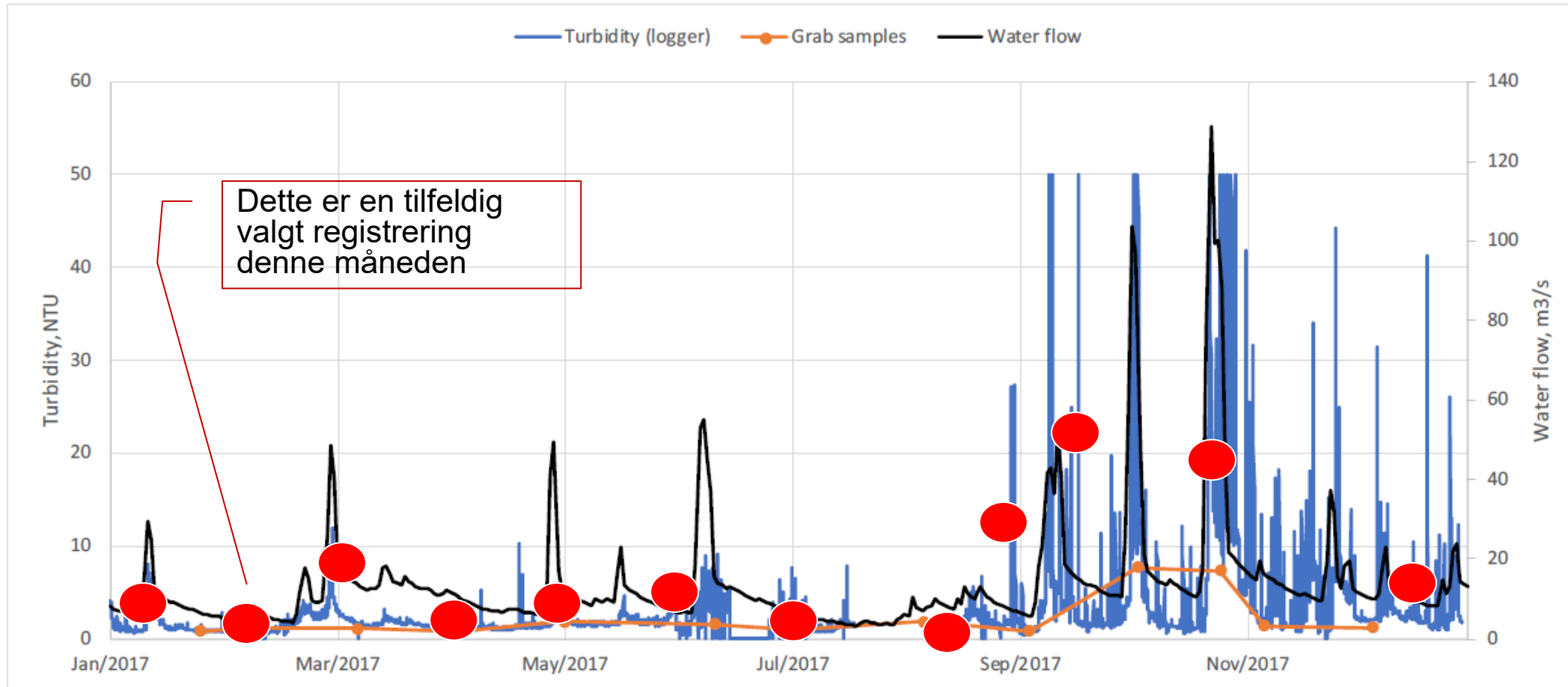

Figure 52. Turbidity and water flow at the outlet of Storelva in 2017. The water flow data are from NVE.

- Månedlige serier, den andre serien. Plukker et vilkårlig datapunkt innenfor hver måned. Dette gjøres 1000 ganger.

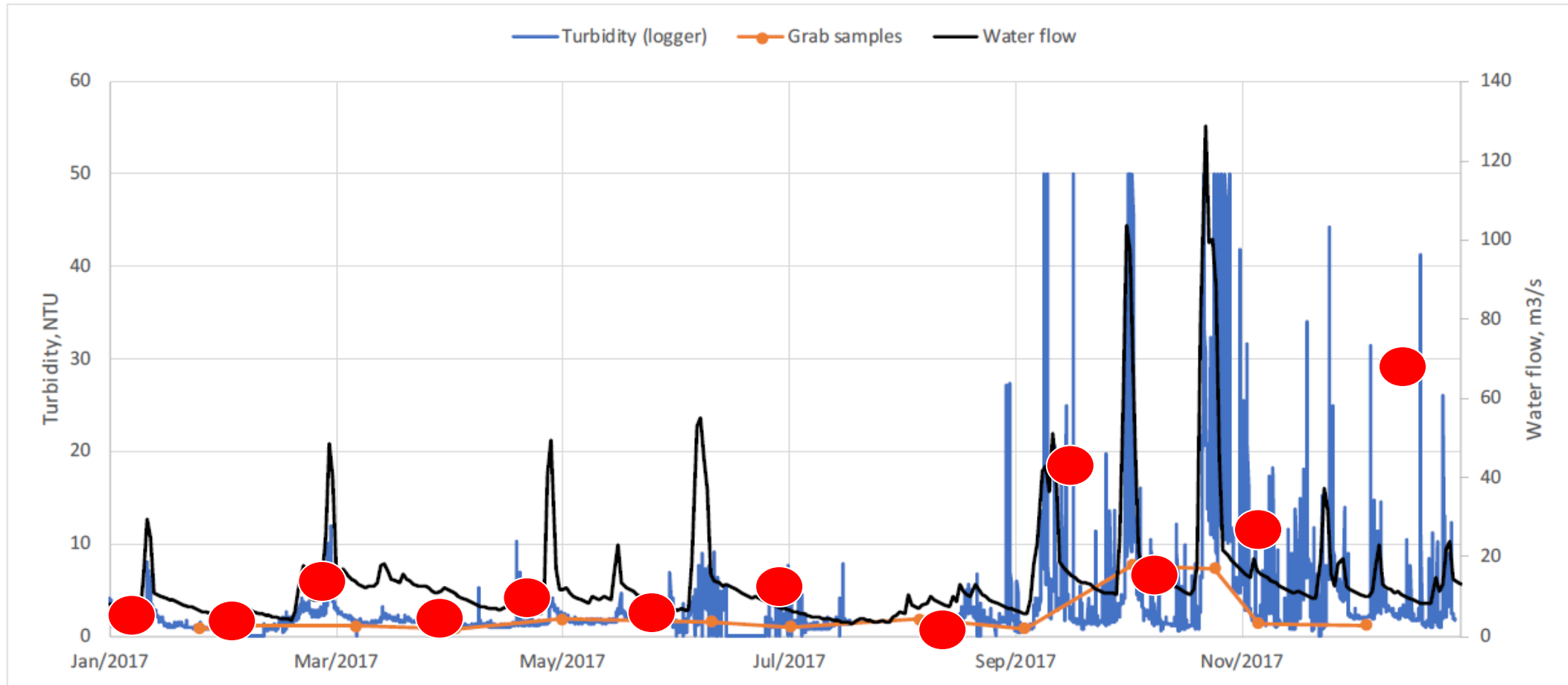

Figure 52. Turbidity and water flow at the outlet of Storelva in 2017. The water flow data are from NVE.

- Tilsvarende for stikkprøver hver 14 dag... 24 prøver hvert år, hvert prøveuttak tas innenfor en 2-ukers periode.

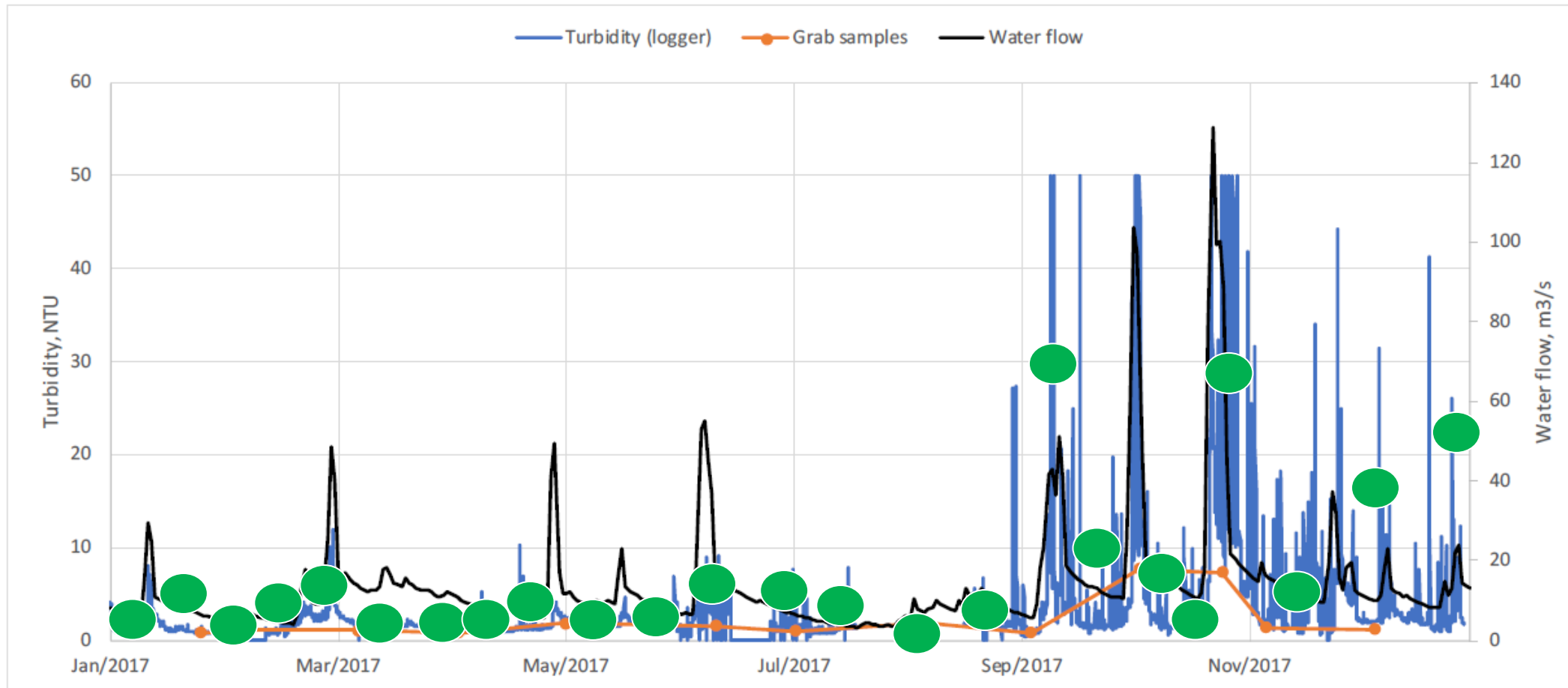

Figure 52. Turbidity and water flow at the outlet of Storelva in 2017. The water flow data are from NVE.

● Her er neste uttak, osv – og tilsvarende for ukentlige serier.

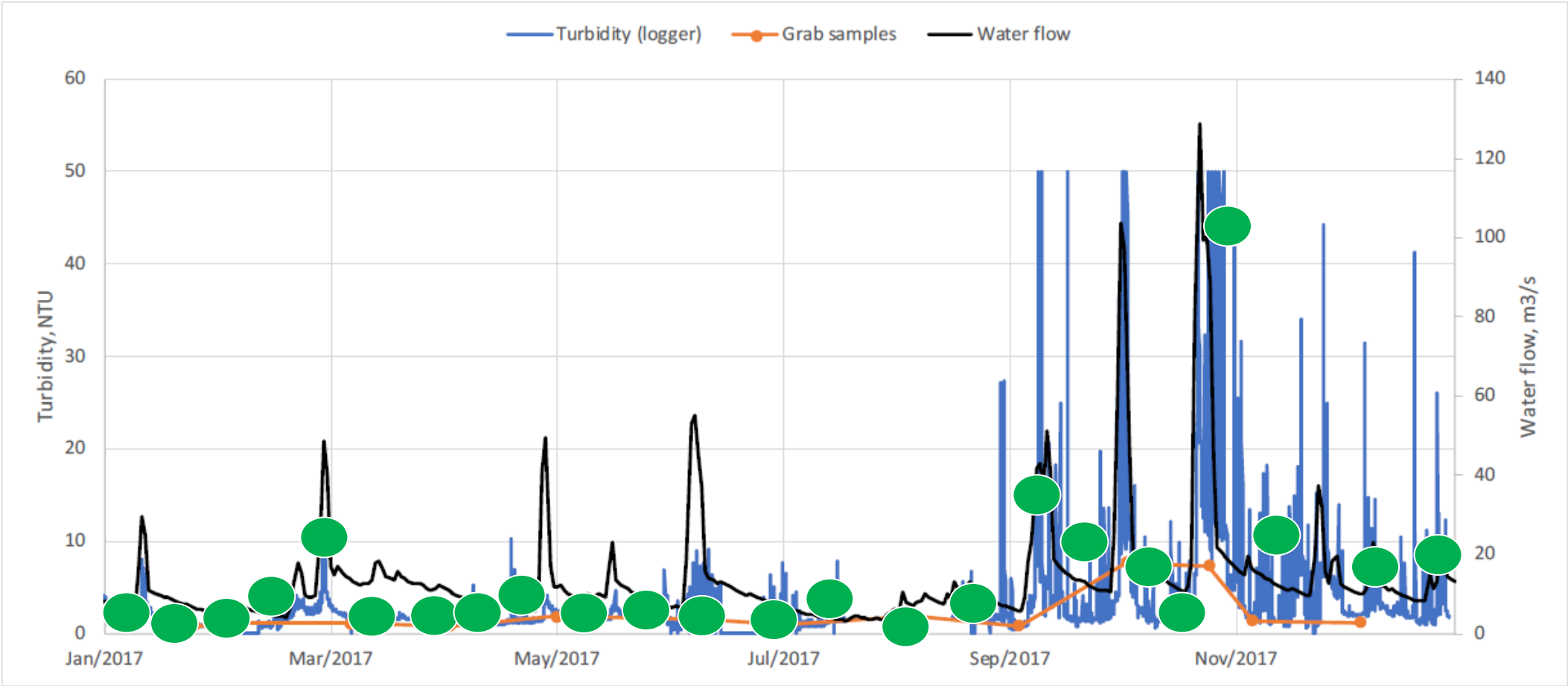

Figure 52. Turbidity and water flow at the outlet of Storelva in 2017. The water flow data are from NVE.

Så sa noen kolleger:

- “Men vi tar jo som regel ikke prøver på søndager. Ikke engang på fredager, for de bør være på labben senest fredag morgen!”
- Så da laget “vi” (=Anastasija) et sett til:
 - Mandag-tirsdag ca kl 9-15 hver dag.
 - Månedlig, hver 14 dag og ukentlig
 - Og gjentok samme prosedyre 1000 ganger.

Dette gjorde vi for et tørt og et vått år – og hvis vi fant et 'normalår, også for dette.

Og hva ble resultatet?

Tørt år: Snittet for halvtimes prøver er ca 27 NTU.
Gjennomsnittlig turbiditet for ukentlige prøver er mellom 15 og 60 NTU.

Vått år: Snittet for halvtimes prøver er ca 60 NTU.
Gjennomsnittlig turbiditet for ukentlige prøver er mellom 36 og 132 NTU.

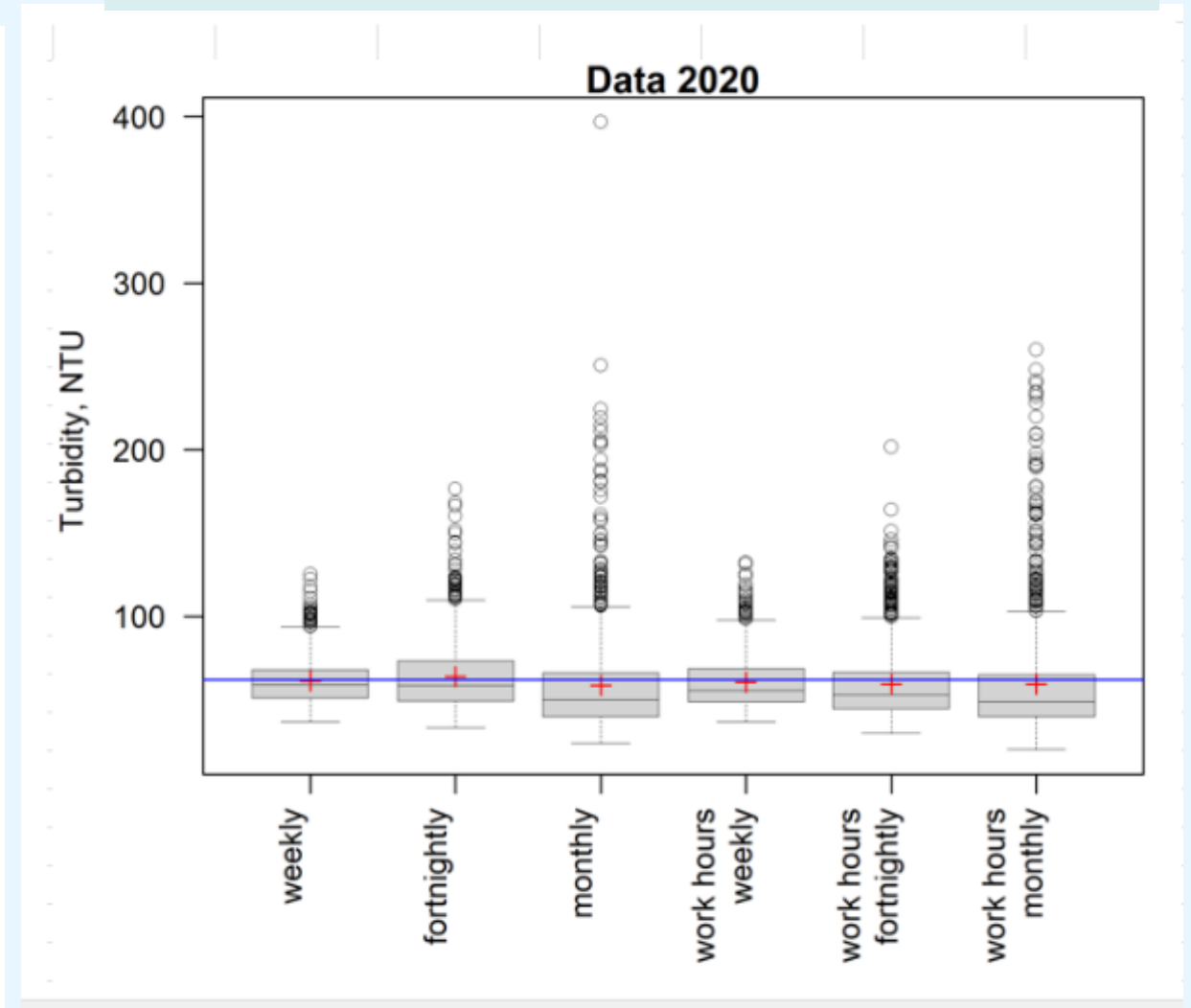
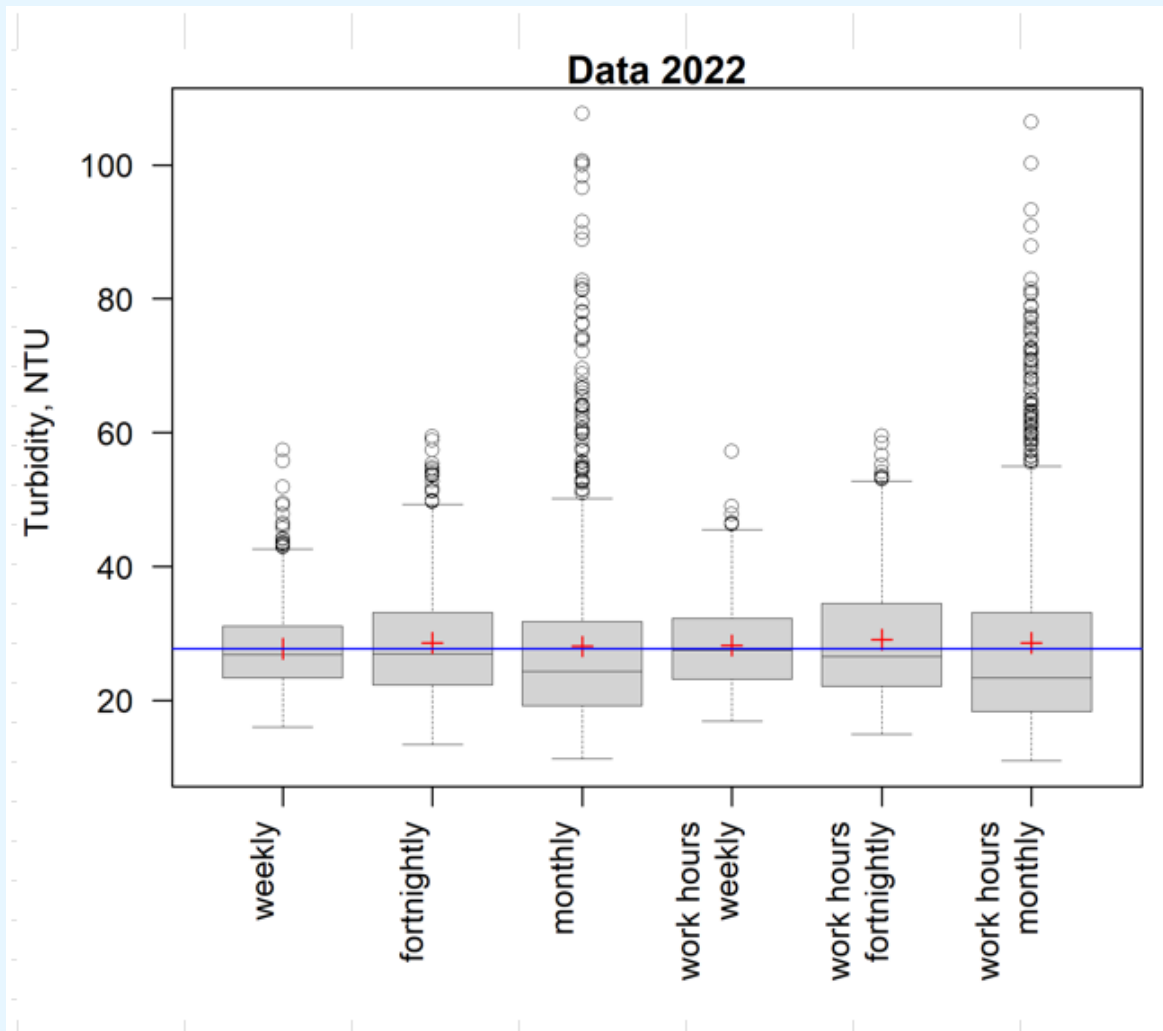

Tørt år: 'sant' gj.snitt: ca. 110 µg/l.

Gjennomsnittlig Tot-P for ukentlige prøver er mellom ca 100 og 136 µg/l. Månedlige: ca. 100-180 µg/l.

Vått år: 'sant' gj.snitt: ca 140 µg/l.

Gjennomsnittlig Tot-P for ukentlige prøver er mellom 120 og 200 µg/l. Månedlige: ca 110- 425 µg/l.

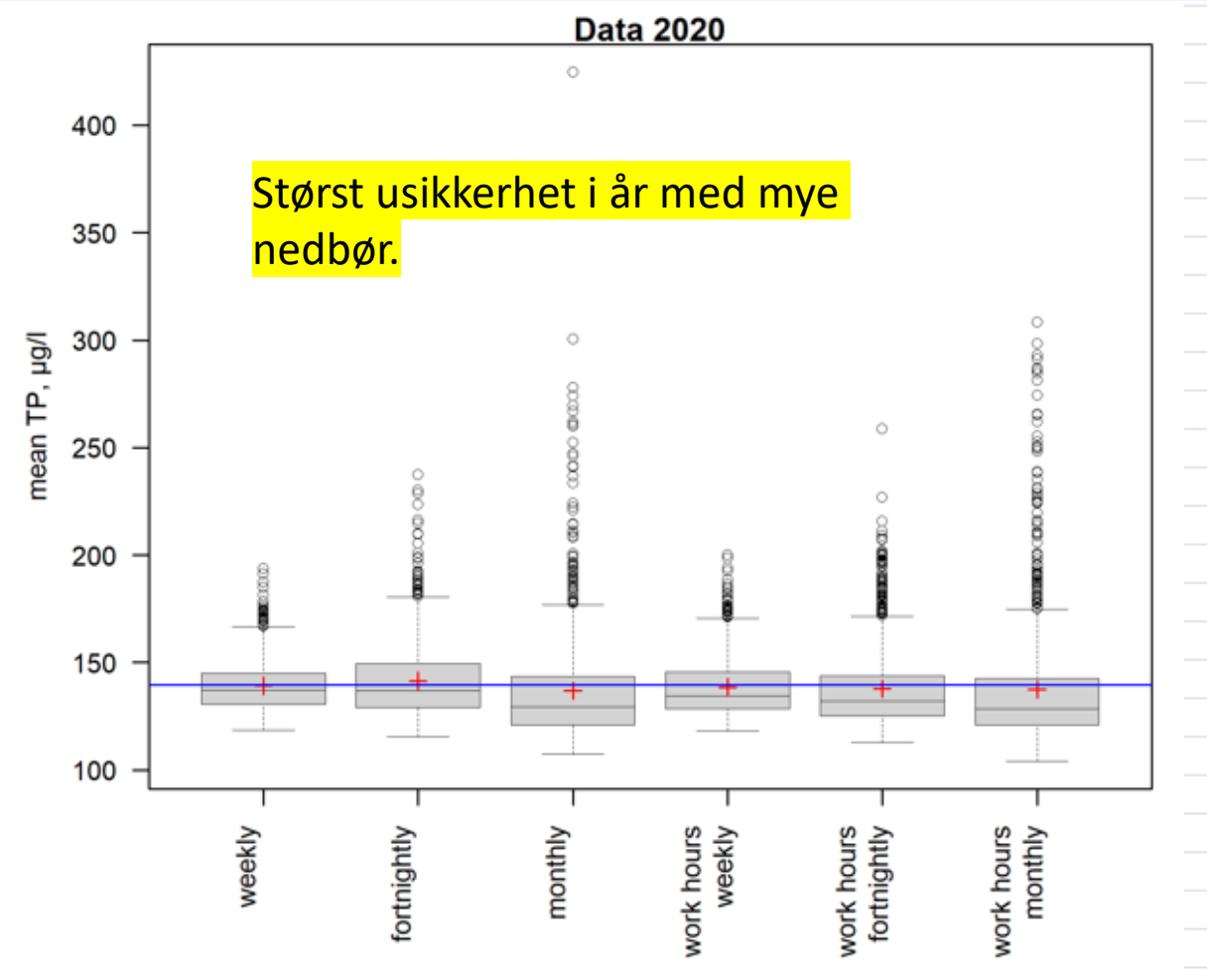
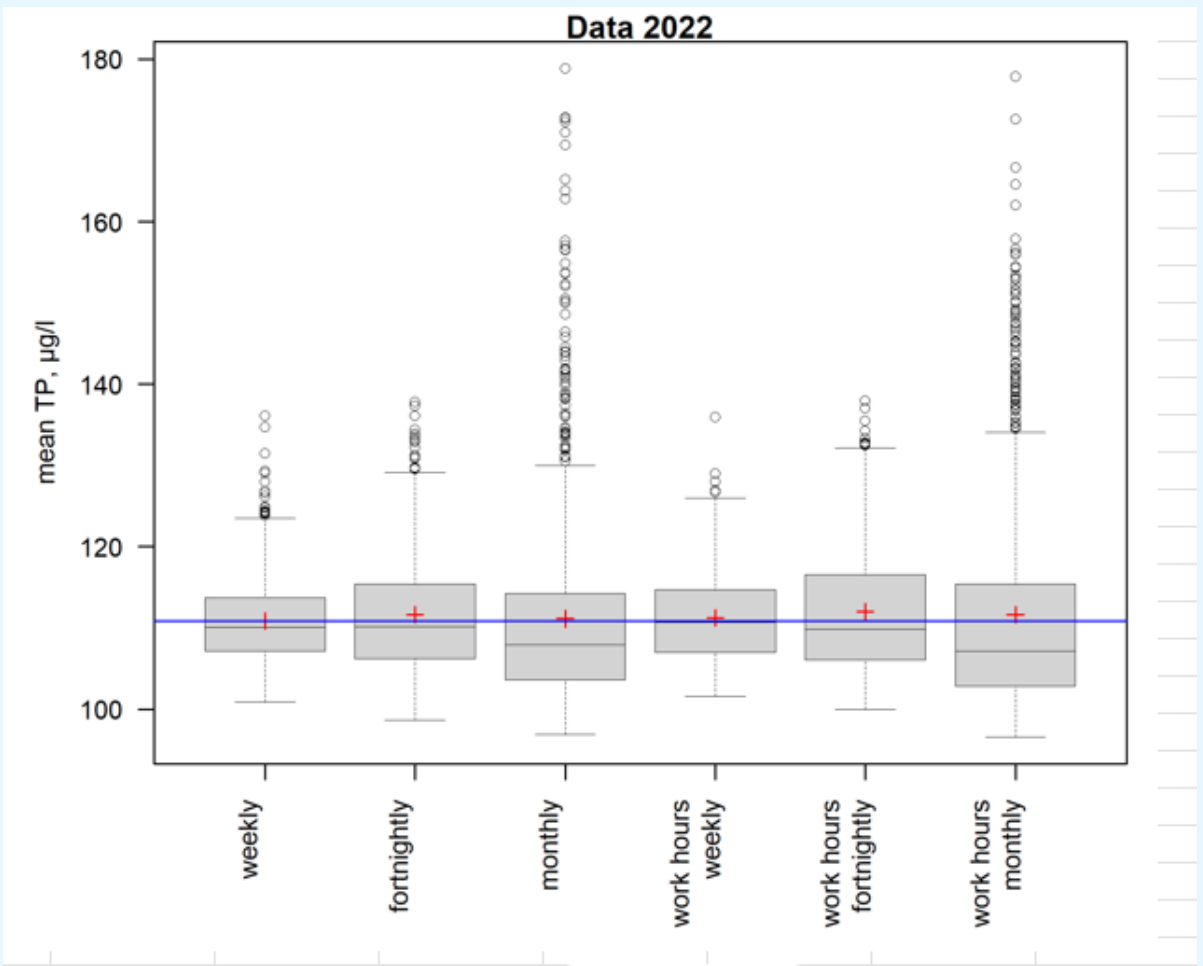

Generelt:

For de fleste strategier, mest sannsynlig at du havner under gjennomsnittet.

Men – det er også slik at hvis du ‘bommer’ – så kan du risikere å få et snitt som er MYE for høyt!

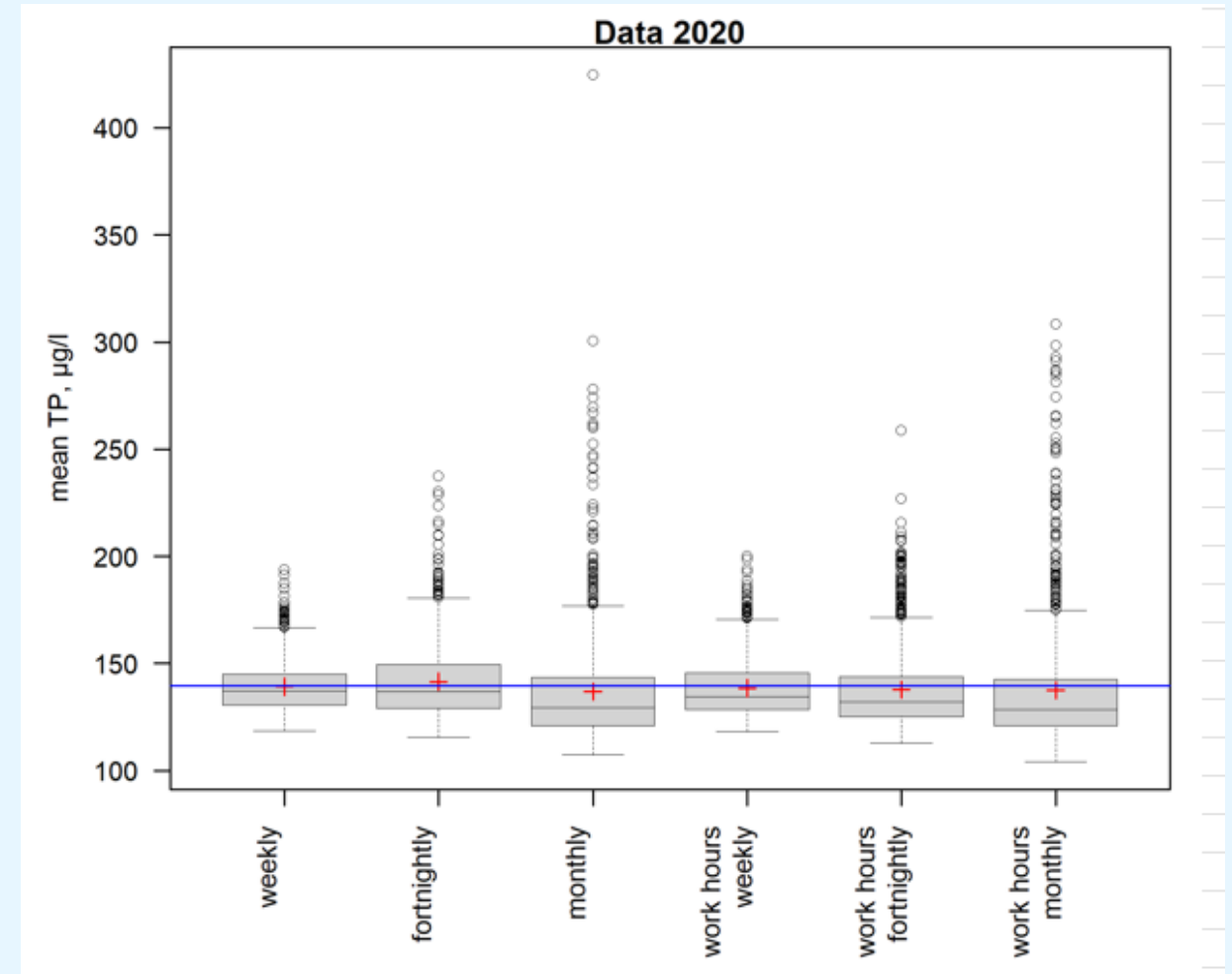
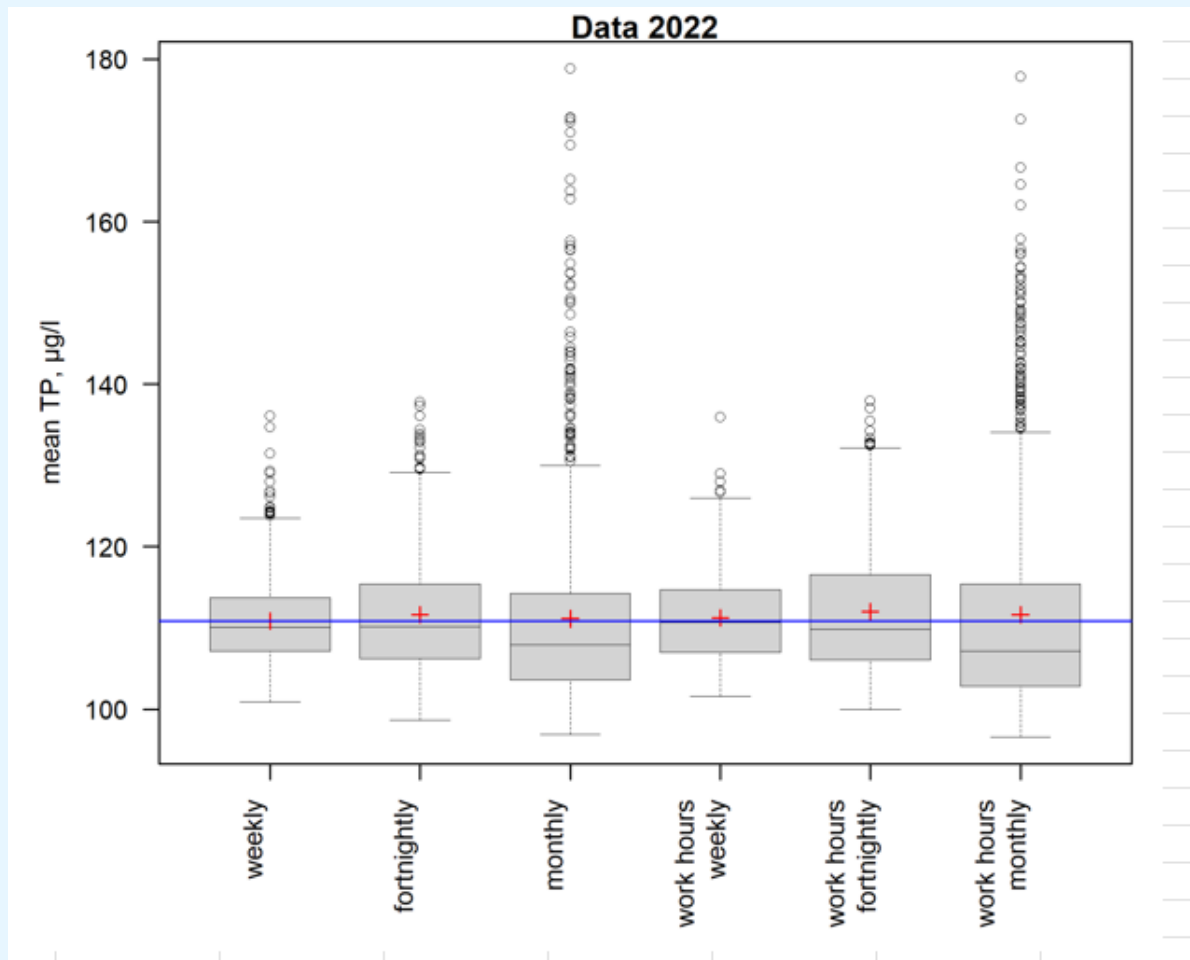

Usikkerhet i å 'treffe' sann middelvei ved månedlig, 14-dag og ukentlig prøvetaking (basert på data fra 4 år, to tørre og to våte)

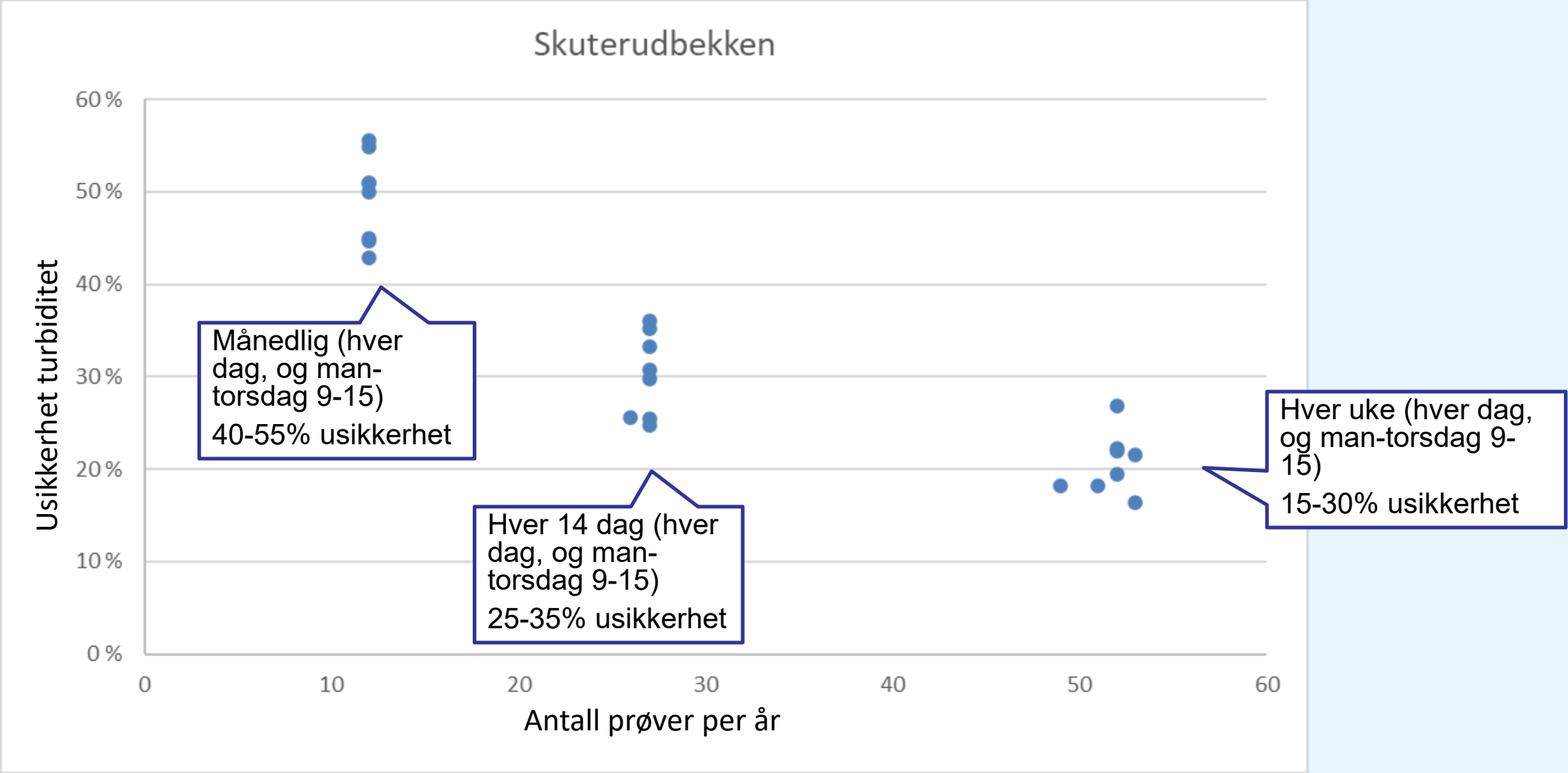

Det samme for Mørdrebekken

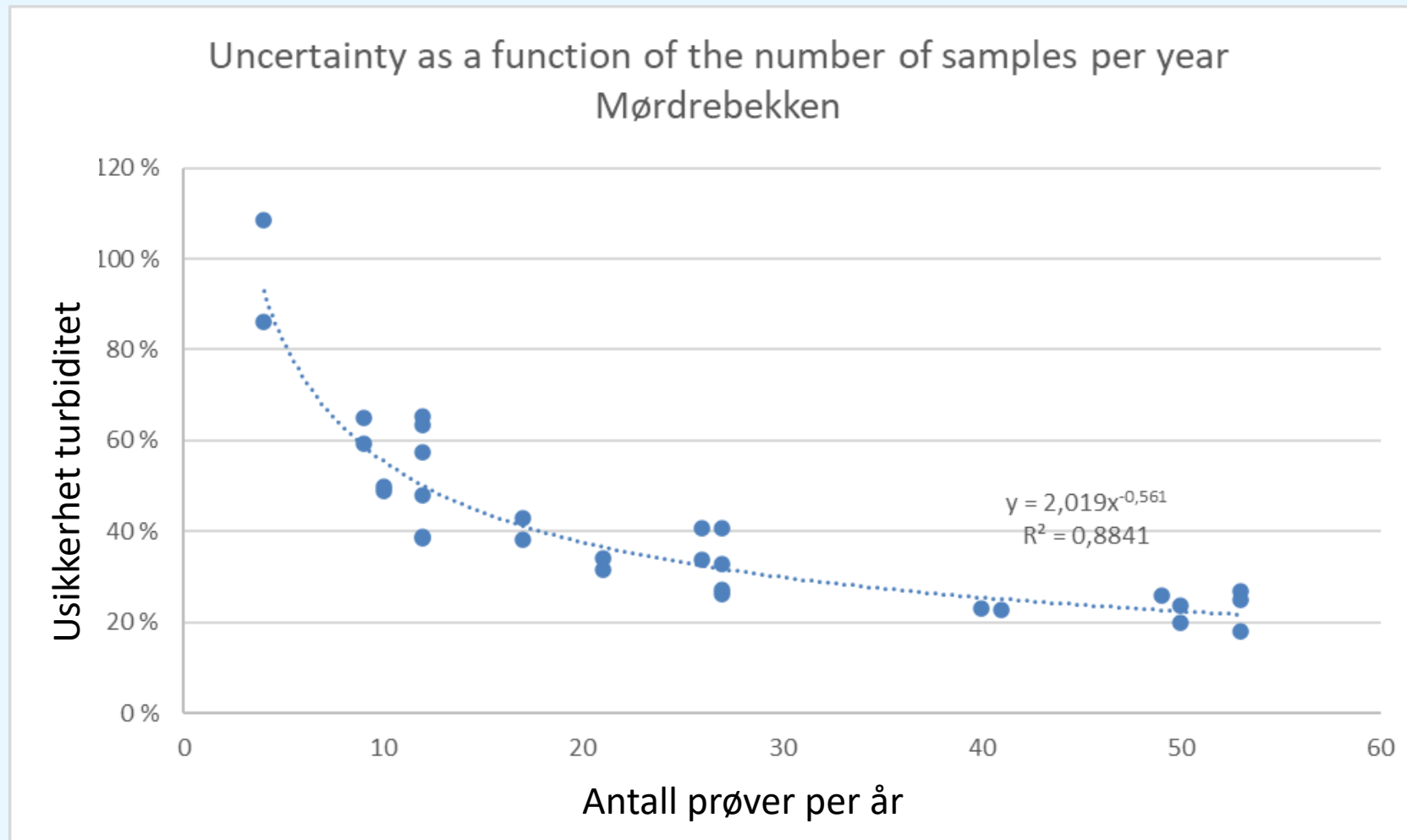

Her laget vi flere frekvenser og fikk en grei kurve som viser hvordan usikkerheten minker med økende prøvetaking, ned mot 20% ved ukentlig prøvetaking.

Burde vi sjekket 2 prøver per uke?

Interessant også å se på litt større elver fra Finland: Mindre usikkerhet!

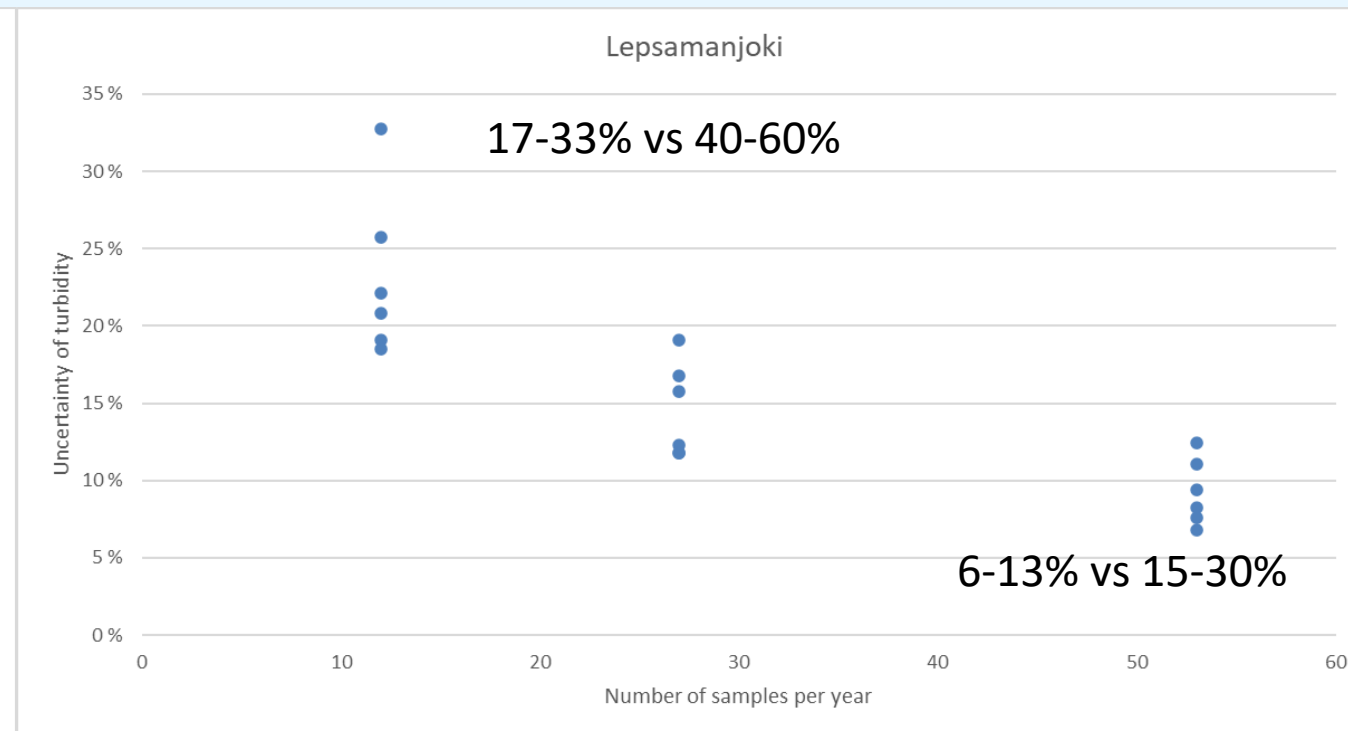
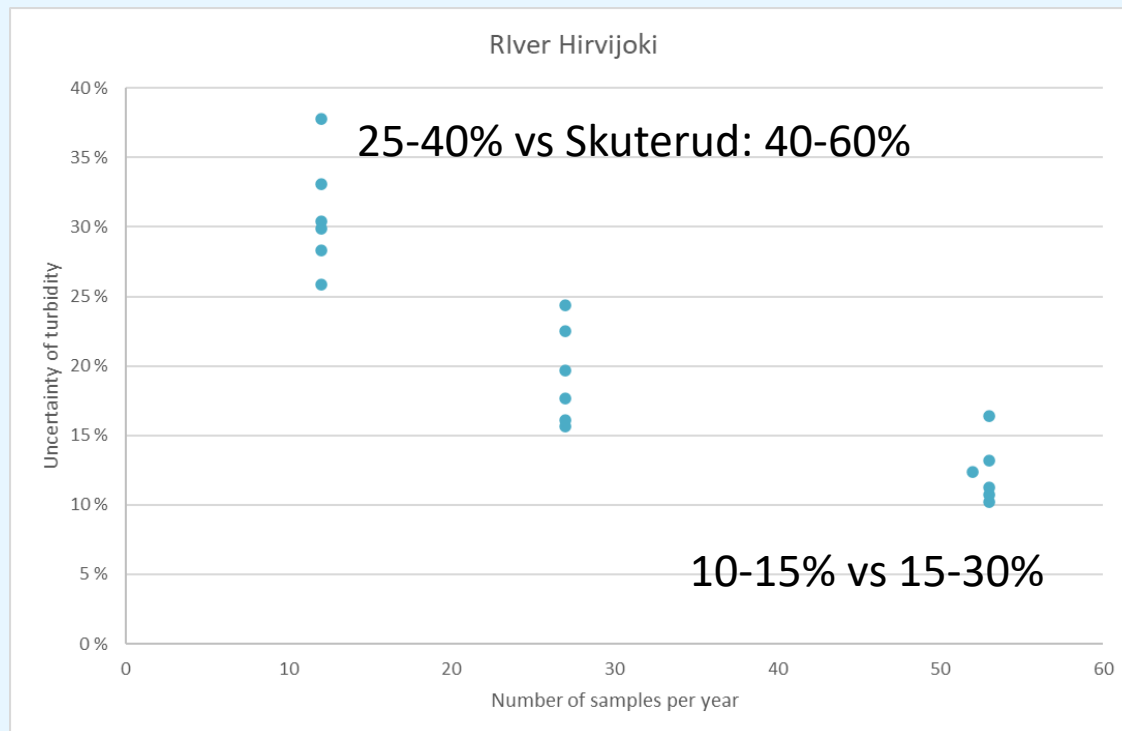

Vi må analysere bedre hvorfor (sannsynligvis mindre variasjon). Men vi bør også få analysert data fra Kråkstad som er et større leirvassdrag enn Skuterudbekken.

Nitrat data fra Danmark

Stikkprøver av nitrat tatt ut hver uke, 14. dag og måned.

Til tross for at nitrat er et mer 'konservativt' stoff som ikke varierer så mye som partikler og partikulært fosfor, er det også stor usikkerhet her. +/- 5-10 % for ukentlig og +/- 10-30 % for månedlig.

La oss få ut noen nitratsensorer i norske jordbrukselver!

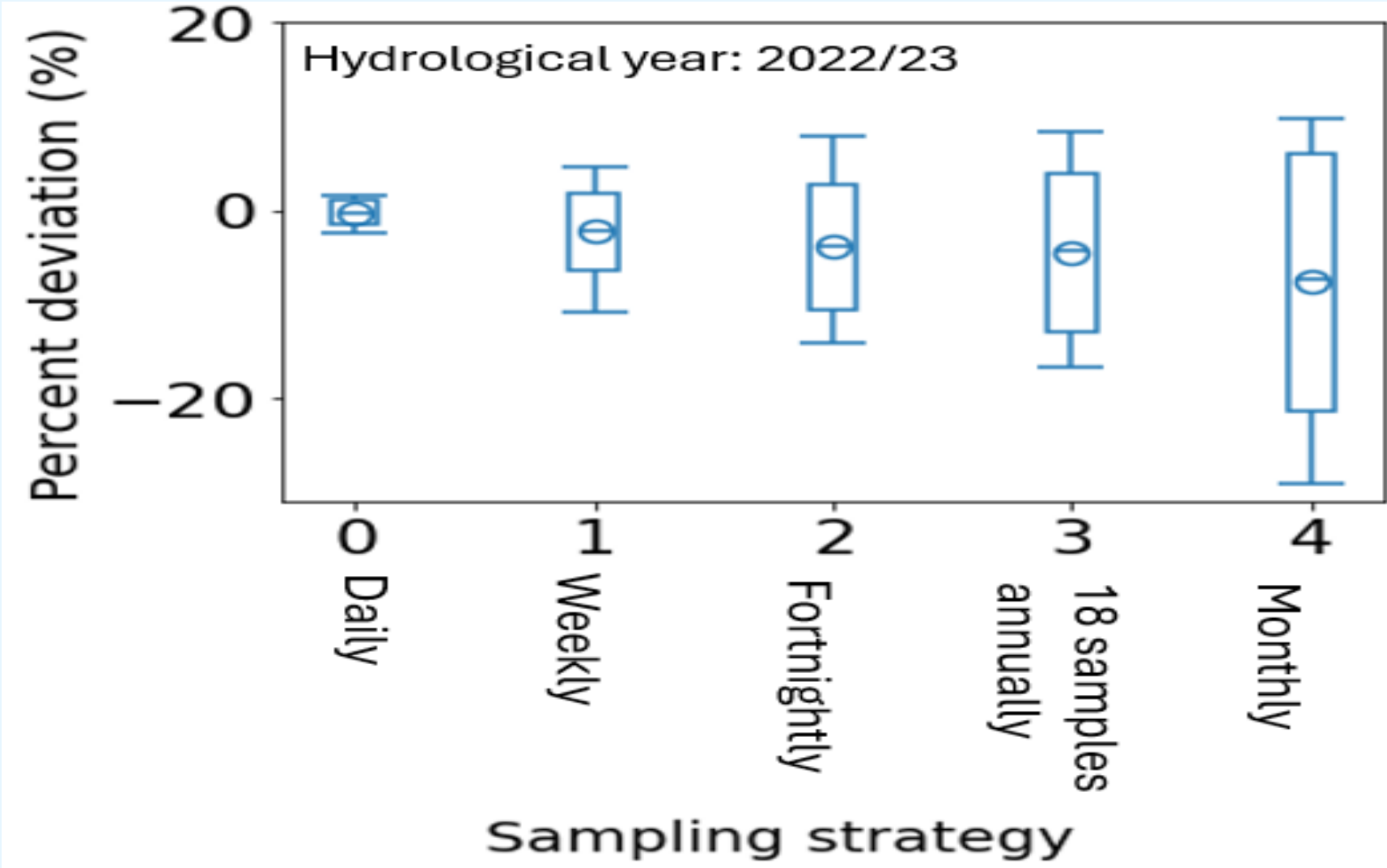

Hva kan vi godta? Eksempel Tot-P:

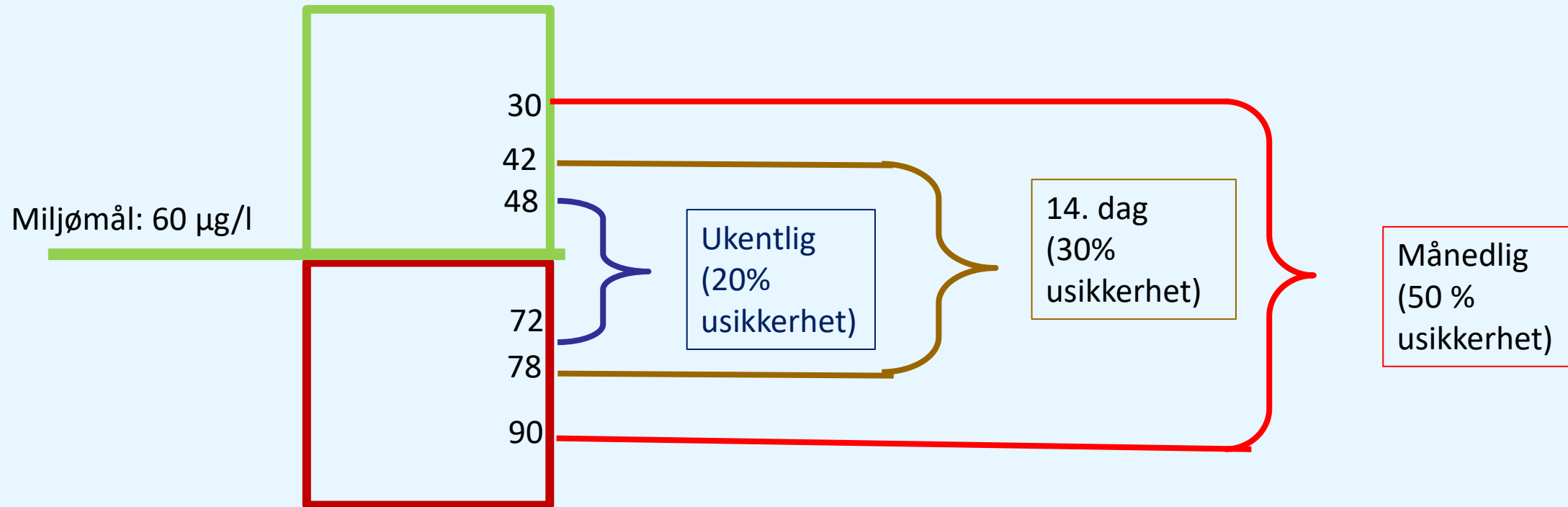

Hva kan vi godta? Kanskje vi kan godta større usikkerhet om vi er langt unna miljømålet?

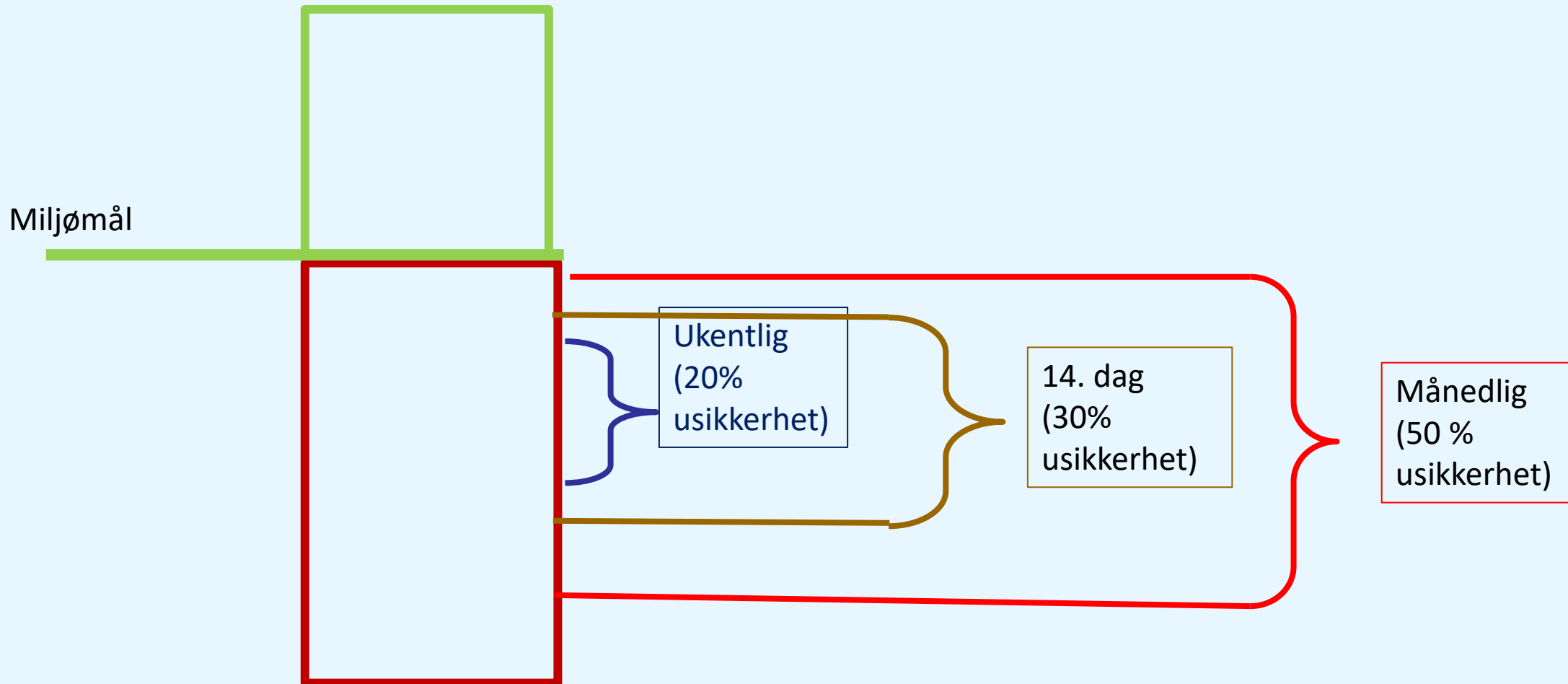

Eller er over målet, unntatt kanskje for månedlige prøver? :

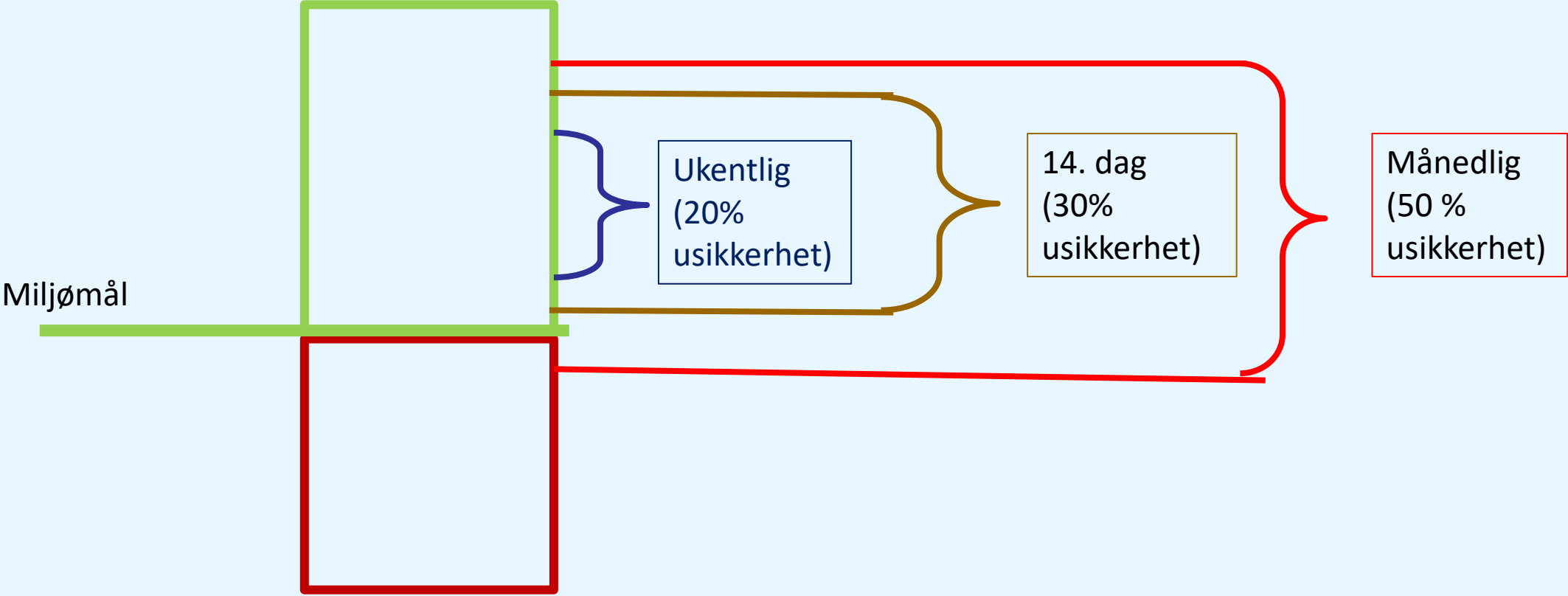

WP2: Sanntidsdata fra sensorer på nett

Real-time data from seven Nordic streams, shown on the project website: <https://projects.au.dk/nordbalt-ecosafe>



Hvorfor har vi informert, og hvordan:

- › **Hvordan:** Ved hjelp av dere! 😊
- › **Hvorfor:** motivere og informere – for å se om dette kan gi bønder, annen lokalbefolkning og lokal forvaltning økt interesse og motivasjon for å følge med på tilstanden i bekken
- › (etter inspirasjon fra bl.a. New Zealand hvor de har hatt gode erfaringer med dette)

Sanntidsdata fra sensorer i bekker



Nordbalt/Åkershus län, foto: Eva Skerfving

PUBLISERT: 24.05.2021

KONTAKT PERSON

Eva Skerfving
Sensordata - Utveier for miljø og naturforvaltning
1 471 418 33 000
www.nordbalt.se/evaskerfving
Kontakt: Eva Skerfving

Lenker

[Sanntidsdata fra sensorer i bekker](#)

Takstørk om sensorer i bekker
Informasjon om sensorer i bekker og bekker
1.000 KB PDF

SKUTERLÖBOKEN
Höjnings: 4,5 km/h
Användnings: Jordbruk 20%, Skog 20%, Bekker 20%,
vårskog 20%
Vannressur: PUMA

Hvordan står det til i bekken?

De som bor i nærheten av en bekk har nok lagt merke til at bekken ikke alltid ser likt ut, som den gamle filosofen Heraklitos sa for 2500 år siden: Du kan ikke gå ned i den samme elven to ganger! Med det mente han at elven hele tiden forandrer seg.

I Norge er elvene gjerne i lagde om vinteren, så kommer siden med snøsmelting og høy vannføring, deretter kommer kanskje en tørr sommer med lav vannføring, før høstet kommer på og gi økt vannføring. I bekkene slager slike endringer både elvene og fiskene om i elven. Nærbefolket til en bekk er like, og en kortlig regnerperiode kan forvandle en stilleflytende bekk til friløpende vannmasser på bare noen timer.

Derfor overvåker NIBIO enkelte bekker så ofte som høytid. Dette gjøres med sensorer, og på denne siden kan du følge med på vannkvaliteten i to jordbruksbekker i Åkershus fylke: Kållstadselven og Skutervikbekken. Data oppdateres hver dag klokken 0:00.

Vi legger ut disse data for at forvaltere, bønder og andre i naboblaget kan følge med på hva som skjer i "naboblag"-bekken!

Til venstre på denne siden finner du et feltark om sensorer.

Hva måler sensorene våre?

Det som ruller i sensorene våre i disse to bekkene er turbiditet og vannhøyde. Turbiditet er et mål på mengden jordpartikler i bekken. Høy turbiditet betyr at det har endret mye jordpartikler, enten fra jordens masser eller fra bekkeløst, som regel fra bygge støier. Høy turbiditet betyr også høy konsentrasjon av fosfor i disse bekkene, siden de mottar gjødsel fra mark og med naturlig høyt innhold av fosfor, og siden de drenerer jordbruksområder. Vannhøyden er - som navnet tilsier - hvor høy vannstanden i bekken er. Høy vannstand betyr høy vannføring, mens lav vannstand betyr lav vannføring.

Sanntidsdata er ikke kvalitetssikret

Det er viktig å være klar over at dette er rådata som ikke er kvalitetssikret. Nærliggende på denne siden er det viktig å være klar over at dette er rådata som ikke er kvalitetssikret. Nærliggende på denne siden er det viktig å være klar over at dette er rådata som ikke er kvalitetssikret.

HVA FORTELLER MODELLER OM EFFEKTER AV TILTAK OG KLIMAENDRINGER?

Csilla Farkas, Moritz Shore, Mojtaba Shaifei, Anne-Grete Buseth-Blankenberg, Eva Skarbøvik
& den NIBIO Nordbalt-Ecosafe gruppe



NordBalt Ecosafe workshop

Ski, 7. november 2024

Hobølva; Copyright: Copyright Kjetil Palmquist

Målkonflikten

matproduksjon
matsikkerhet



miljø og
naturlig mangfold

klimaendringen

sosioøkonomiske faktorer

**Hva slags tiltak som kan sikre mat- og miljøriskerhet
under nåværende og fremtidige forhold?**

Påvirkning av landbrukspraksis på vannkvaliteten

Vi vet mye OM ...

- påvirkning av jordbearbeiding
- påvirkning av avlingsforvaltning
- tiltakseffekter
- påvirkningen av pågående klimaendringer

FRA ...

- felteksperimenter
- lokale ekspertise / erfaring
- datautvinning og analyser
- evaluering i nedbørfeltskala

Eksempler på praktisk erfaring

1. Jordbearbeidingsystem

konvensjonell

reduisert

direkte såing



Photo credit: NICRA, FreePic

	konvensjonell	reduisert
jordpakking	↑	↓
vannretensjon	↓	↑
karbondbinding	↓	↑

2. Jordbearbeidingstidspunkt

om høsten uten jordekke

om våren



Photo credit: R. Barneveld, NIBIO



Photo credit: Dreamstime.com

	om høsten	om våren
jordstruktur	↓	↑
vannretensjon	↓	↑
jordtap	↑	↓
P-tap	↑	↓

- ✓ Trygge sageforhold
- ✓ Sikker avling

- ✓ Mindre og mindre sikkert avling
- ✓ Problem med jordtrafikk om våren

Påvirkning av landbrukspraksis på vannkvaliteten

Vi vet mye OM ...

- påvirkning av jordbearbeiding
- påvirkning av avlingsforvaltning
- tiltakseffekter
- påvirkningen av pågående klimaendringer

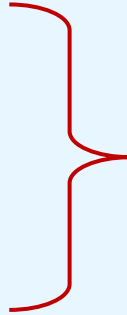

- jord-, avling- og regionspesifikk
- avhenger av lokale forhold
- kan ikke tolkes for **fremtidige klimaforhold**
- kan ikke brukes for **tiltak optimalisering**

FRA ...

- felteksperimenter
- lokale ekspertise / erfaring
- datautvinning og analyser
- evaluering i nedbørfeltskala

Men ikke nok, siden at

- kunnskapen vår er region-, avlings- og jordspesifikk
- **Kunnskapene kan ikke ekstrapoleres til ukjente forhold**

Mål: Å forstå de naturlig observerte fenomenene og kunne forutsi dem

Vi bruker modeller for

- utvikle vitenskapelig forståelse av komplekse systemer
- romlig og tidsmessig utvidelse av data og kunnskap
- testing av systemets reaksjon på endrede/uobserverbare forhold
- optimalisering, planlegging og støtte til beslutningstakere

Fordeler med å bruke SWAT+ i Nordbalt-Ecosafe

- Kan simulere prosessene i fokus
- Fokuserer på jordbruksarealer
- Beskrive jordarbeidingspraksis og vekstskifte for hvert felt
- Beskriver konnektivitet i landskapet
- Kan simulere effekten av ulike tiltak
- Kan simulere effekten av klimaendringen
- Gratis programvare
- Mye brukt og testet
- Utmerket støtteteam og støttegruppe

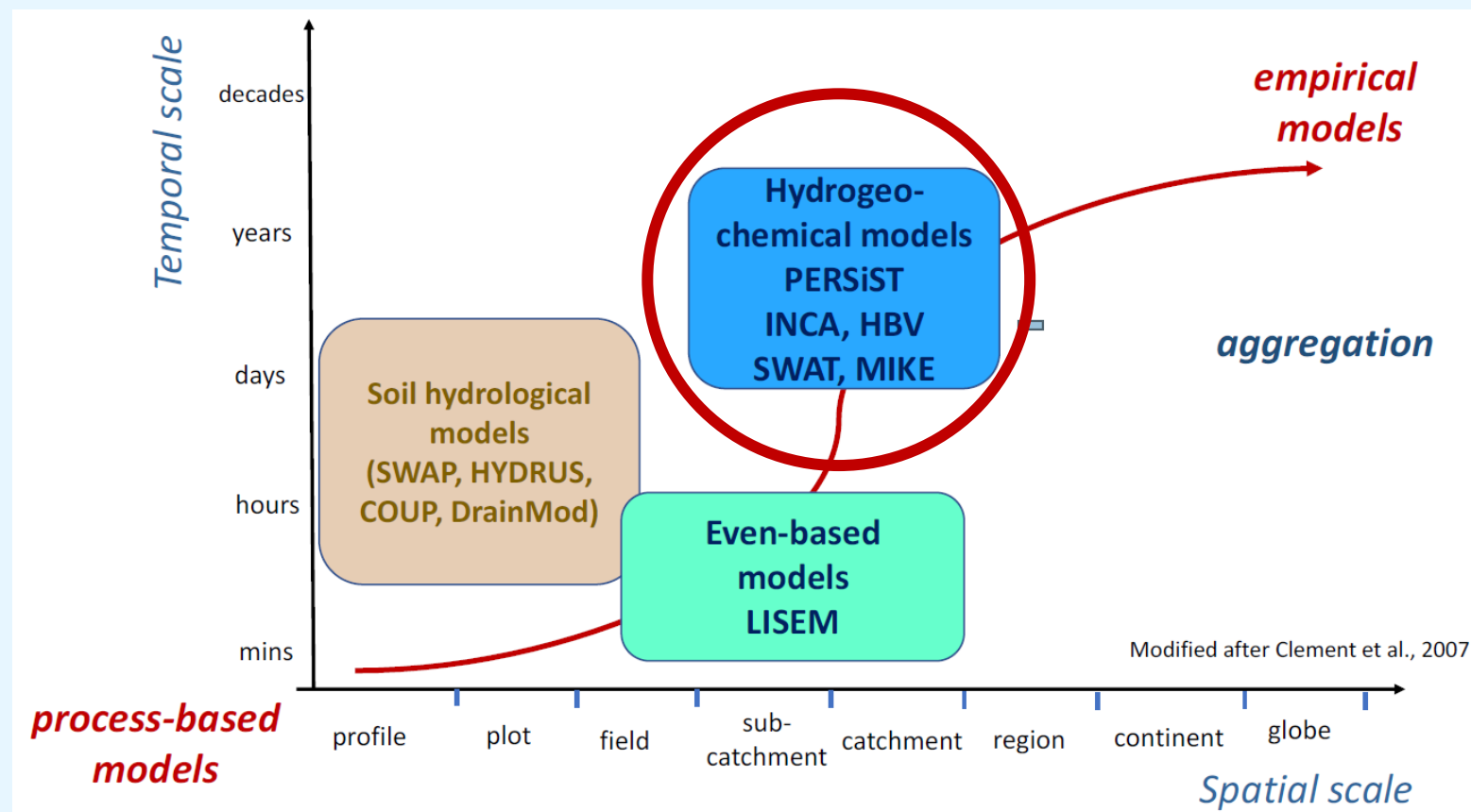

Vi bruker SWAT+ modellen i to EU prosjekter

OPTAIN (2020-2026)

- ✓ Datainnsamling
- ✓ Modelloppsett
- ✓ Kalibrering / validering: hydrologi
- ✓ Kalibrering / validering: vannkvalitet
- ✓ Scenarioanalyse: tiltak
- ✓ Scenarioanalyse: klimaendring
- Kombinerte scenarioanalyser
- Optimalisering

Pilot nedbørfelt: Kråkstad

Tiltak:

- ✓ ingen jordarbeid i høst
- ✓ kantsoner
- ✓ grasdekte vannveier
- ☹️ • fangdammer
- ✓ Sedimentasjonsdammer i skog

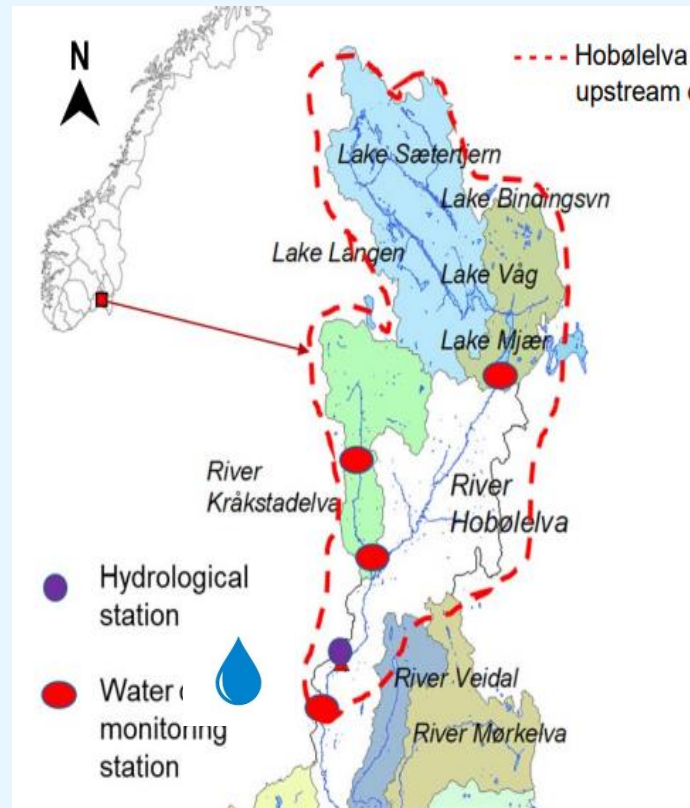

Photo credit : Morten Günther, NIBIO

NORDBALT-ECOSAFE (2022-2025)

- ✓ datainnsamling
- ✓ modelloppsett
- ✓ kalibrering / validering: hydrologi
- Kalibrering / validering: vannkvalitet
- Scenarioanalyse: tiltak
- Scenarioanalyse: klimaendring
- sammenligne resultatene med de nasjonale modellene (Teotil, Agritil)

Pilot nedbørfelt: Hobøelva

Tiltak:

- ingen jordarbeid i høst ?
- Kantsoner ?
- grasdekte vannveier ?
- avhengig av mentimeter resultater

Implementering av tiltak i modellstrukturen

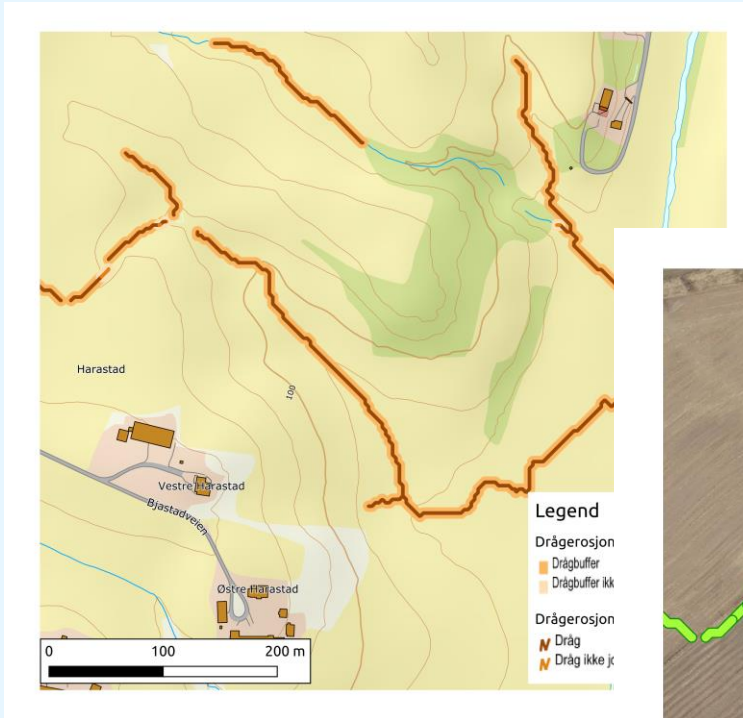

Erosjonrisikokart:
drågerosjon



Photo credit: R. Barneveld, NIBIO

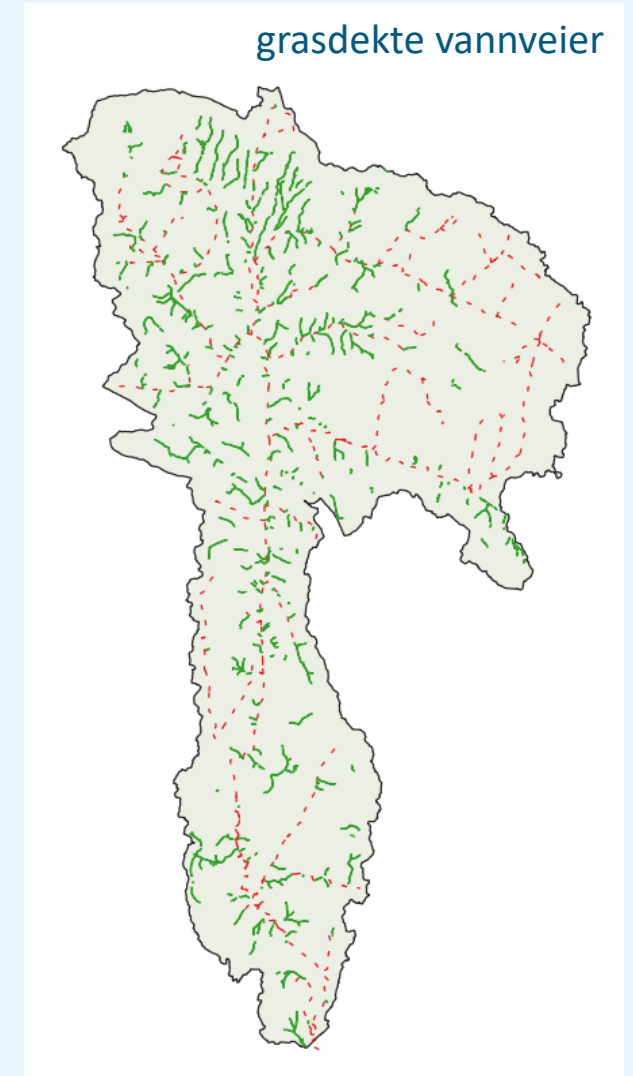

Fra Robert Barneveld, NIBIO

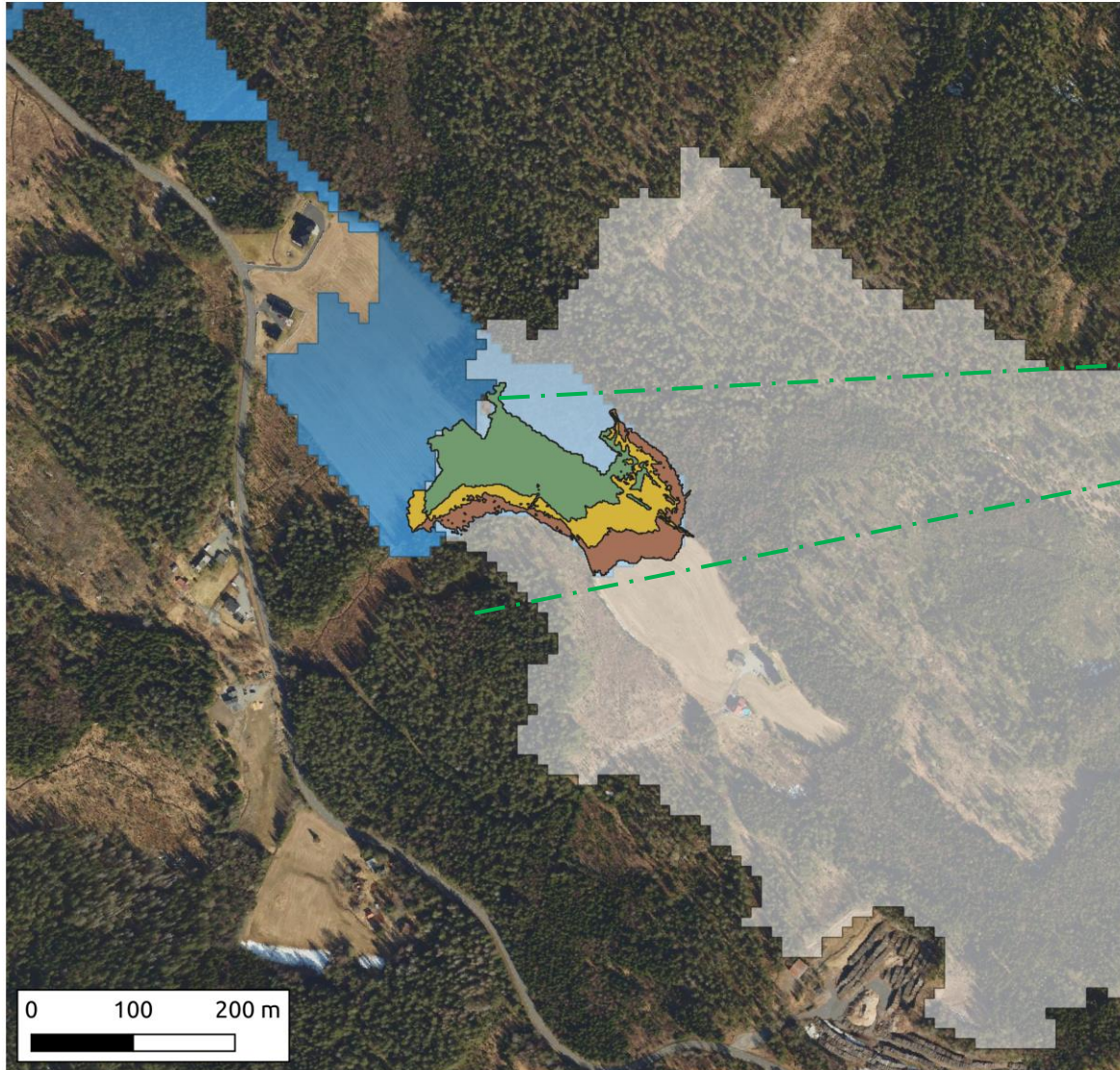
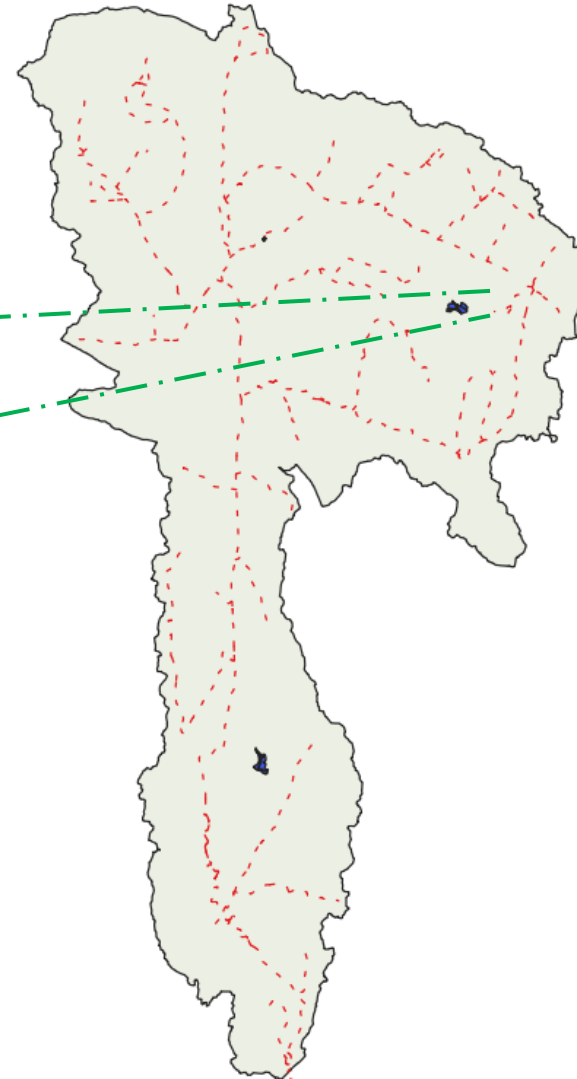

Photo credit: R. Barneveld, NIBIO

retensjon dammer i skog



Fra Robert Barneveld, NIBIO

Resultater fra scenarioanalyser for Kråkstad

Relative endringer i hydrologiske parameterne i forhold til basisperioden (%)

– tiltakseffekter ved maksimalt implementeringsnivå

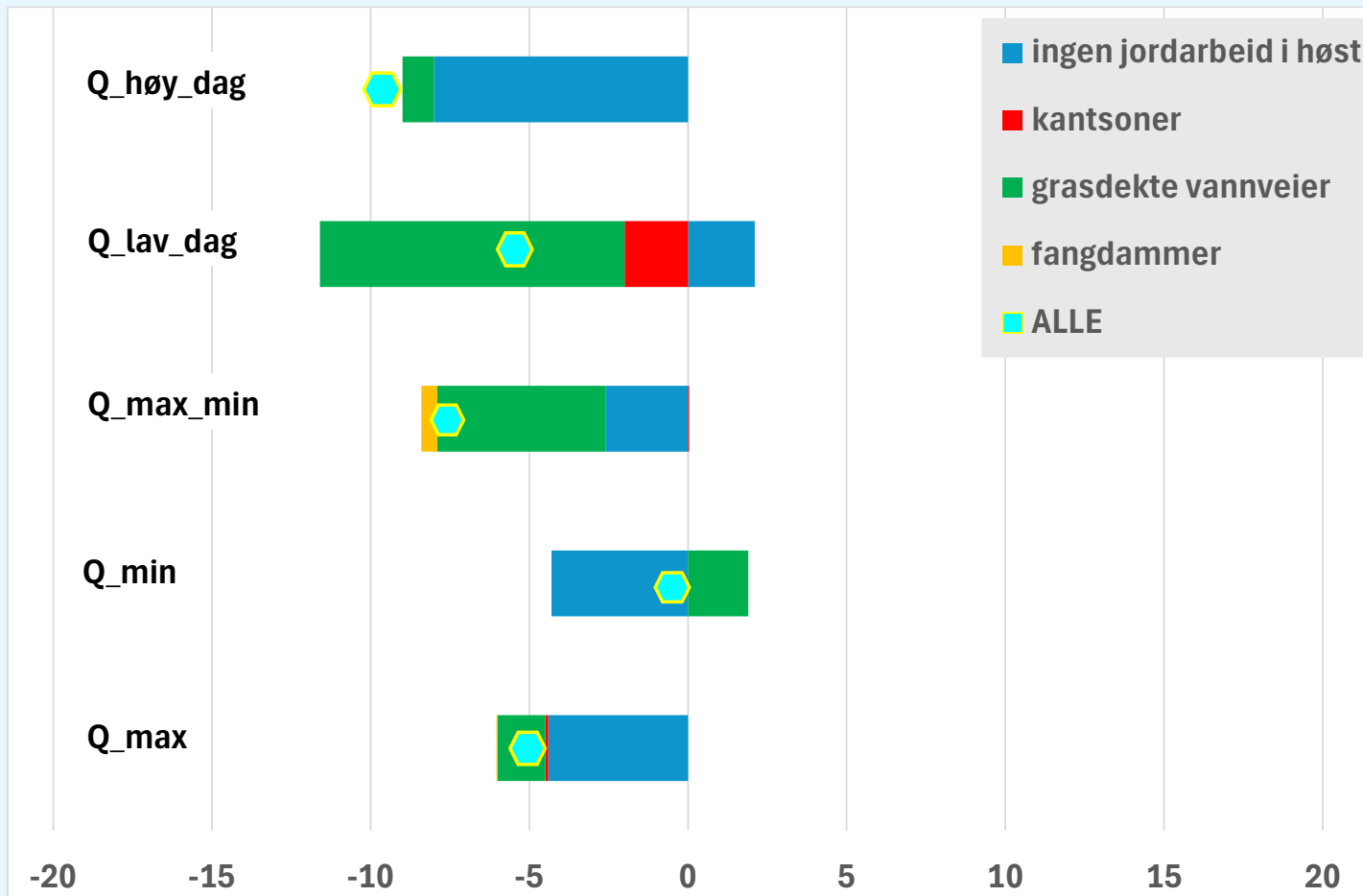

indikatorer	tiltakstyper				
	ingen jordarbeid i høst	kantsoner	grasdekte vannveier	fangdammer	ALLE
antall dager med høy vannføring	↓		↓		↓
antall dager med lav vannføring	↑	↓	↓		↓
Q_min: minimum vannføring	↓		↑		↓
Q_max: maksimal vannføring	↓	↓	↓		↓
forskjell mellom Q_max og Q_min	↓		↓	↓	↓

Q_høy_dag: antall dager med høy ($>Q_{p05}$) vannføring
 Q_lav_dag: antall dager med lav ($<Q_{p90}$) vannføring
 Q_max_min: forskjell mellom maks og min Q

Relative endringer i jordvanninnhold i forhold til basisperioden (%)

– tiltakseffekter ved maksimalt implementeringsnivå

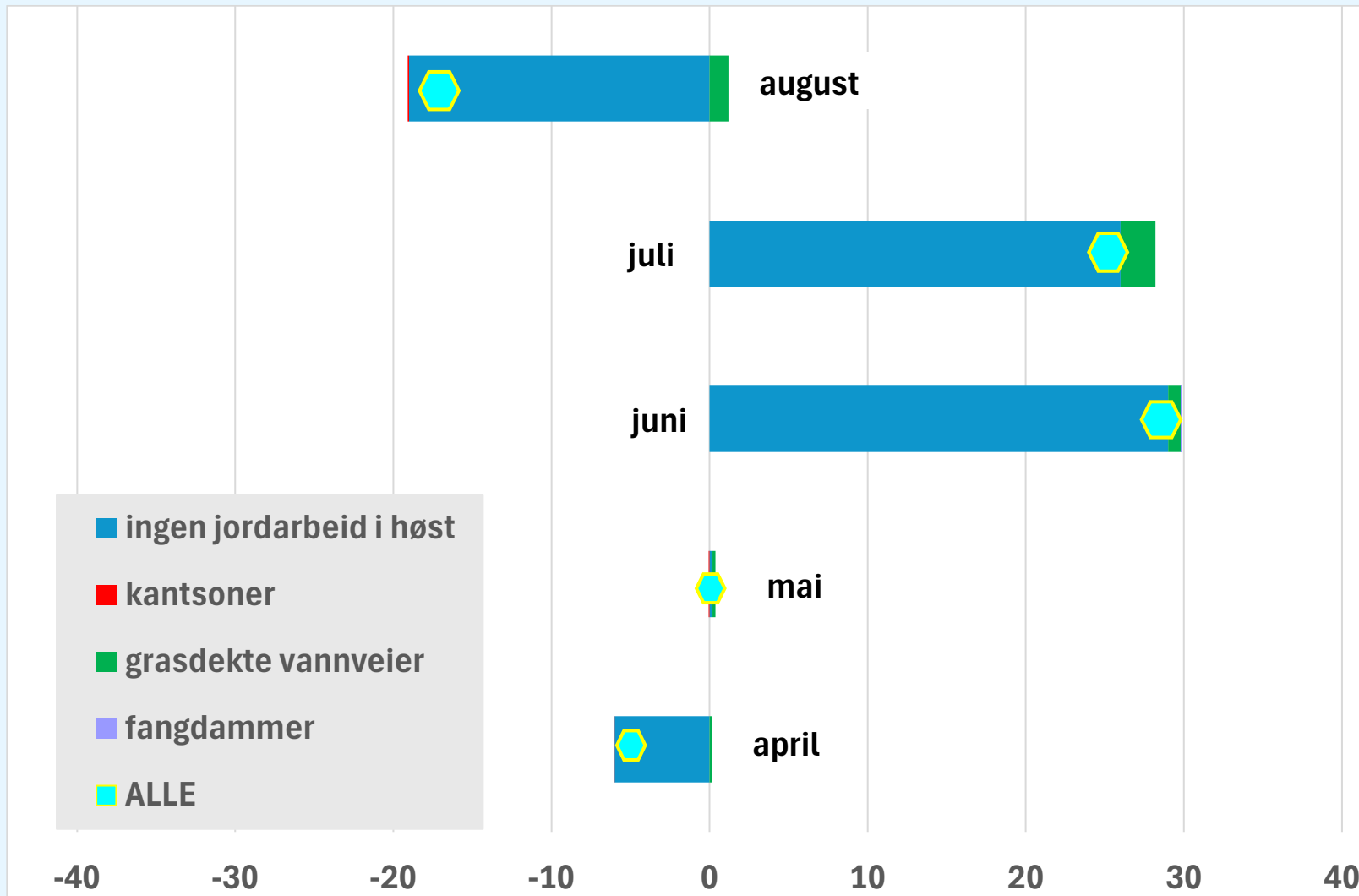

Vanninnholdet i jorda	tiltakstyper				
	■	■	■	■	■
APRIL	↓				↓
MAI					
JUNI	↑		↑		↑
JULI	↑		↑		↑
AUGUST	↓		↑		↓

Relative endringer i tap av jordpartikkel og næringsstoffer fra feltene i forhold til basisperioden (%) – tiltakseffekter ved maksimalt implementeringsnivå

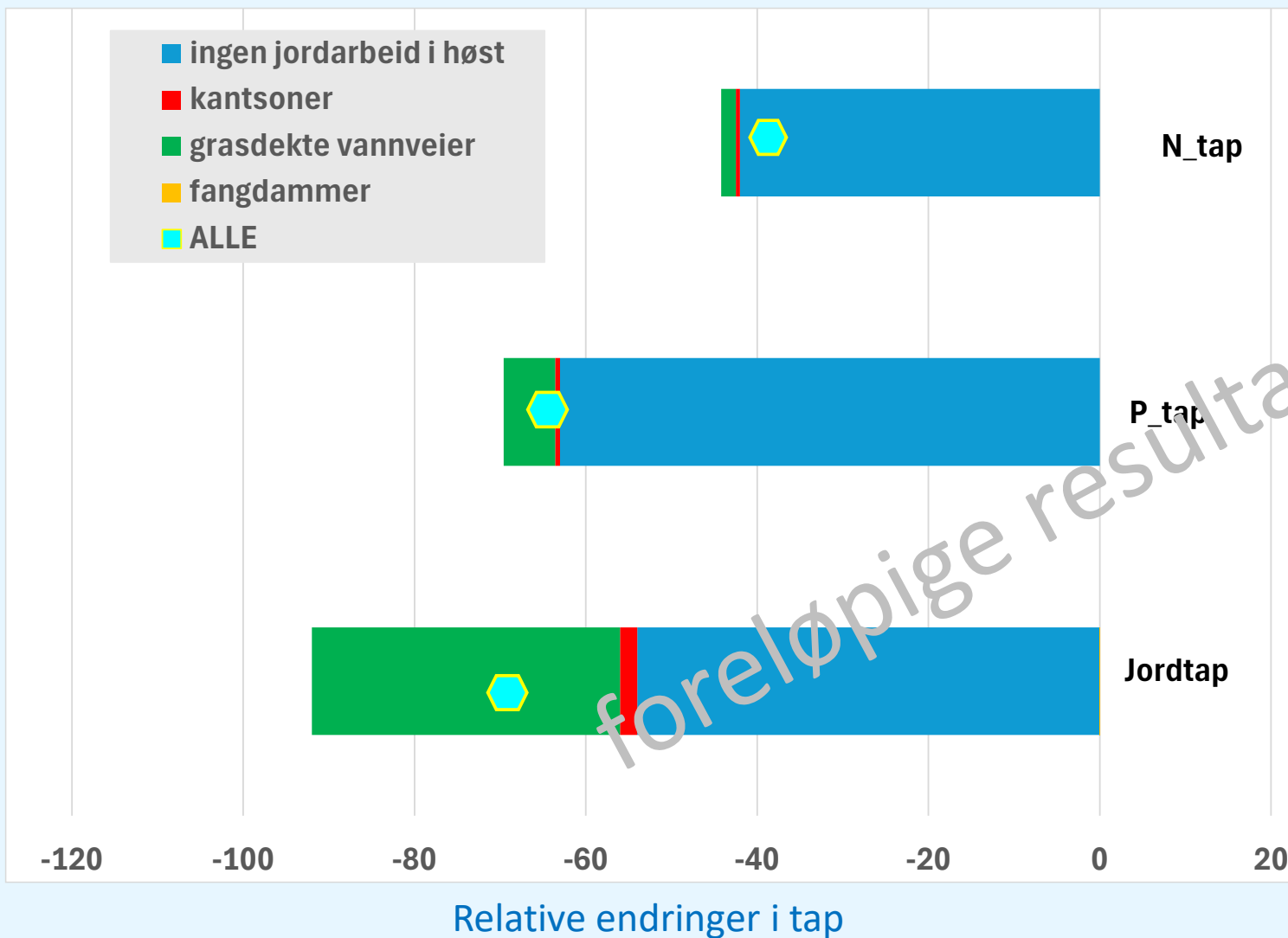

indikatorer	tiltakstyper				
	ingen jordarbeid i høst	kantsoner	grasdekte vannveier	fangdammer	ALLE
N-tap	↓	↓			↓
P-tap	↓	↓	↓		↓
Jordtap	↓	↓	↓		↓

foreløpige resultater

Demonstrasjon av usikkerhet i modelleringsresultater

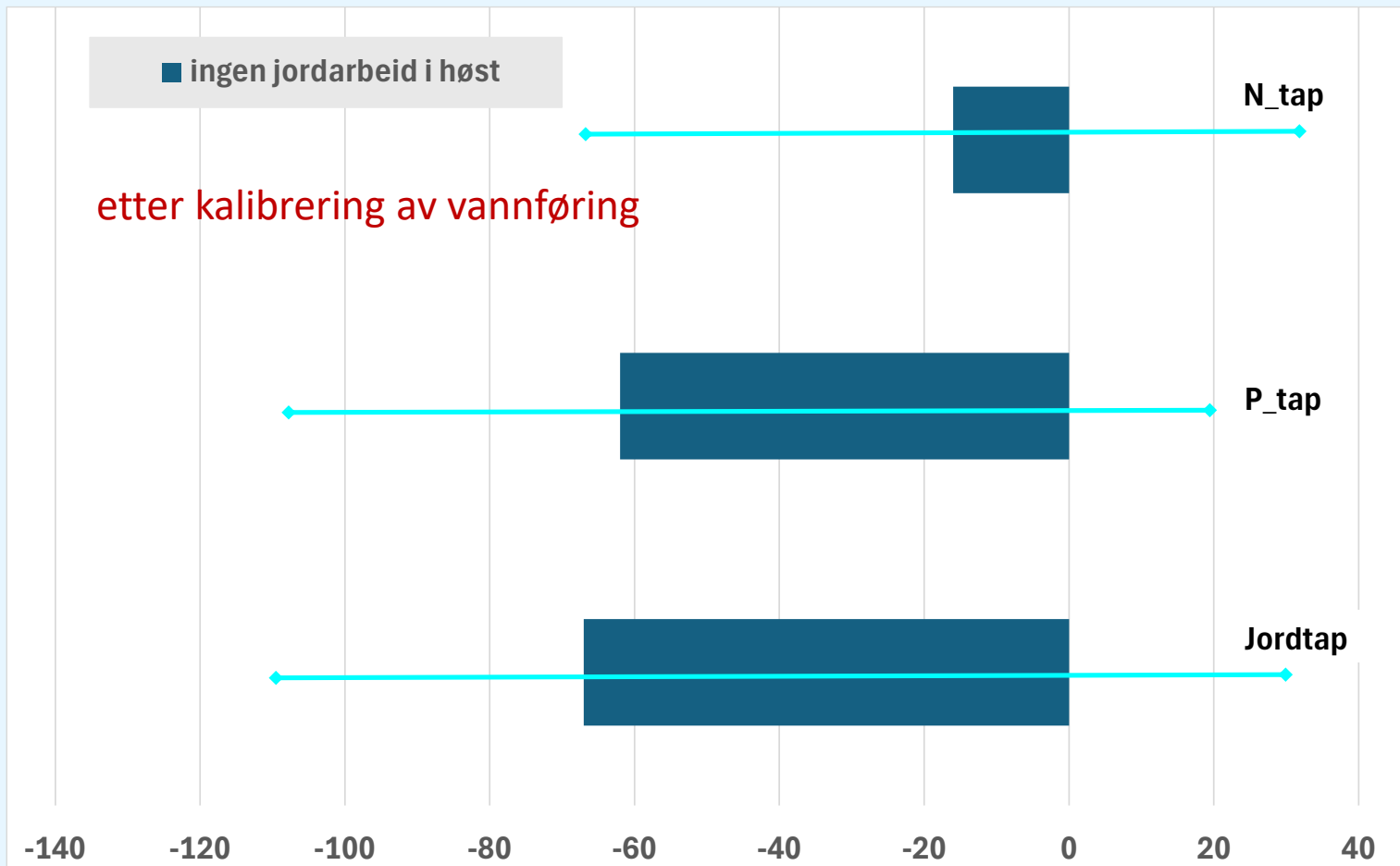

Kilder av usikkerhet:

- Usikkerhet i inngangsdata
- Tidsmessige endringer i parametere (f.eks. jordegenskaper etc.)
- Romlig variabilitet av parametere
- Forenklinger i modellstruktur/ligninger
- Forutsetninger som ble gjort under oppsett av modellen
- Usikkerhet i referansedata

Demonstrasjon av usikkerhet i modelleringsresultater

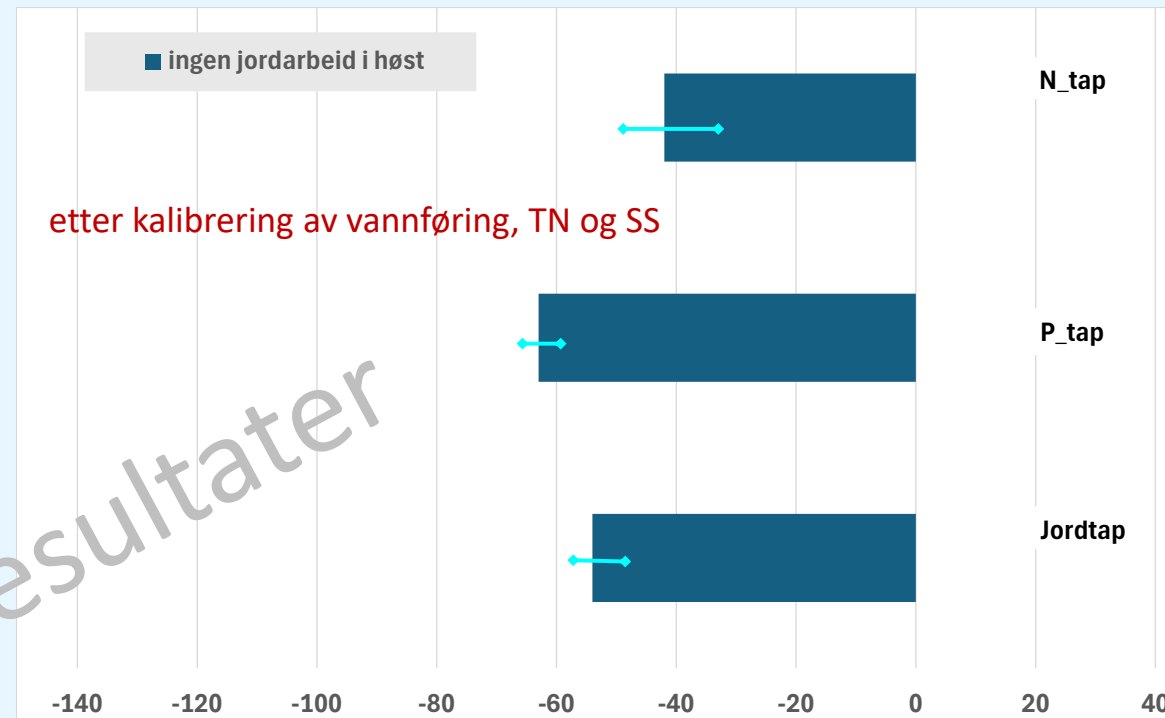
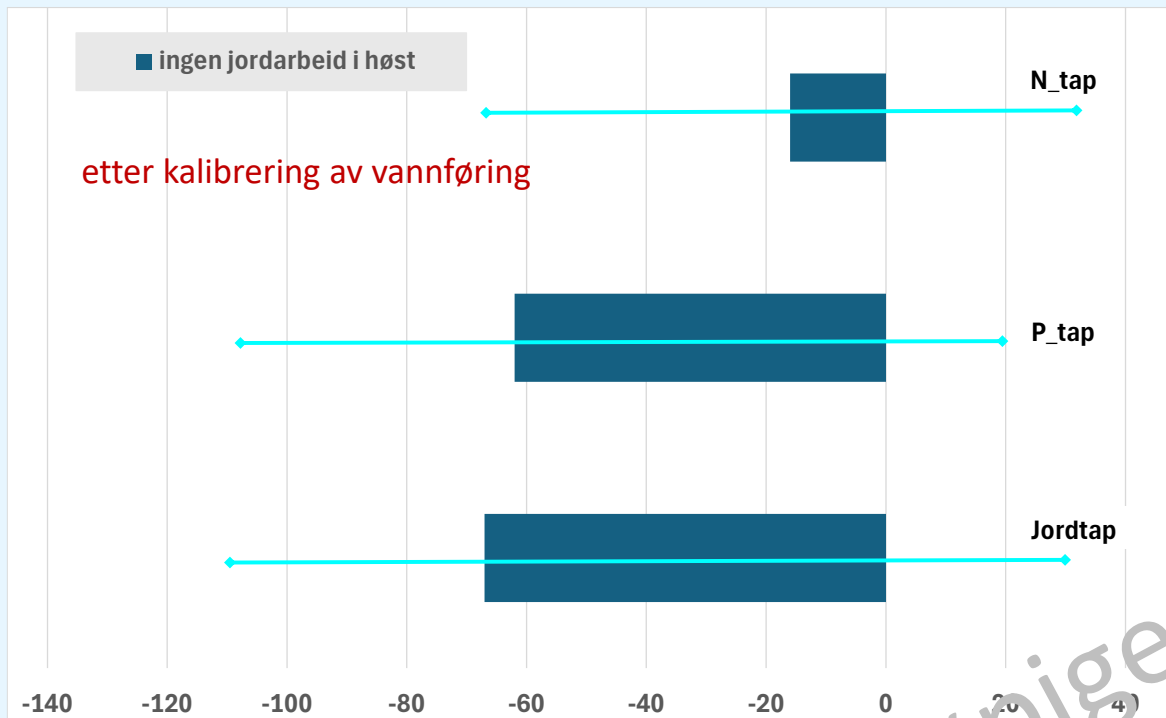

foreløpige resultater

Relative endringer i de hydrologiske parameterne i forhold til basisperioden (%)

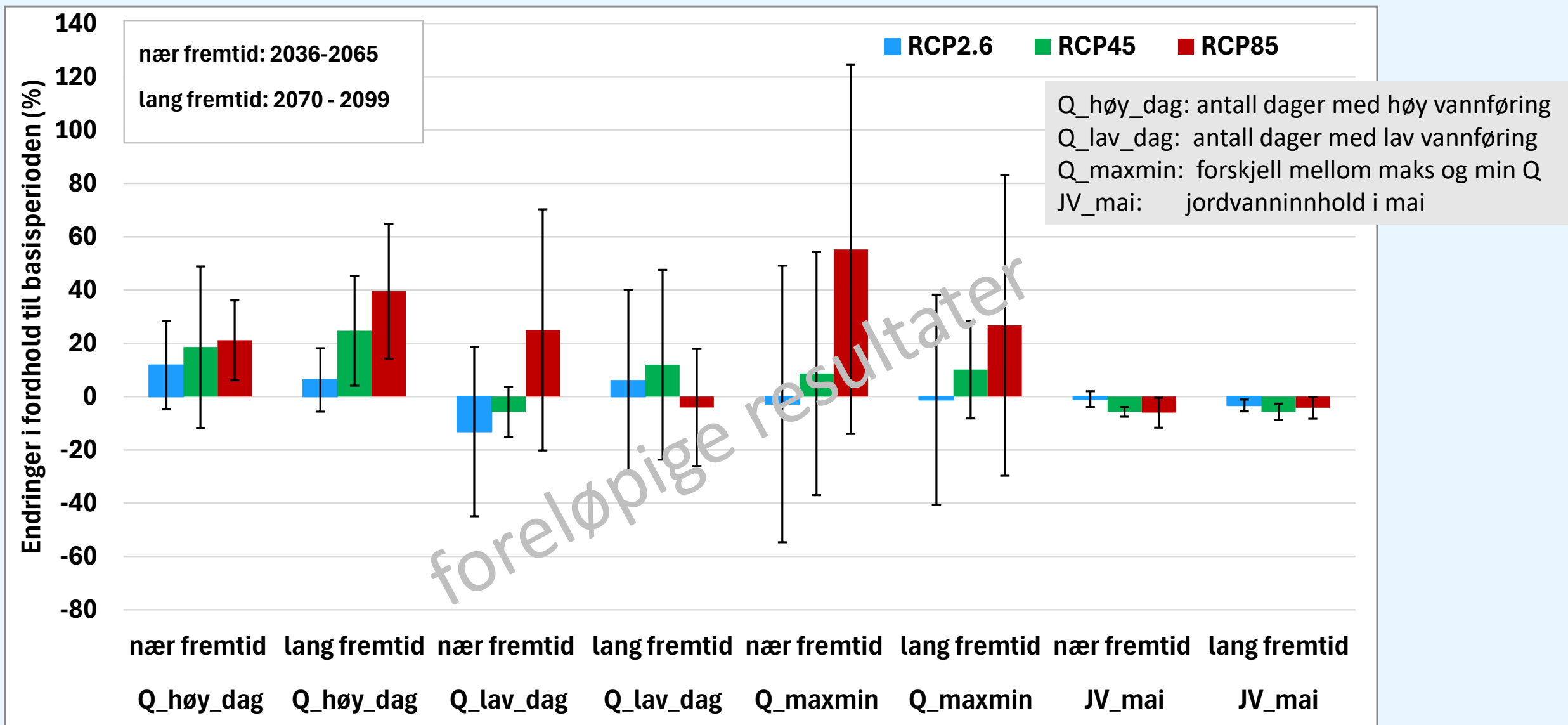

Relative endringer i tap av jordpartikkel og næringsstoffer i forhold til basisperioden (%)

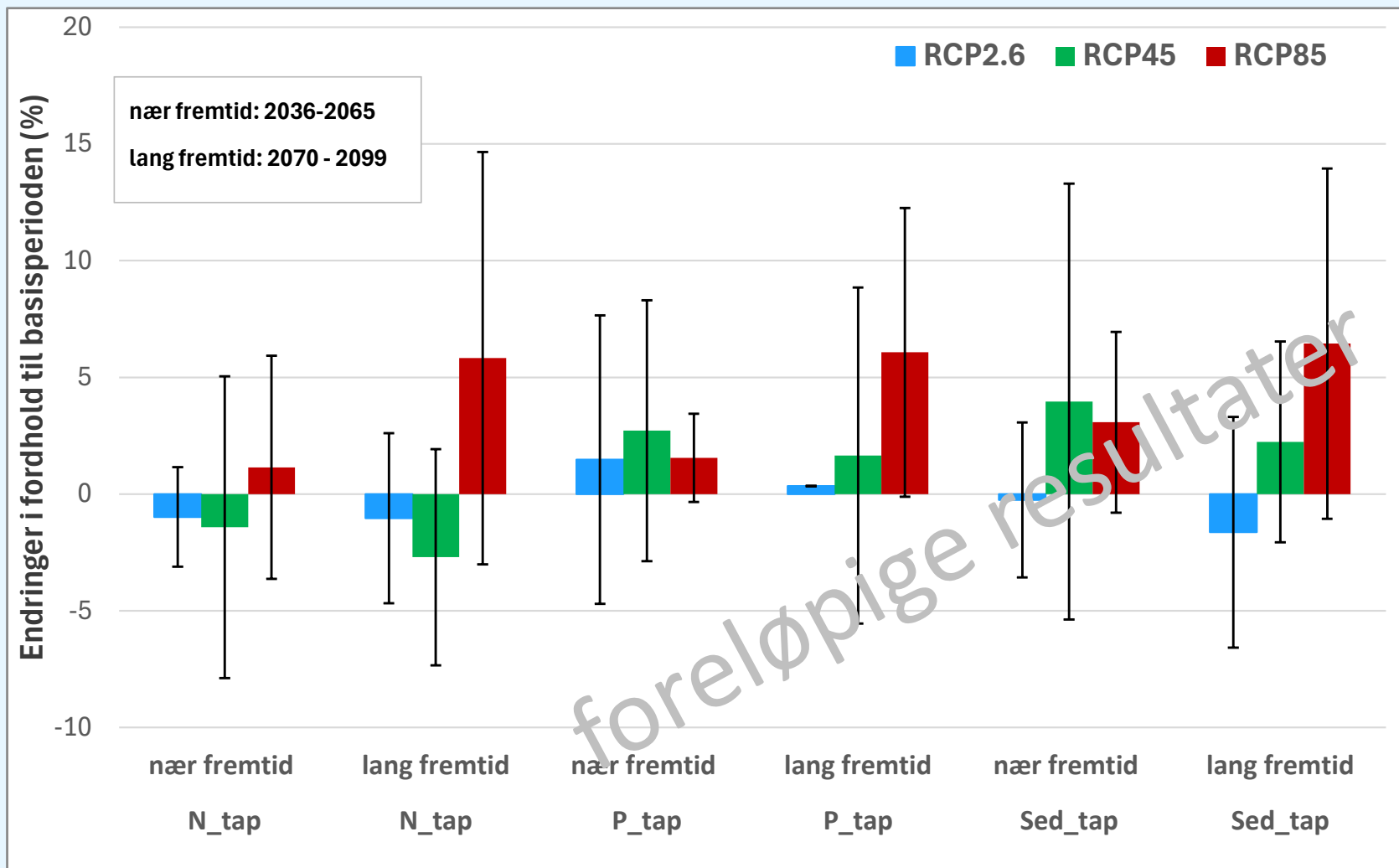

Kilmascenarier		Indikatorer		
		N-tap	P-tap	Jordtap
RCP2.8	nær fremtid	↓	↑	
	lang fremtid	↓		↓
RCP4.5	nær fremtid	↓	↑	↑
	lang fremtid	↓	↑	↑
RCP8.5	nær fremtid	↑	↑	↑
	lang fremtid	↑	↑	↑

foreløpige resultater

Relative endringer i tap av jordpartikkel i forhold til basisperioden (%)- ingen jordarbeid i høsten

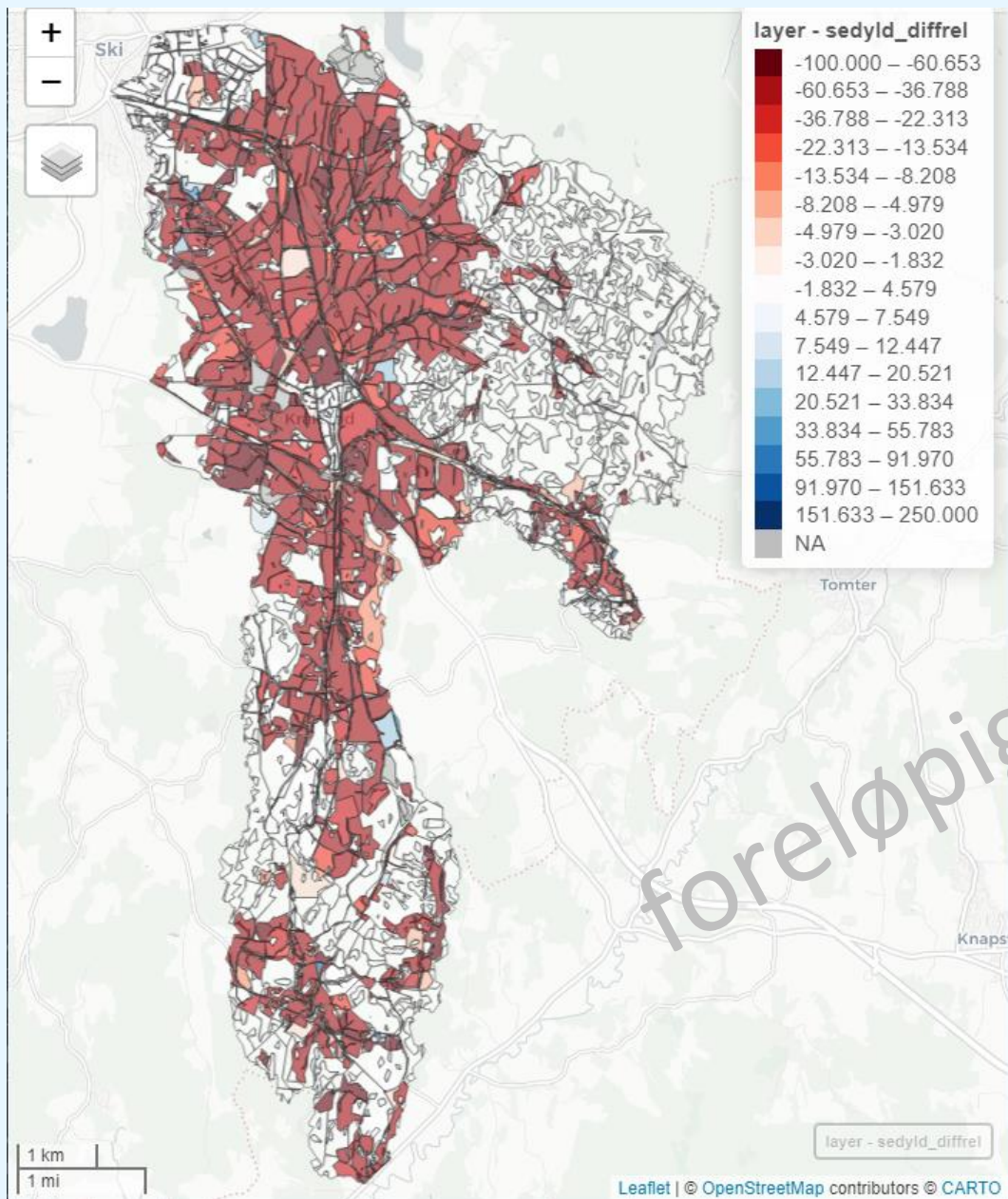

Relative endringer i N som kommer inn i kanalen i forhold til basisperioden (%)- ingen jordarbeid i høsten

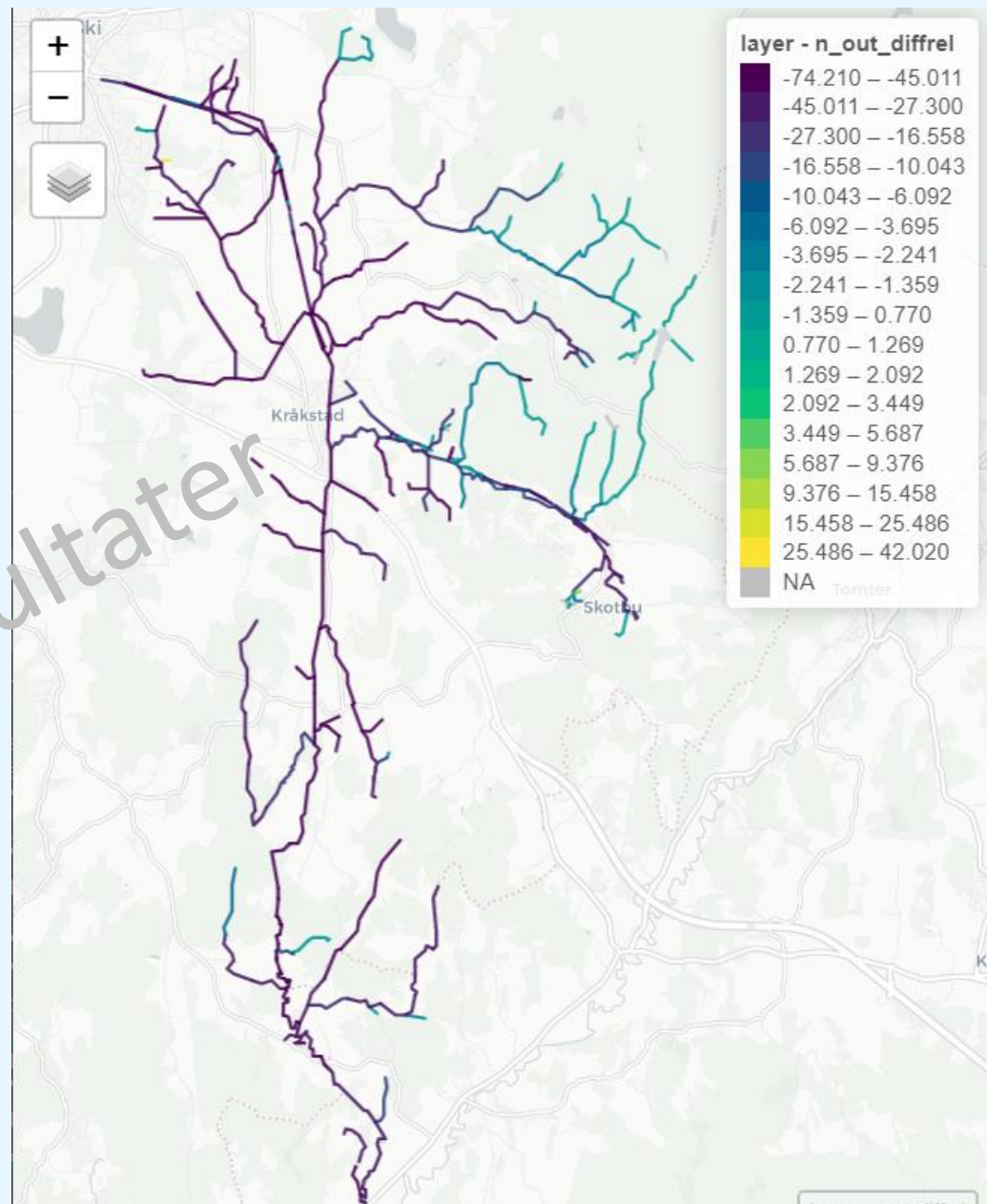

Relative endringer i tap av jordpartikkel i forhold til basisperioden (%)- grasdekte vannveier

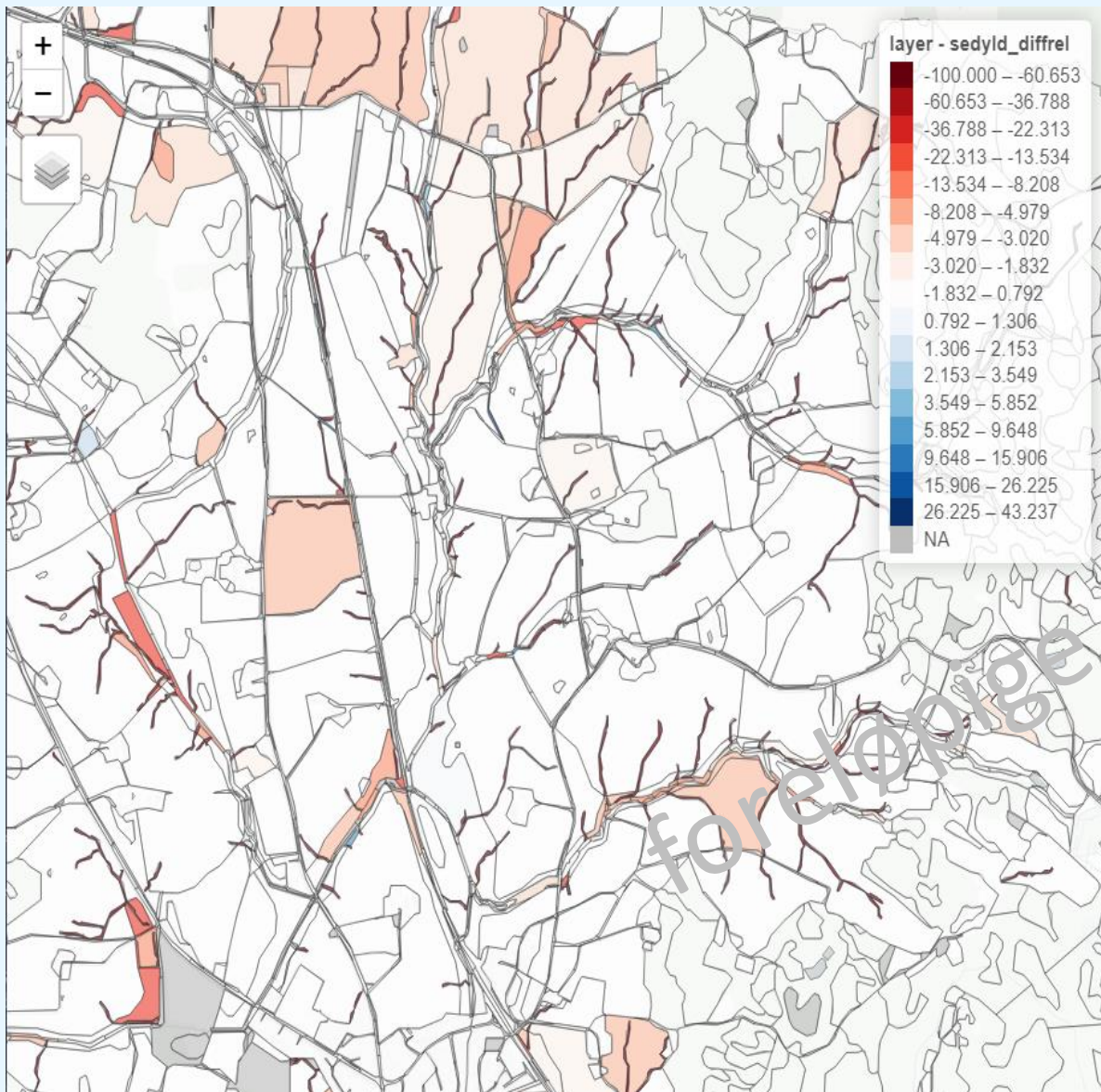

Relative endringer i tap av jordpartikkel i forhold til basisperioden (%)- kantsoner

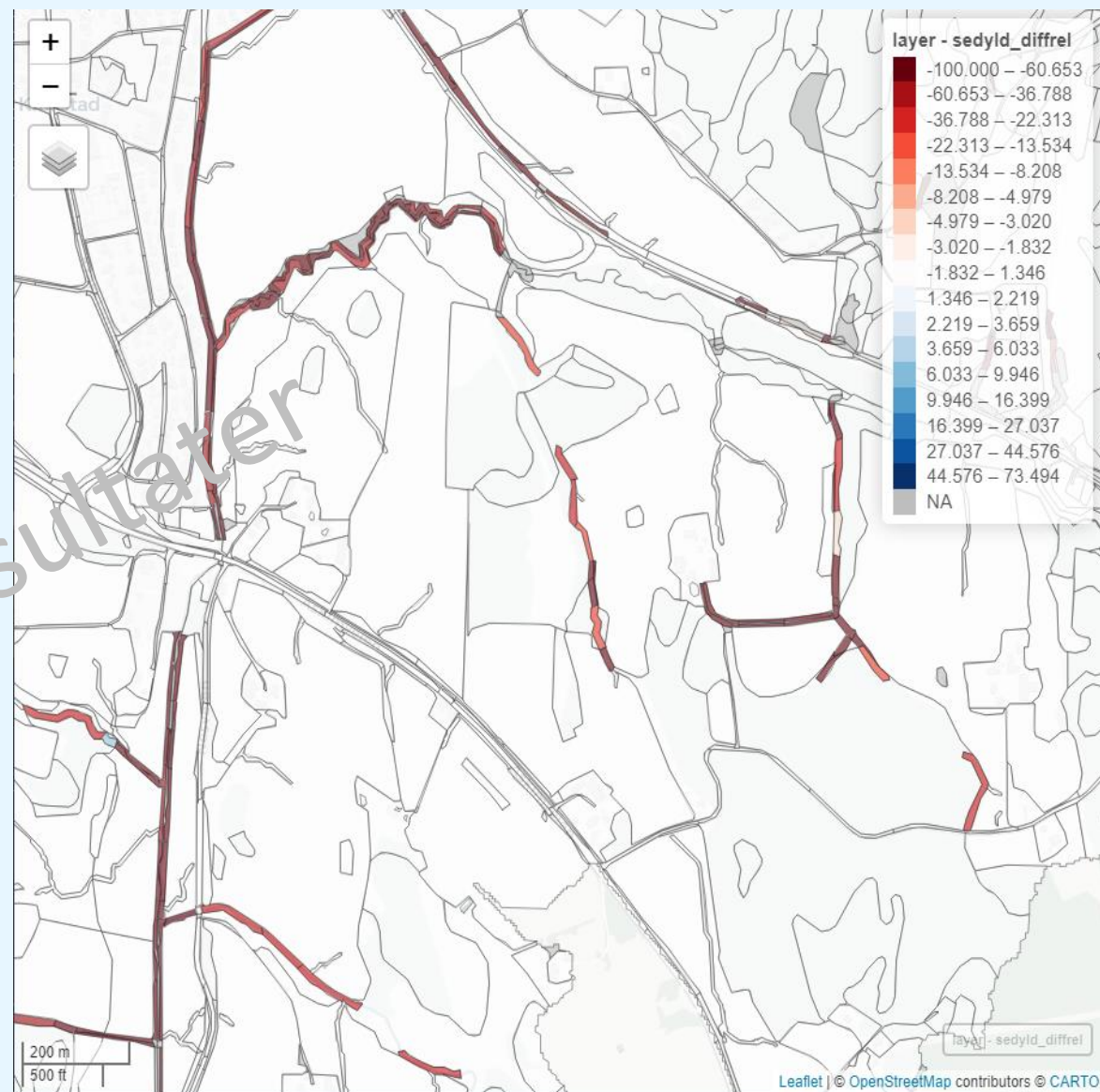

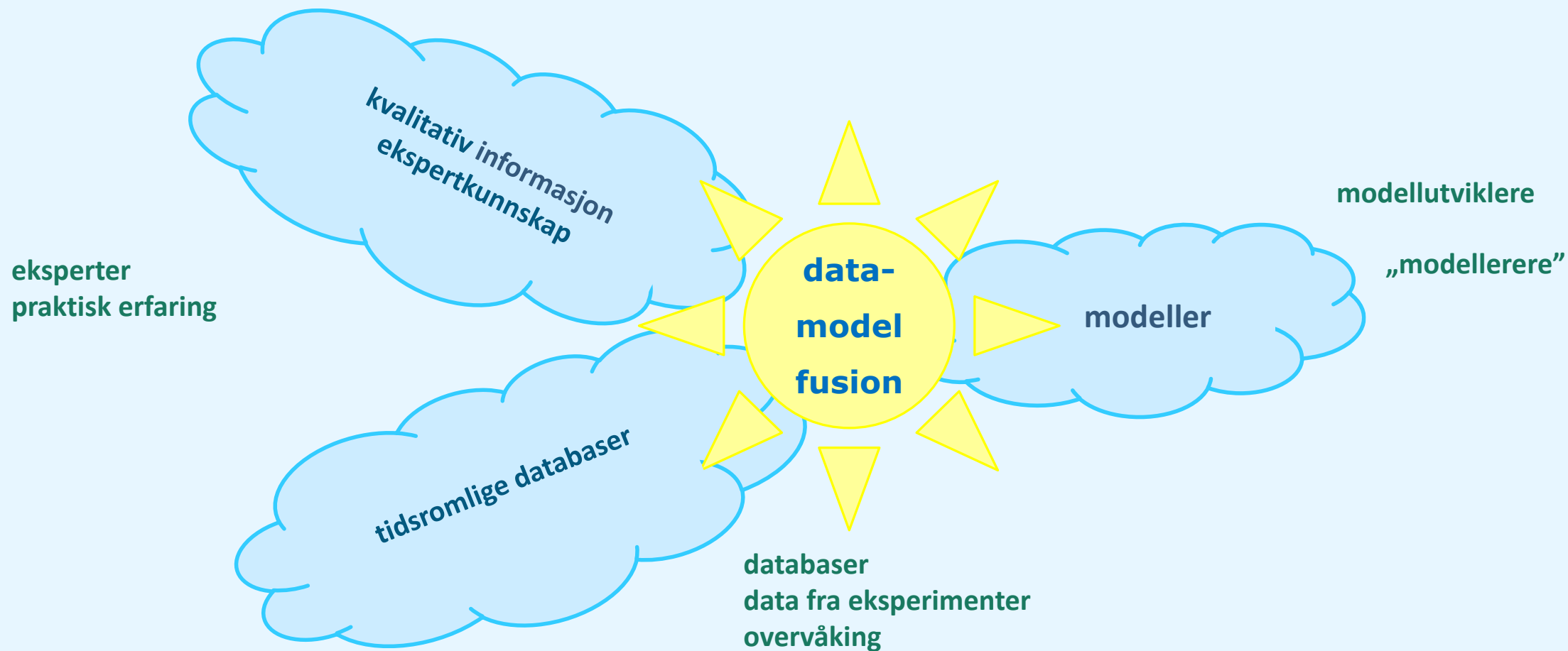

Modellering er et samarbeid

VI VIL GJERNE VITE DIN MENING

- Hva synes dere om simulerte effekter av ulike tiltak
- Hva synes dere om simulerte effekter av klimaendringen
- Hvilke tiltak som skal implementeres i SWAT+ modellen for Hobølelva
- Hvilke hydrologiske indikatorer er av hovedinteresse
- Hvilke vannkvalitet indikatorer er av hovedinteresse

THANK YOU FOR YOUR ATTENTION!



Hobøelva; Copyright: Copyright Kjetil Palmquist



ECOSAFE har arbeidspakker om

MILJØTILTAK og VIRKEMIDLER (politikk)

I denne halvtimen ser vi på

- › noen eksempler fra Finland, Sverige, Danmark og Polen...
- › ...og på hva som har skjedd her hjemme i det siste.
- › Og diskutere: Hva trenger vi (mer?) av virkemidler og tiltak

Juridiske og økonomiske virkemidler

Flere lover og forskrifter regulerer jordbruksdrift ut fra miljøhensyn. Økonomiske virkemidler omfatter ordninger med tilskudd til miljøtiltak hvor brukeren får økonomisk kompensasjon for en aktiv miljøinnsats.

LES MER ↓

 Virkemidler

PUBLIKASJONER



Foto: Eva Skarbøvik

Vassdraget Vantaanjoki:

- Jordbruksdominert vassdrag som drenerer ut ved Helsinki
- Klassifisert som stor leireelv
- Helsinki bruker vann fra Vantaa som reserve-vannforsyning.



Finland: Vantaanjoki

Tiltak:

- Jordbruksareal tatt ut av bruk: Brakkland.
- Gipsbehandling av jorda
- Redusert bruk av gjødsel
- Plantedekke om vinteren (enten miljøbasert jordarbeiding eller fangvekster)
- Fangdammer, våtmarker

Virkemidler:

- Regulering av gjødselbruk
- Gipsbehandling – prosjekt med 76 gårdsbruk og mange tusen hektar.
Økonomiske virkemidler: det har vært gratis for bønder å få jorda behandlet med gips

Finland: Vantaanjoki nærmer seg miljømålet for TP på 60 $\mu\text{g/l}$

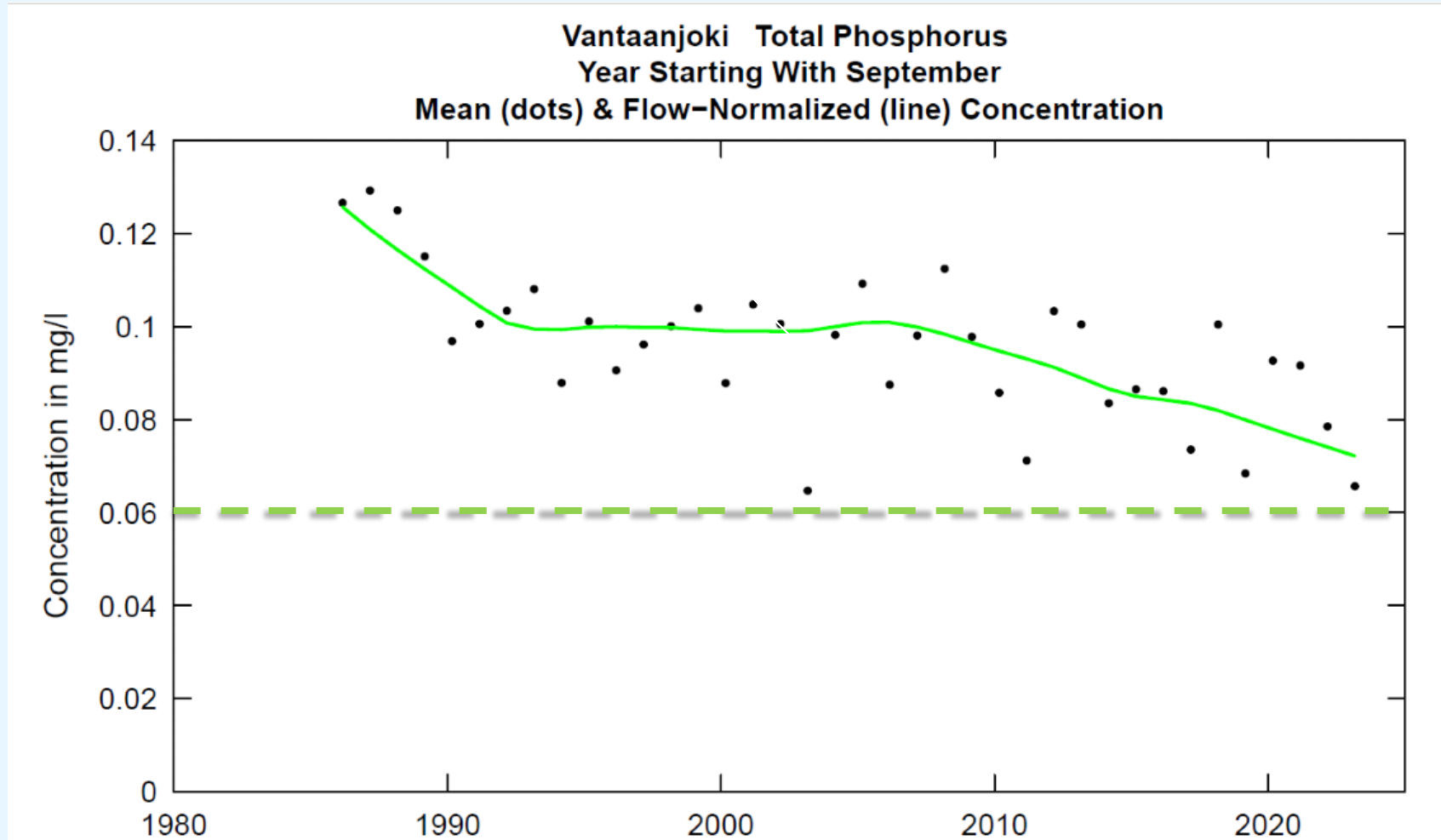

Gipsbehandling??

- › Mattilsynet vil ikke tillate bruk av gips som jordforbedringsmiddel. Hovedårsaken er nok risikoen for økt frigjøring av fosfat fra sedimentene i innsjøer nedstrøms.
- › Gips brukes i store mengder (størrelsesorden 400 kg/daa). Da tilføres veldig mye sulfat.
- › I innsjøer hvor det kan oppstå anaerobe forhold i bunnsedimentene kan det skje at utløst jern felles med svovelet som jernsulfid. Mengden bindingsplasser for fosfor blir dermed redusert.
- › I Finland tilføres ikke gips til arealer der det er en innsjø nedstrøms med mer enn 10 dagers oppholdstid.
- › Kalkingsmidler er dermed mindre risikofylt å bruke som jordforbedringsmiddel enn gips (forutsatt at jorda ikke har en høy pH i utgangspunktet).
- › Finland har store berg av gips etter fosfatproduksjon, og dette er nok en av årsakene til den omfattende bruken av gips der.

Sverige:

To små jordbruksfelt
(tenk JOVA) med ulike
jordtyper, klima og
produksjonssystemer



Sverige: Tiltak og virkemidler

To små jordbruksfelt med ulike jordtyper, klima og produksjonssystemer

N34 i sørvest

Tiltak

Fangvekster– men mer areal frem til 2010 enn etter

Jordarbeiding om våren

Gjødsling om våren

Virkemidler

P-gjødsel: max 22 kg/ha (snitt over 5 år)

Markdekke om vinteren 60%

Tilskudd

Rådgivingsprogram

C6 i øst (Örsundaån)

Tiltak

Kantsoner

Markdekke

Gjødsling

Virkemidler

P gjødsling: max 22 kg/ha (snitt over 5 år)

Markdekke om vinteren 50%

Tilskudd

Rådgivingsprogram



Responsen i Sverige:

N34 i sørvest

Sandig permeabel jord

Nedbør: 700 mm

Flere typer vekster

Husdyrtetthet: 0.3 enheter per

ha

*N er hovedproblem
Nedgang til 2010*

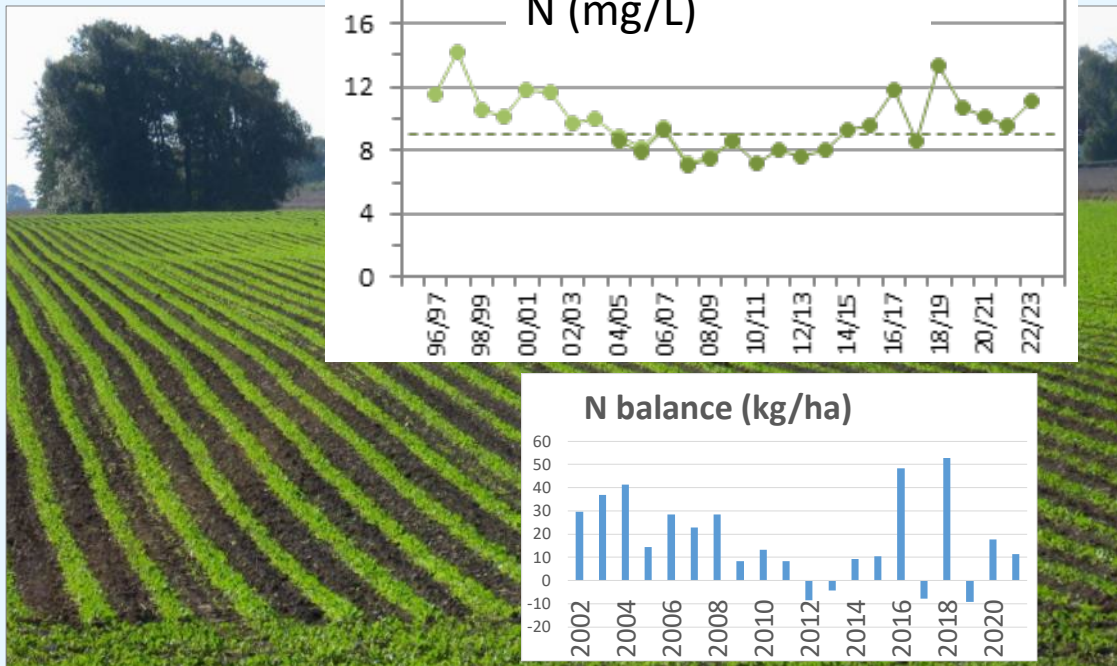

C6 i øst, innenfor Örsundaån nedbørfelt

Leirjord

Nedbør 550 mm

Kornproduksjon – lite endring i tiltakene. Mye klima som påvirker.

Husdyrtetthet <0.1 enheter per ha

P er hovedproblem

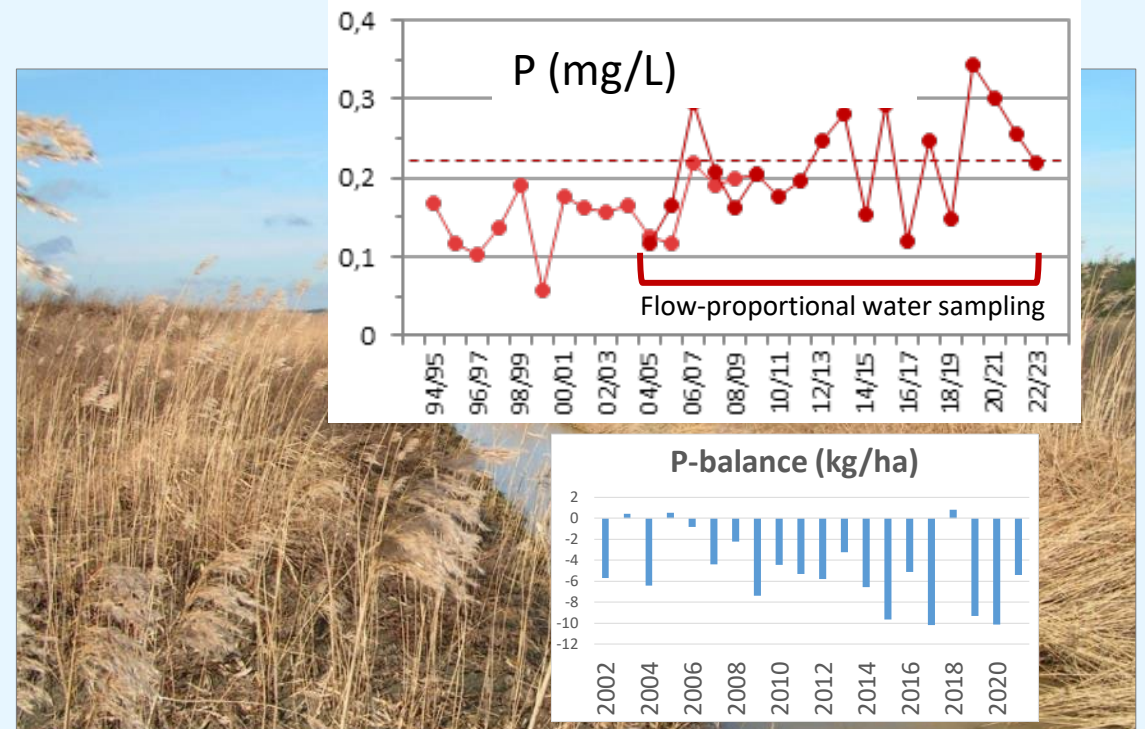

Odense elv (Odense Å)

Odense Å er Fyns længste elv. Ca 60 kilometer lang, med et nedbørfelt på 550 km². Den munner ut i Odense Fjord. Odense Fjord har problemer med overgjødning.



Nitrogentilførsler i Odense Å: fem ulike virkemidler

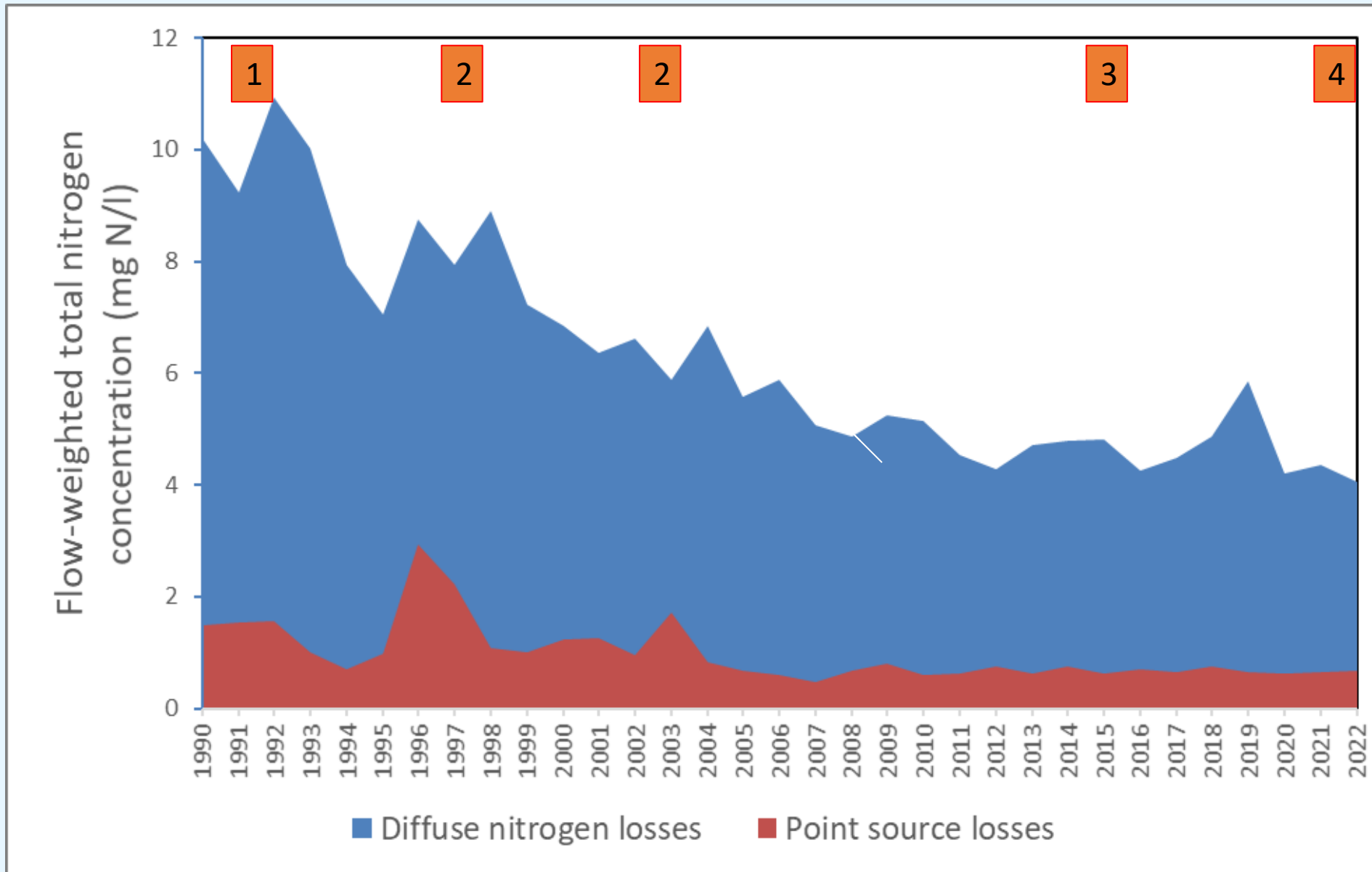

Nitrogentilførsler i Odense Å

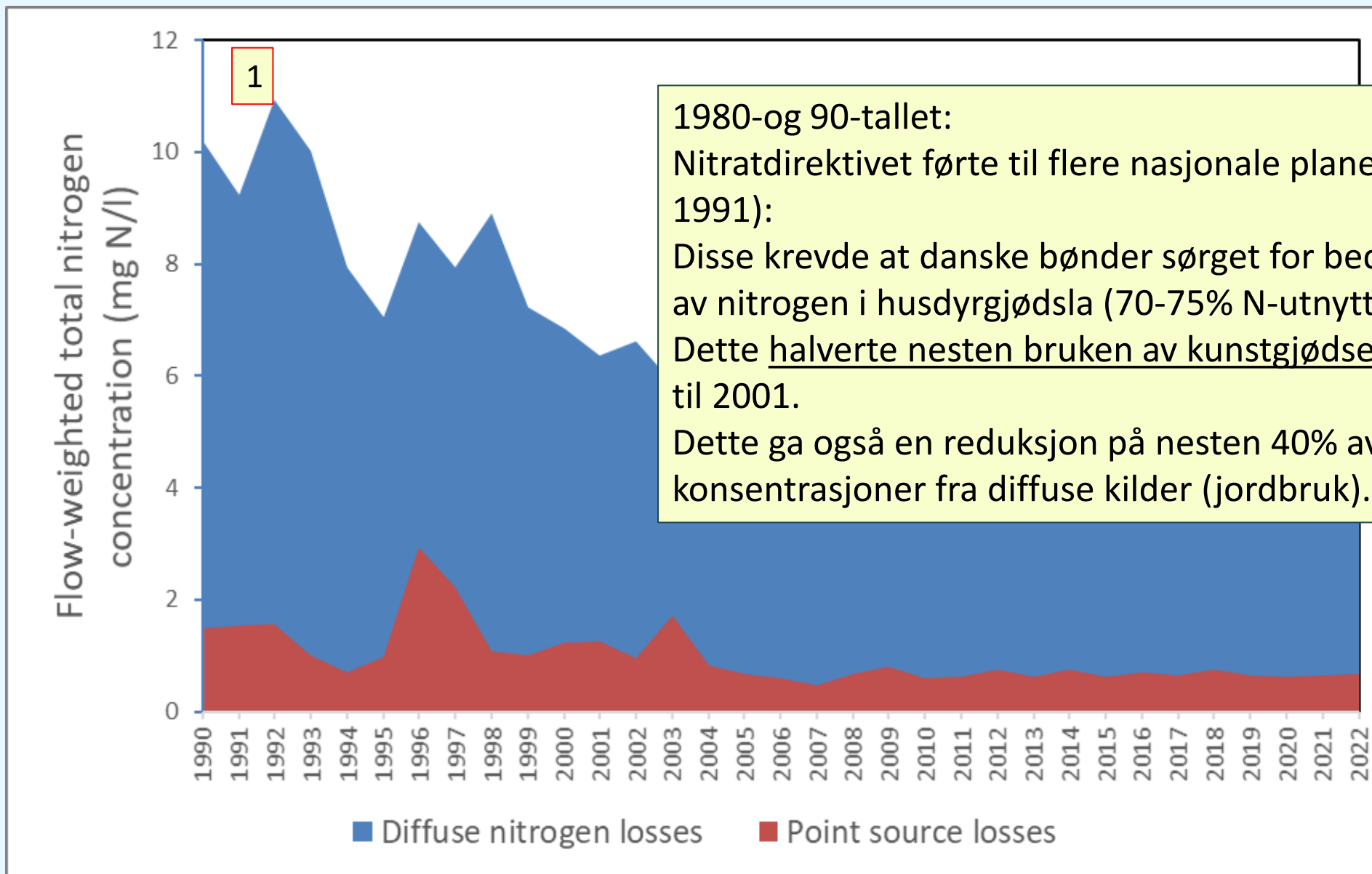

Nitrogentilførsler i Odense Å: reduksjon

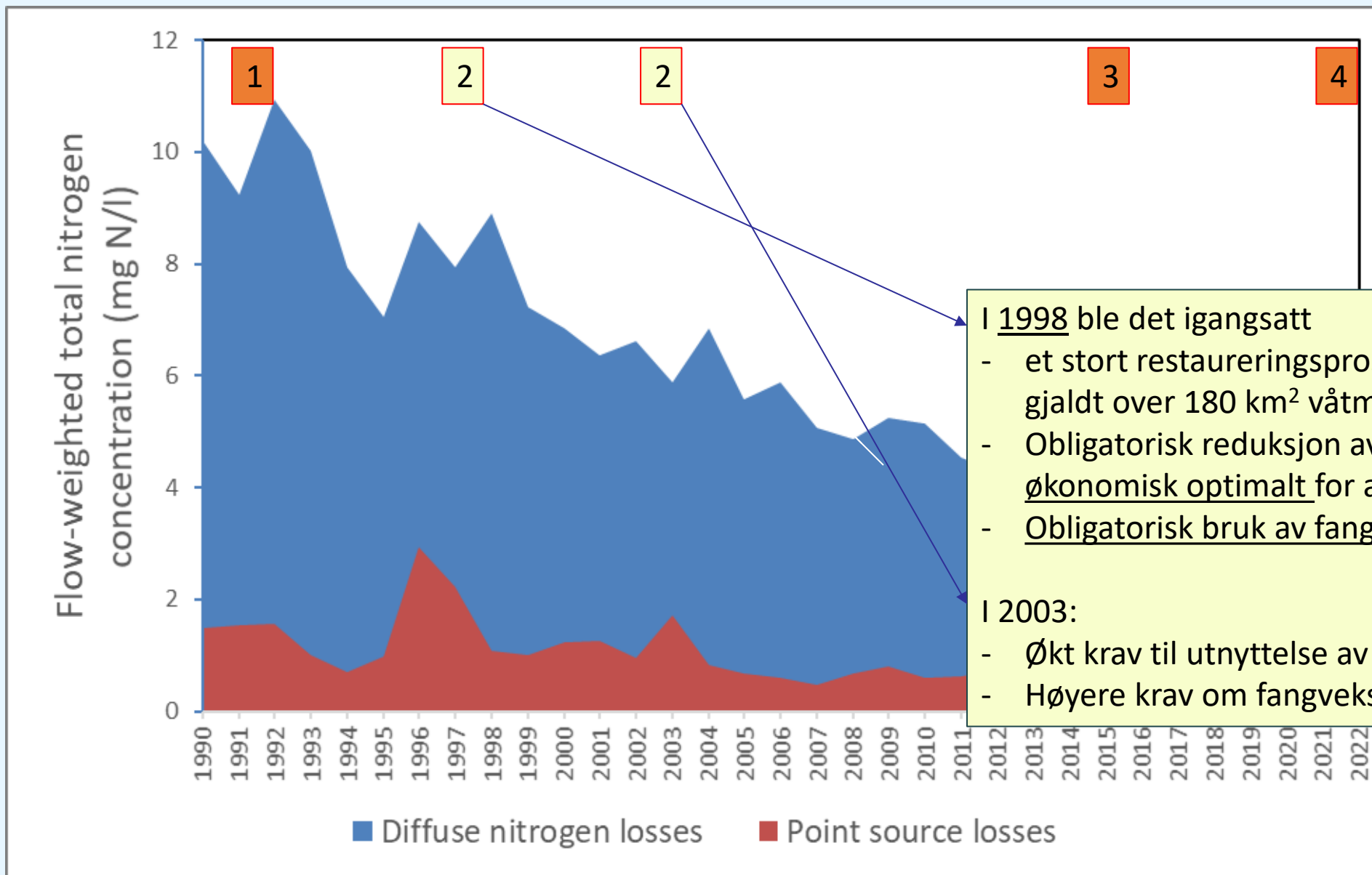

I 1998 ble det igangsatt

- et stort restaureringsprosjekt for våtmarker, gjaldt over 180 km² våtmark.
- Obligatorisk reduksjon av gjødsling (10% under økonomisk optimalt for alle typer vekster).
- Obligatorisk bruk av fangvekster.

I 2003:

- Økt krav til utnyttelse av N i husdyrgjødsel
- Høyere krav om fangvekster

Nitrogentilførsler i Odense Å: reduksjon

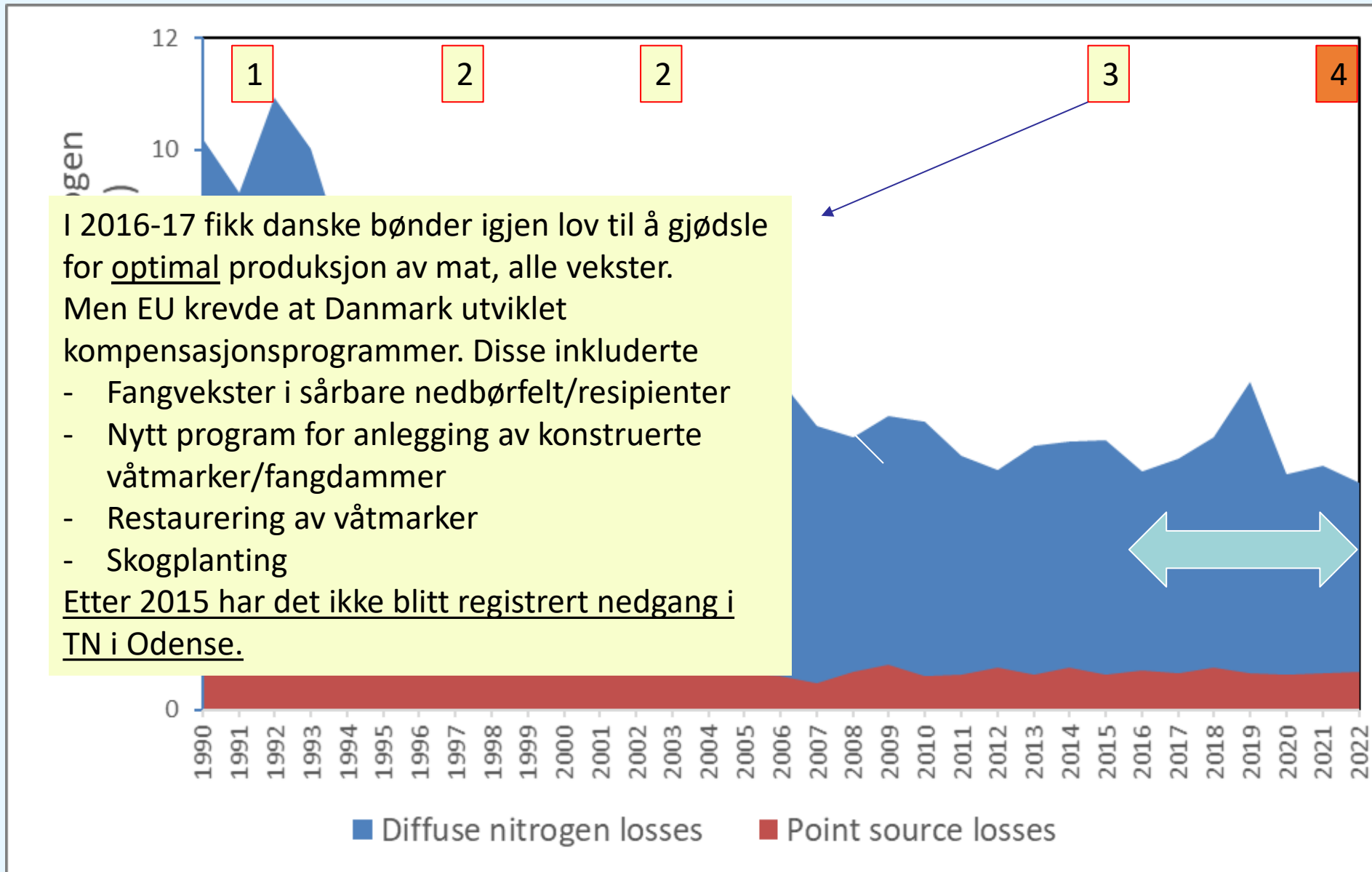

Nitrogentilførsler i Odense Å: reduksjon

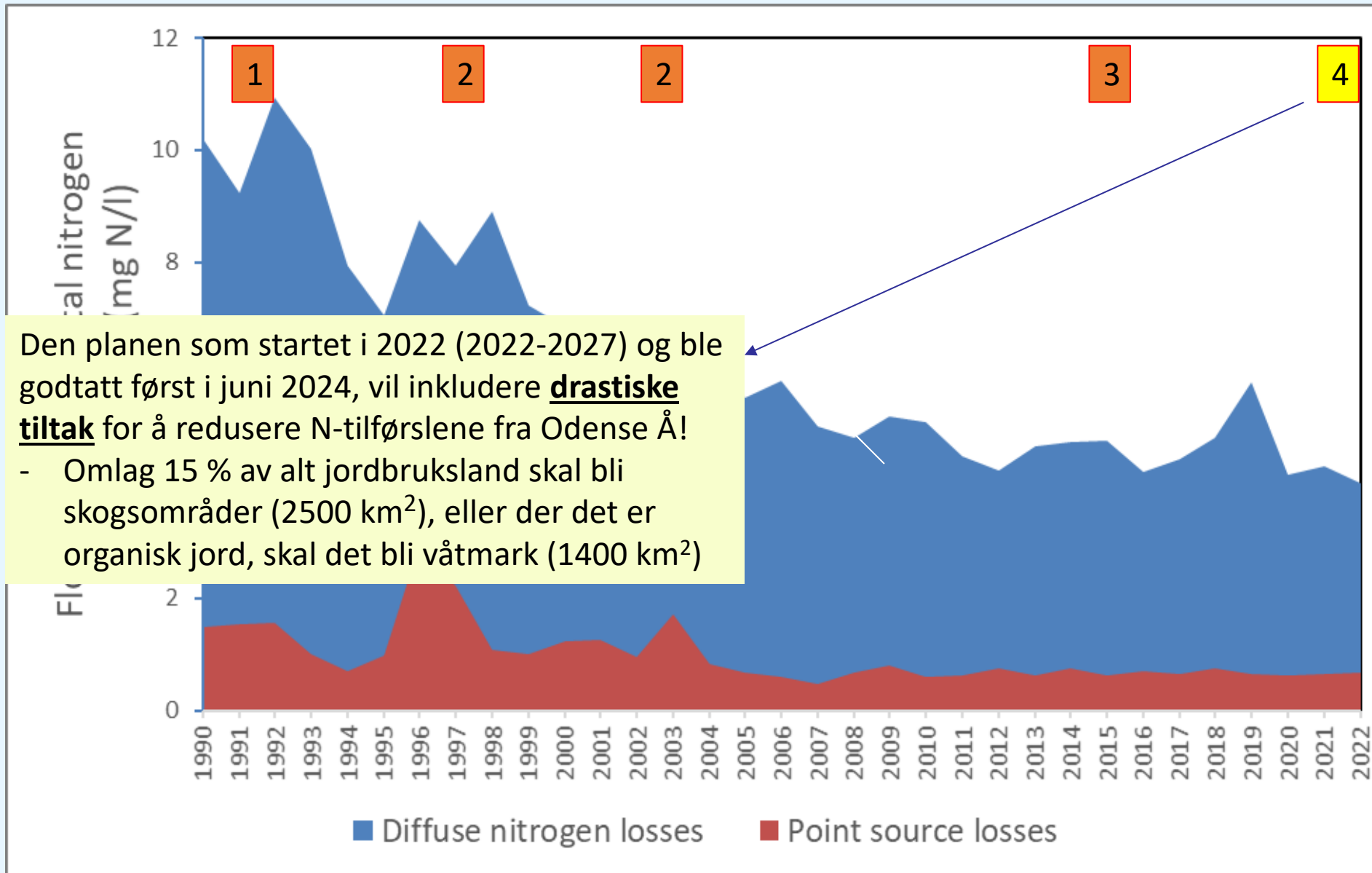

Poen: Słupia

Słupia er en elv som renner ut i Østersjøen, med en lengde på 138 kilometer og et nedbørfelt på ca. 1500 km².

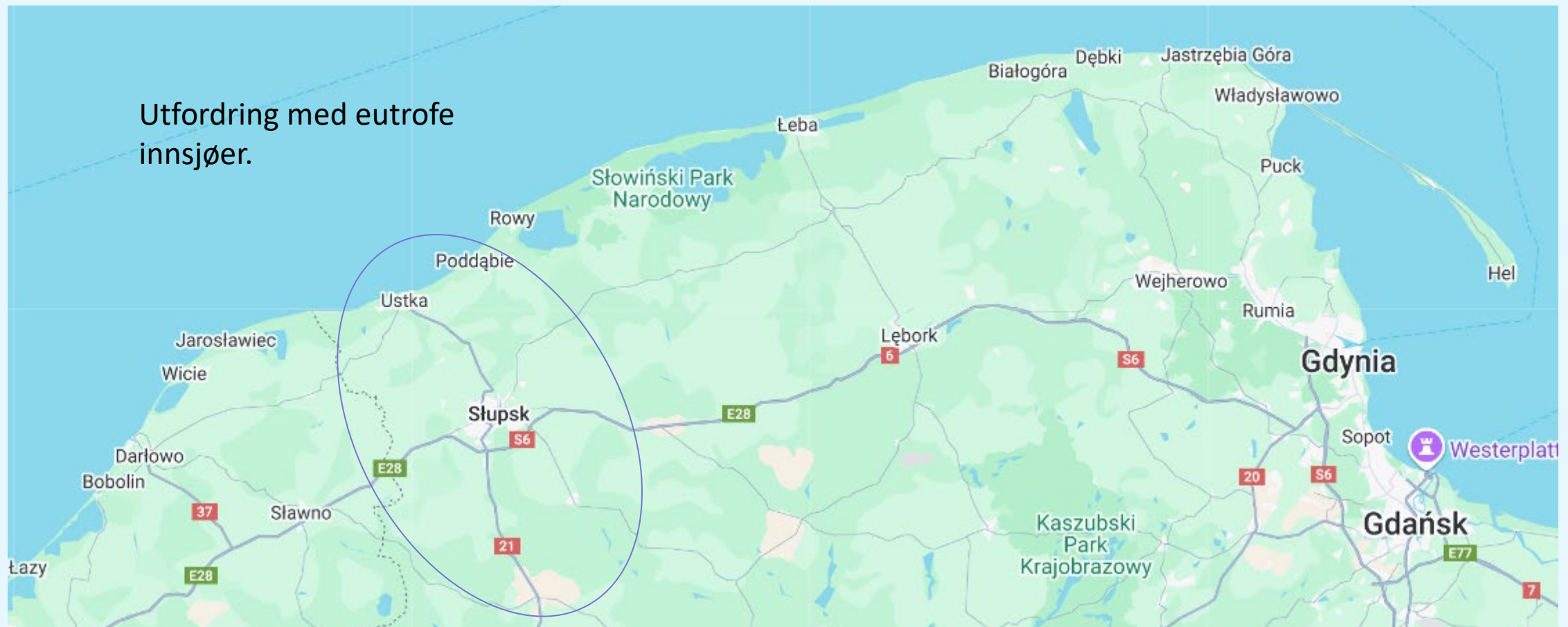

Polen

For det meste er det renseanlegg for kloakk som har virket, Dessuten vaskemidler uten P!

Så kom EUs vanndirektiv som også hjalp

Men mange land som grenser til Østersjøen jobber fortsatt med å få ned næringsstofftilførslene.

Jordbruket har hatt en særegen utvikling, fra kooperativene før jernteppet falt ca. 1990, via ekstensivt landbruk, fulgt av nye strukturer

Effekten av tiltak etter EU er vanskelig å se siden de i mange år var frivillige.

I perioden 2014-2020 (Rural Development Plan 2014-2020) ble det intensivering av noen tiltak som skogplanting, kantsoner, men effektene foreløpig ikke synlige.

Nye øko-tiltak i 2023 er lovende.

Polen: Słupia river

Det som har minsket mest i denne elva er punktkilder knyttet til kommunalt avløp

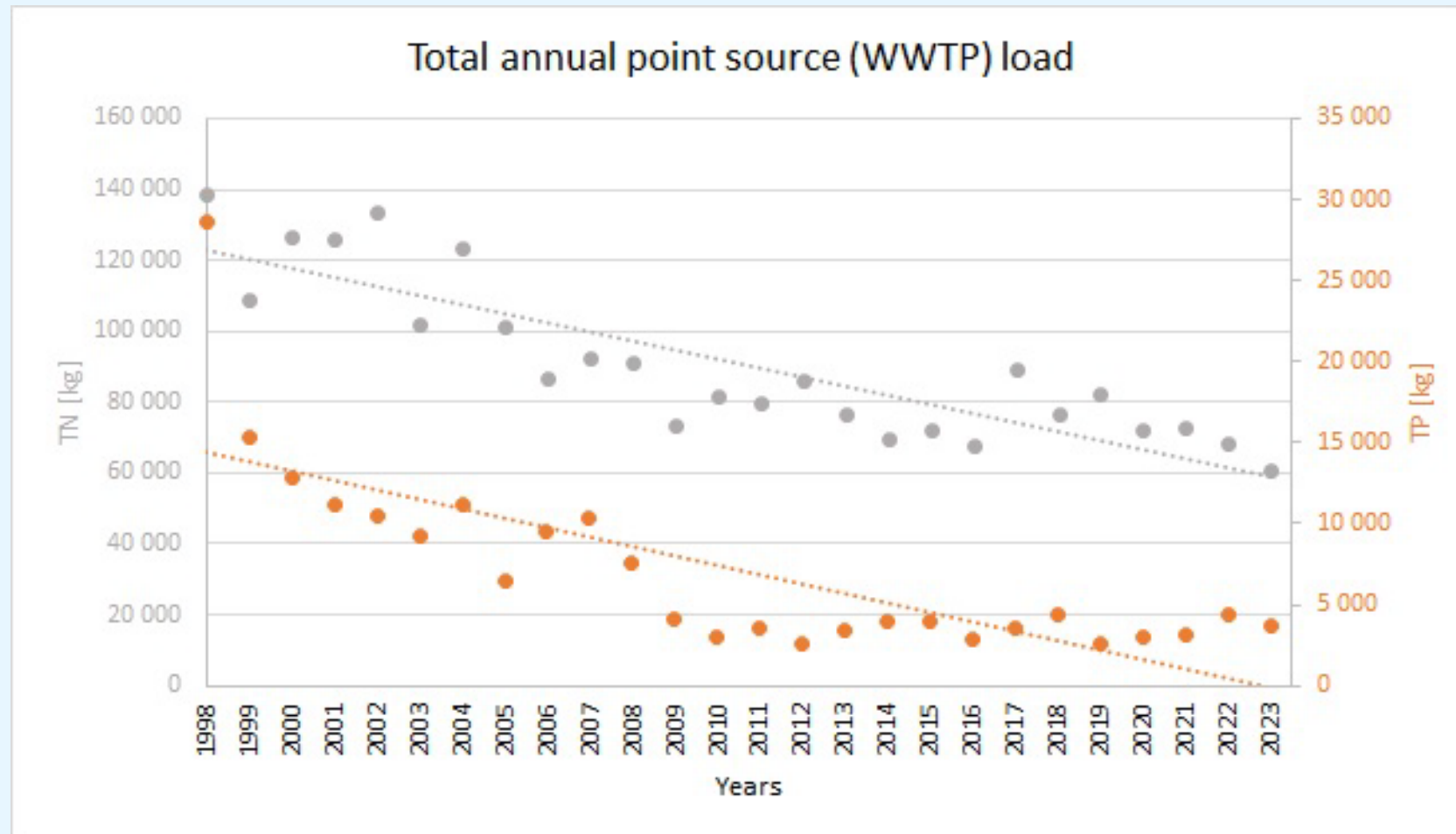

Polen: Słupia river

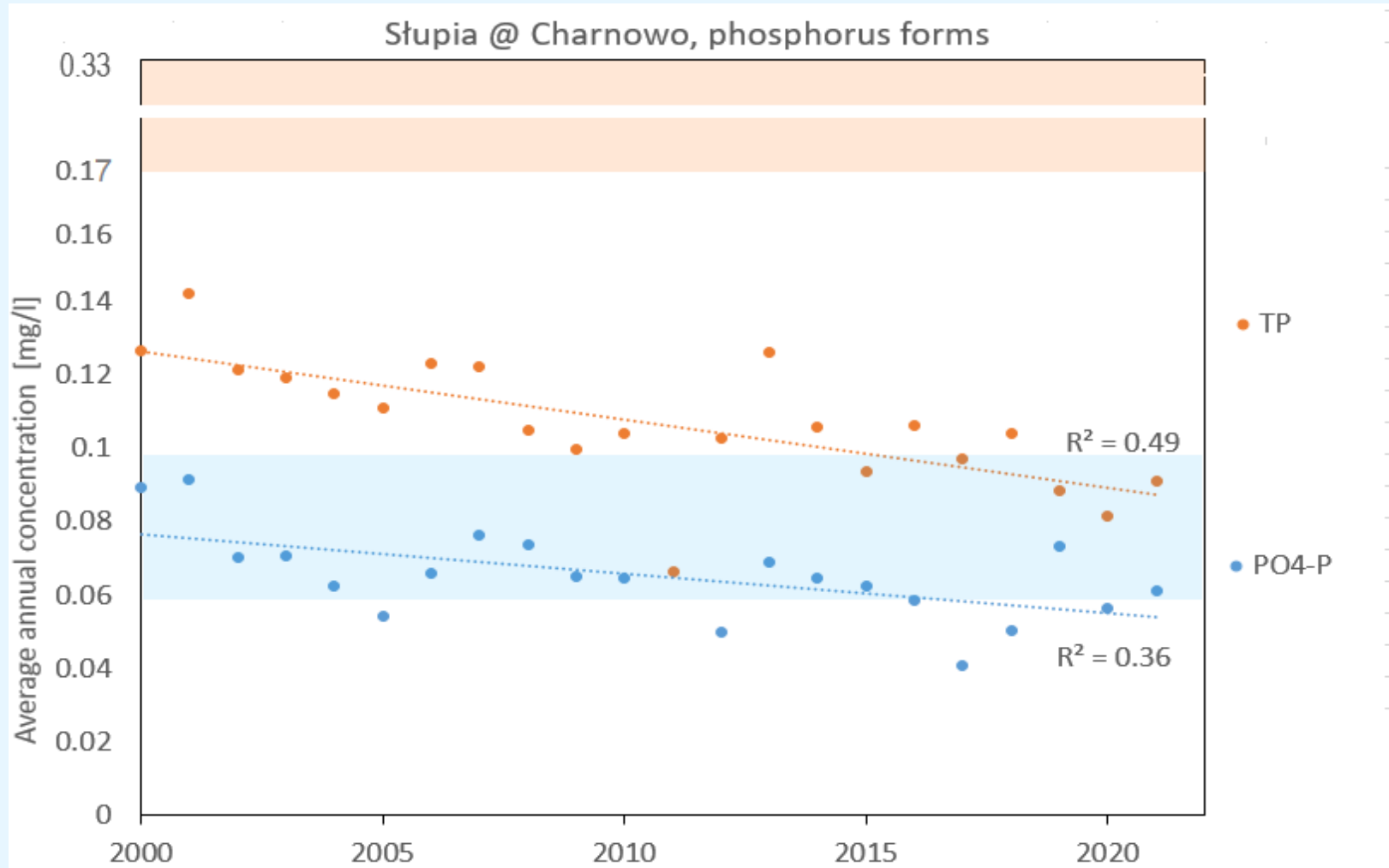

Charnowo is the most downstream-located monitoring site in the Słupia catchment.

Polen: Słupia river

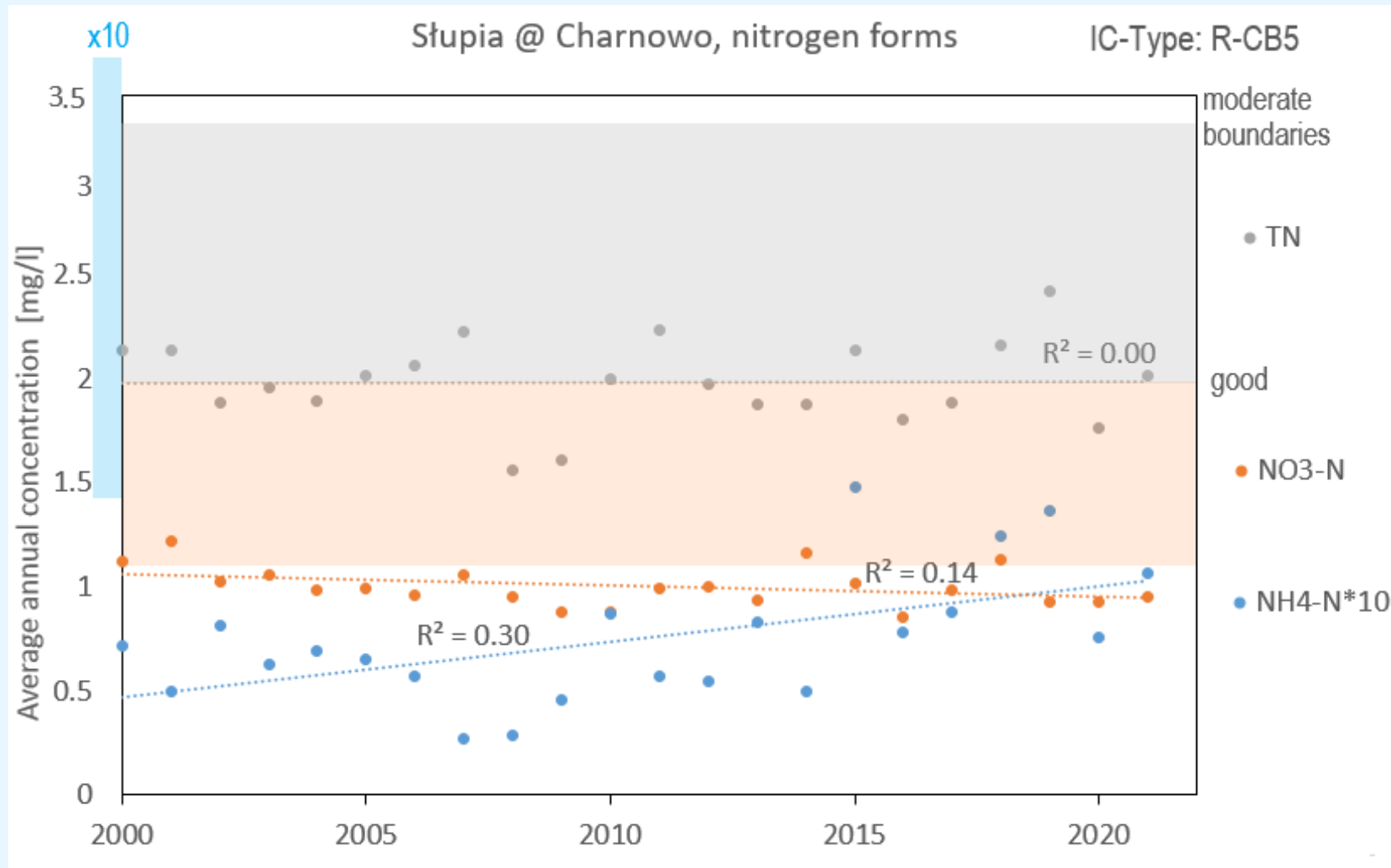

Charnowo is the most downstream-located monitoring site in the Słupia catchment.

Polen: Słupia - gjødsling

Data bare fra hvert 10 år.
Enten stabilt eller økning av gjødsling
(dårlige data).

Nmin kg/ha

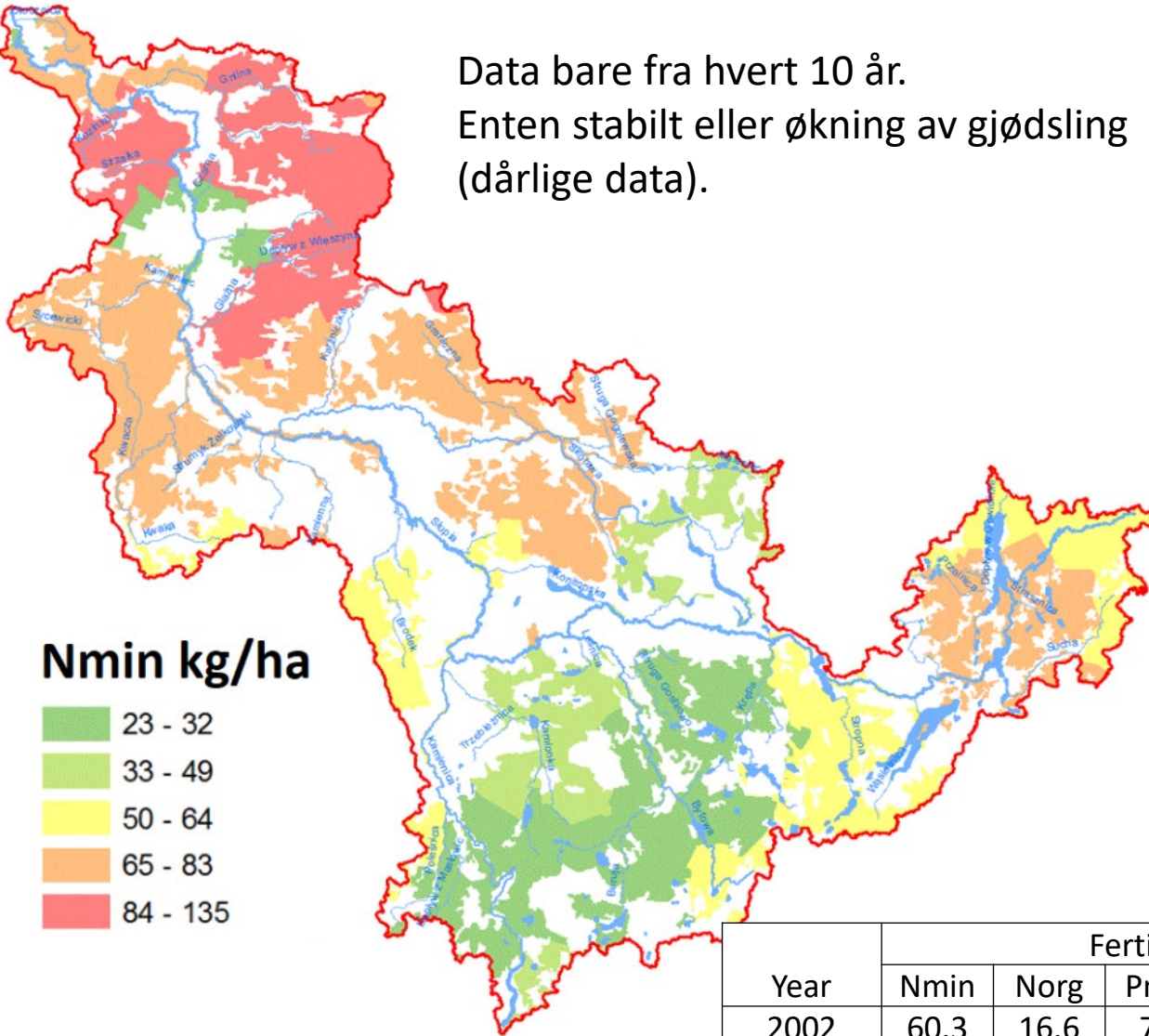
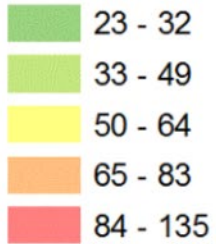

Charnowo monitoring point

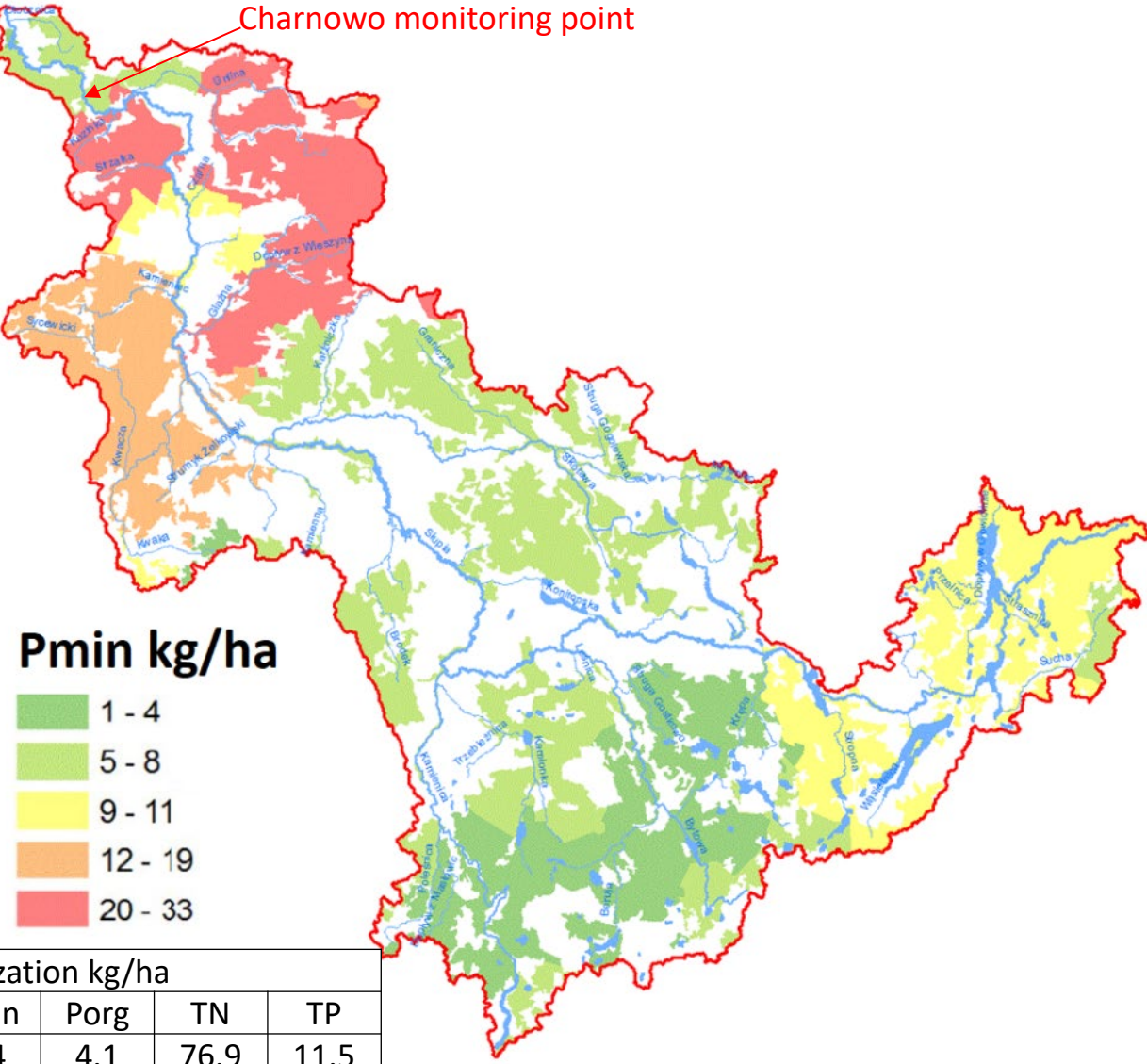

Pmin kg/ha



Year	Fertilization kg/ha					
	Nmin	Norg	Pmin	Porg	TN	TP
2002	60.3	16.6	7.4	4.1	76.9	11.5
2010	68.6	18.0	5.4	4.4	86.6	9.8
2020	64.3	18.6	8.1	4.4	82.9	12.5

Source: Polish Statistical Office 2010

Og her hjemme...

Eutrofiutvikling i norske innsjøer

Anne Lyche Solheim, NIVA

NIVAs prosjektteam:

Sigrid Haande, Jonas Persson, Benno Dillinger,
Birger Skjelbred, Marit Mjelde

Oppdrag for Miljødirektoratet v Helga Gunnarsdottir

Nasjonalt oversikt: Trender

- Kun 1/3 av innsjøene har nok data for trendanalyser (data fra minst 4 år)
- Trendanalyse ikke mulig for andre parametere enn klorofyll og Tot-P
- Ingen trend funnet for > 70% av innsjøene med nok data (126 totalt)
- Tot-P: Stigende trend i 15 sjøer (12%), avtagende trend i 18 sjøer (14%)
- Klorofyll: Stigende trend i 12 sjøer (10%), avtagende trend i 26 sjøer (21%)

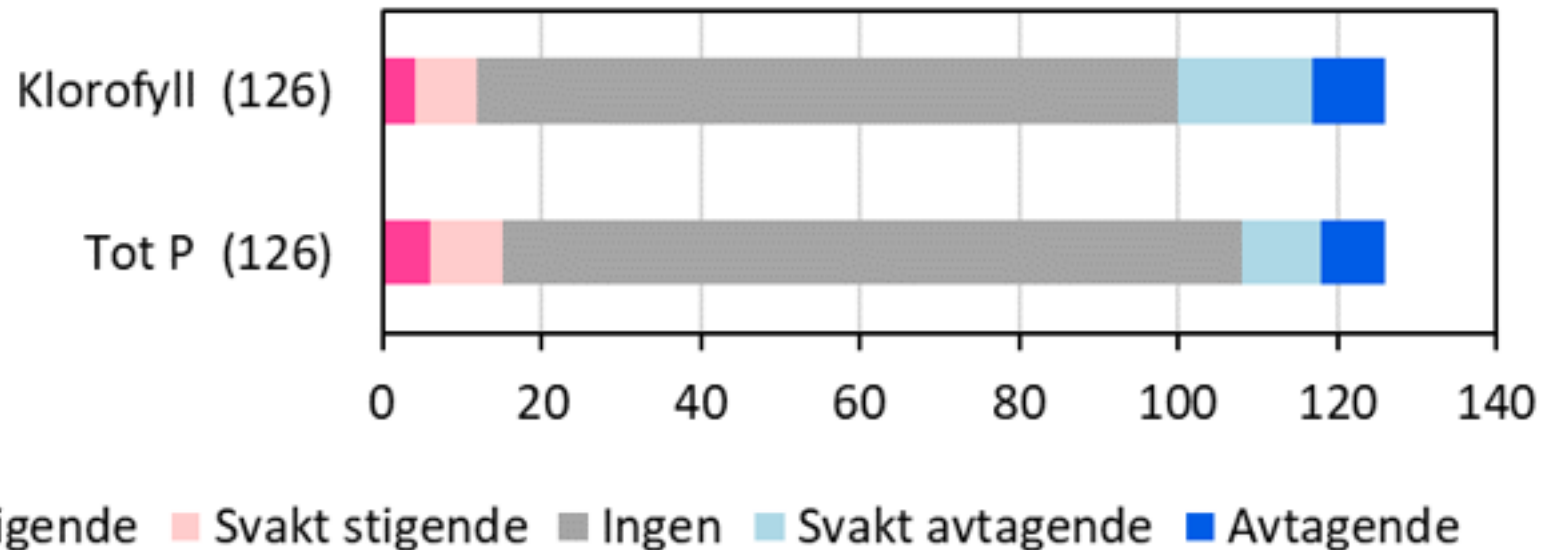

Tilstand og trender Innlandet/Viken

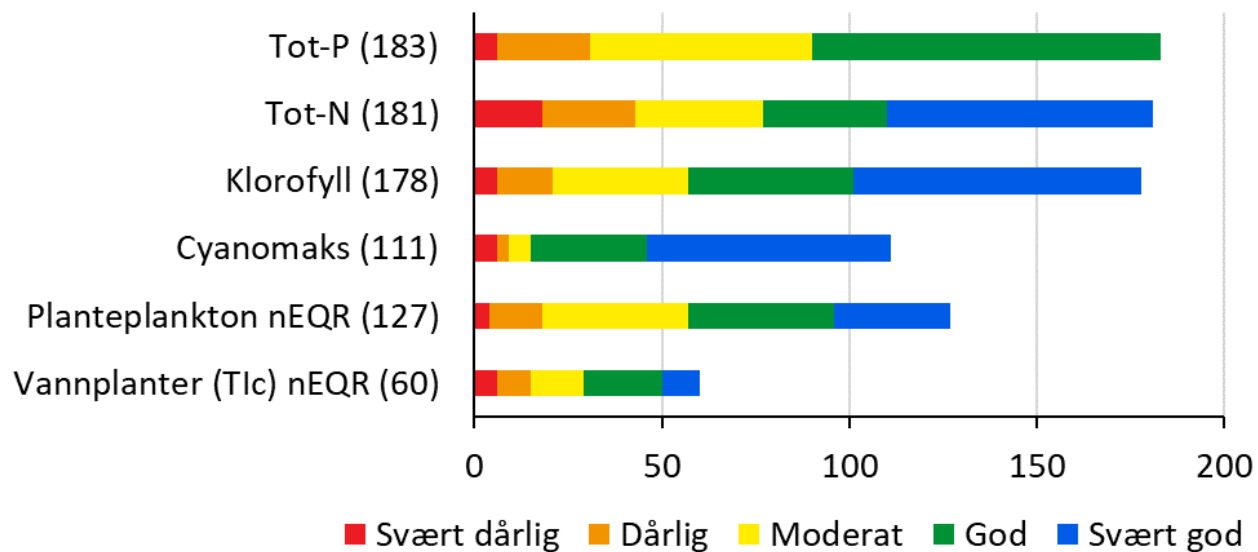

Vannområder med mange eutrofierte innsjøer:

- Bunnefjorden m Årungen og Gjersjøvassdr. (PURA)
- Eikeren vannområde
- Glomma Sør
- Haldenvassdraget
- Indre Oslofjord Vest
- Morsa
- Randsfjorden vannområde

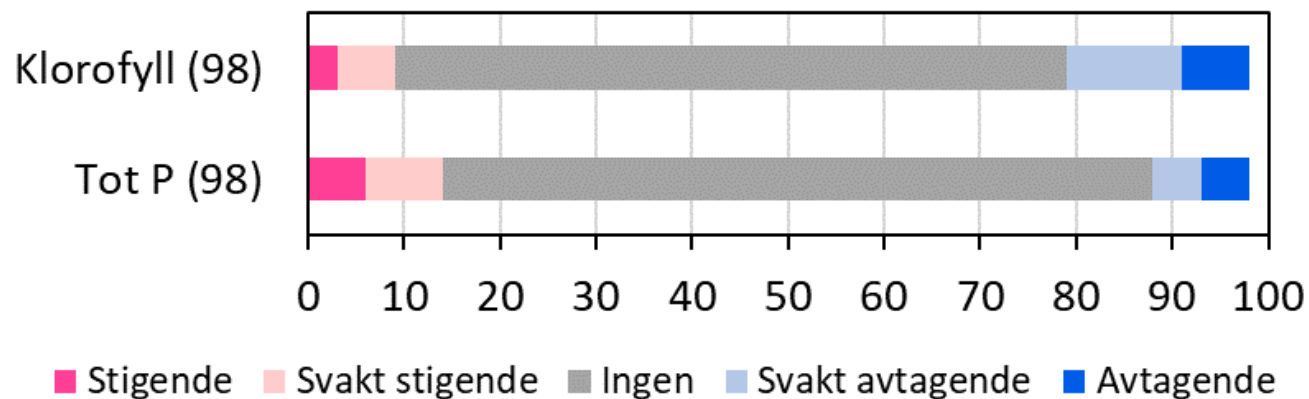

Vannområder med størst forbedring (blå trender):

- Morsa

Vannområder med størst forverring (rosa trender):

- Randsfjorden vannområde

Innlandet og Viken: Eksempler på trender

Bjørkelangen i Haldenvassdraget:

Klorofyll

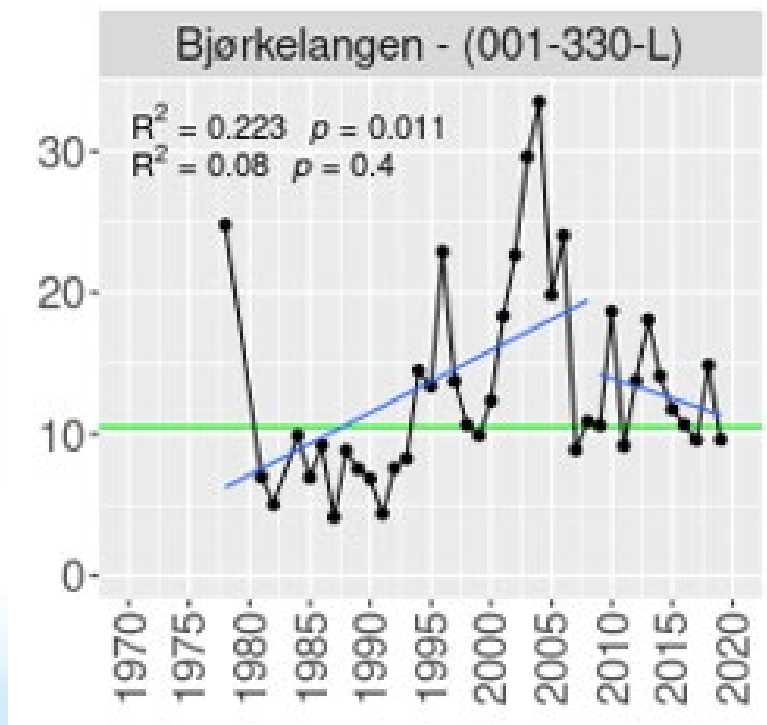

Tot-P

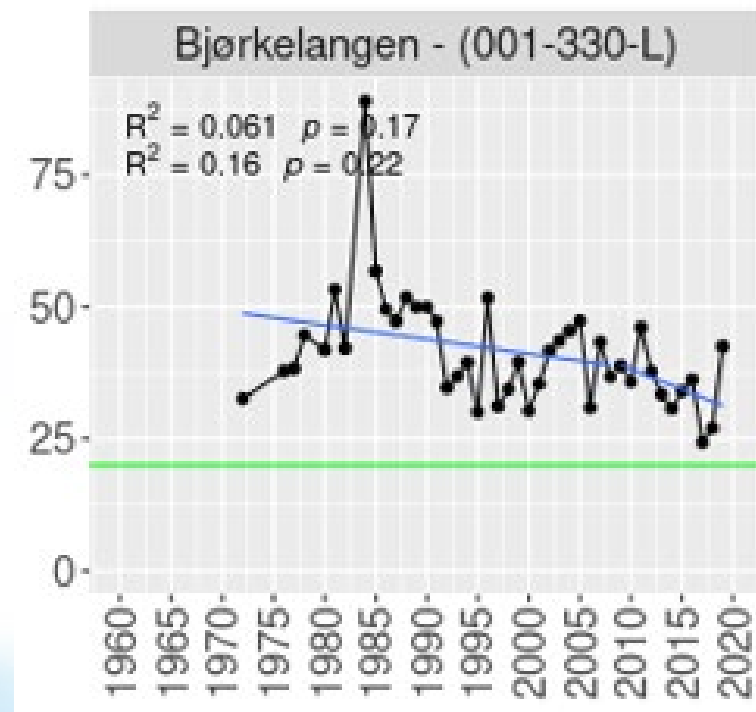

Innlandet og Viken: Eksempler på trender

Kolbotnvannet i PURA:

Klorofyll

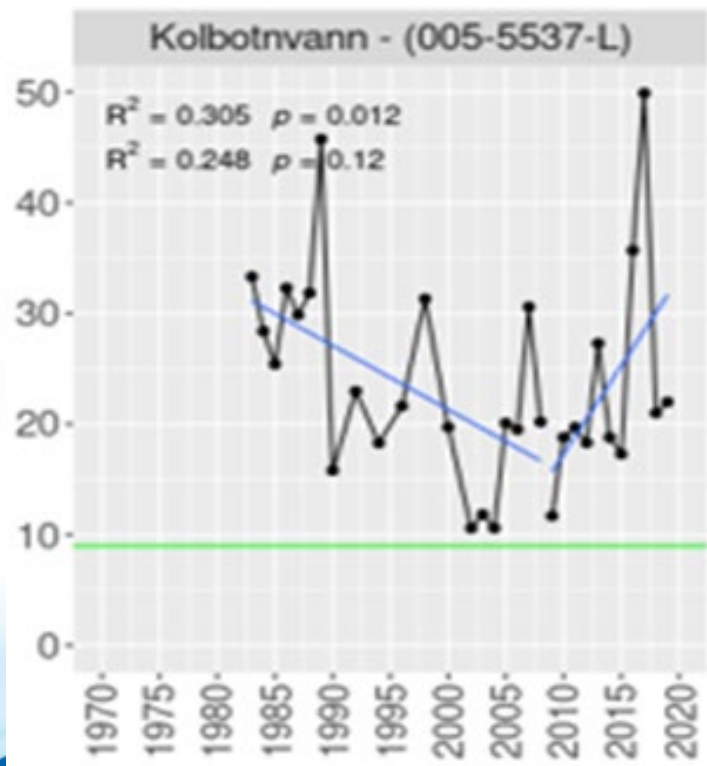

Tot-P

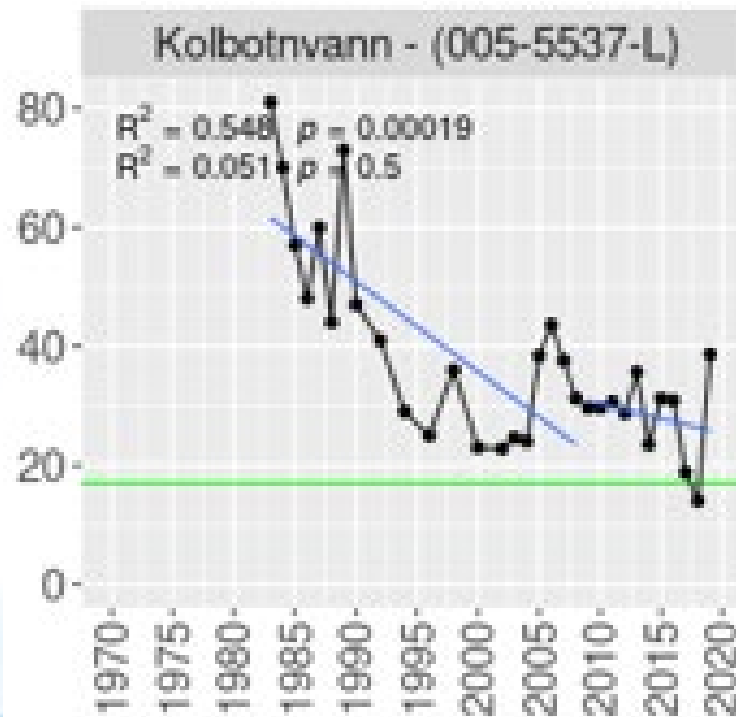

Norge: Morsa –Hobølelva

Signifikant nedgang i TP* tilførsler og konsentrasjoner i Hobølelva.

Og som vi vet – mange tiltak...

Redusert jordarbeiding, mindre bruk av P-gjødsel, vegeterte kantsoner, fangdammer, grasdekte vannveier osv.

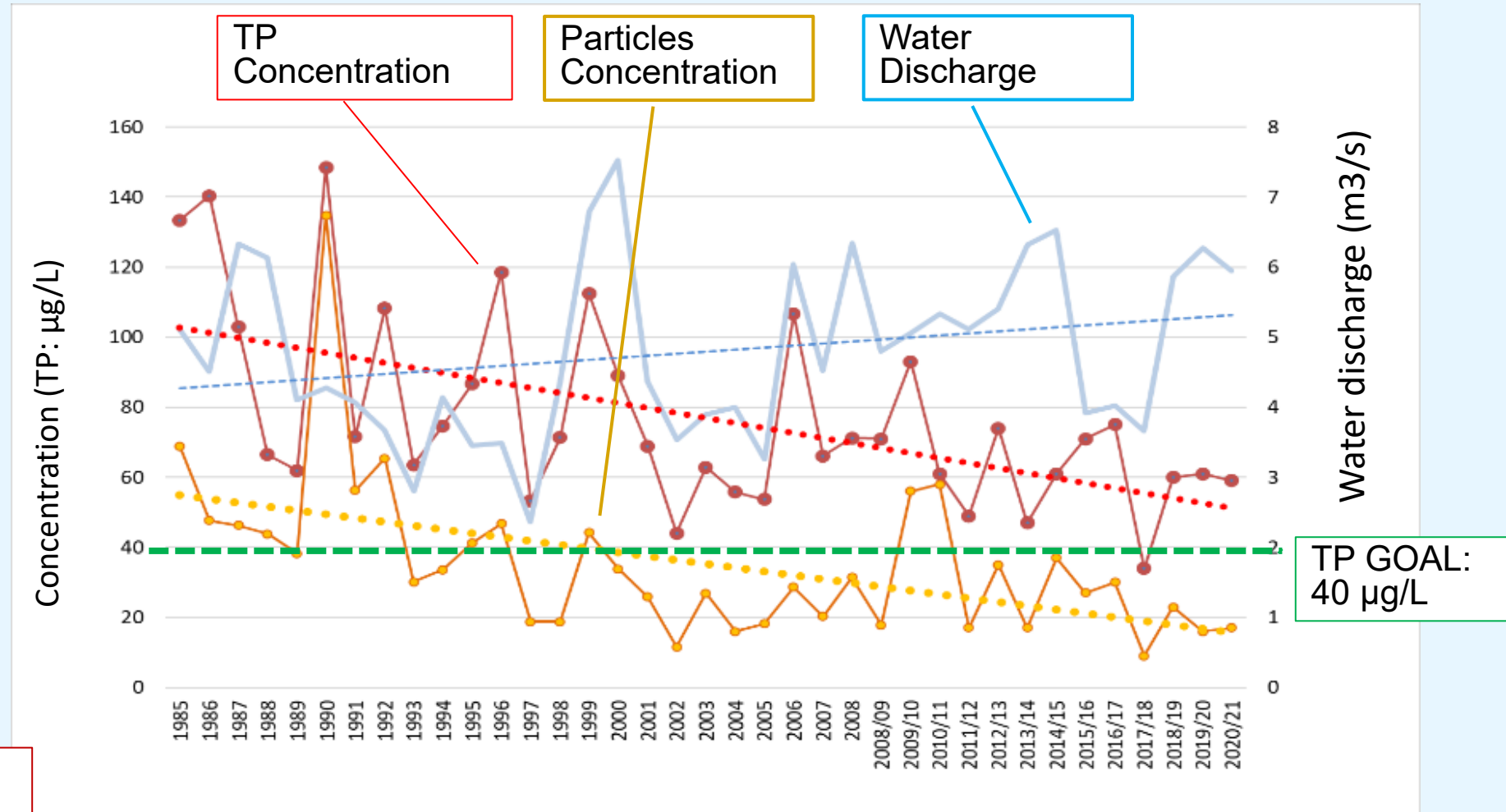

*TP=Total Phosphorus

Norge og Morsa: Eksempel, miljøbasert jordarbeiding

2009: 60-40-regelen

2013: 60-40 regelen fjernet, redusert tilskudd for å ikke pløye om høsten

2023: Ny regulering...

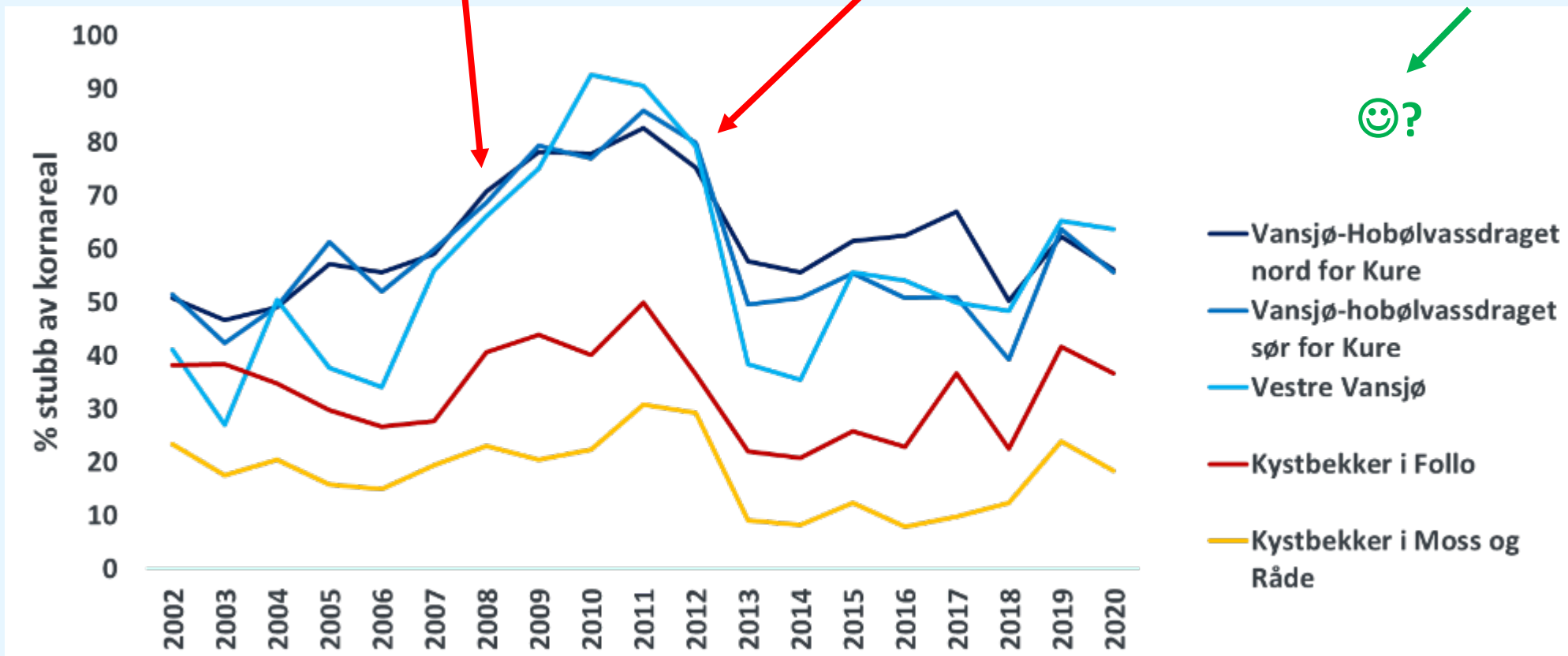

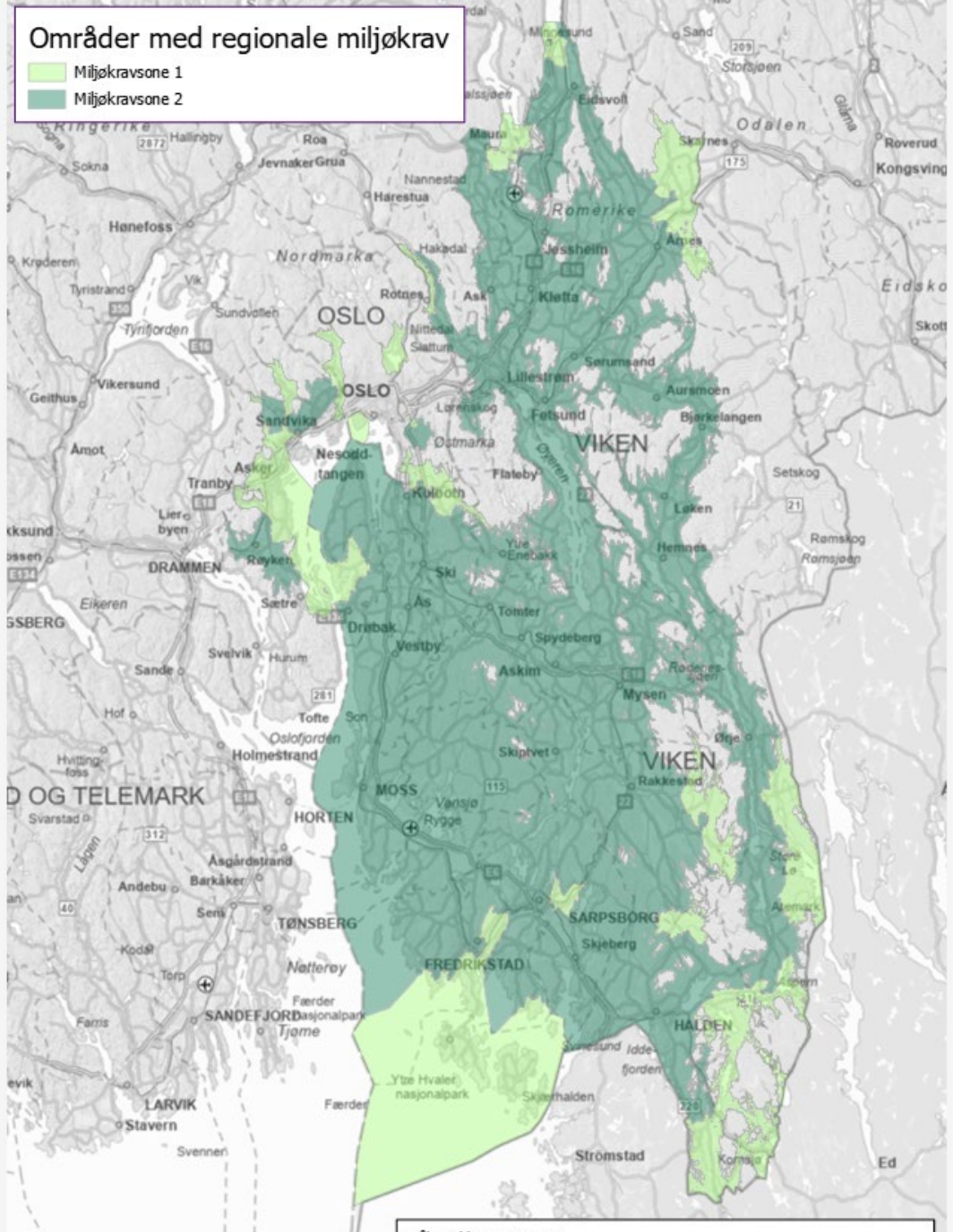

Miljøkravzone 2 (mørk grønn farge i kartet)

1. Det skal ikke jordarbeides nærmere enn to meter fra nedløpskummer for overflatevann og grøfteutløp.

2. Erosjonsutsatte dråg skal ikke jordarbeides om høsten. Ved jordarbeiding på arealet som drenerer til/heller mot dråget, skal drågene ha minst 6 meter permanent grasdekke.

Lys grønn sone: Ved lett høstharving er det tilstrekkelig med minst 6 meter stubb i dråget.

3. Det skal være buffersone langs alle vassdrag som mottar avrenning fra fulldyrka jord.

4. Flomutsatte arealer skal ikke jordarbeides om høsten. På flomutsatte arealer der flom medfører erosjon skal det være 6 meter varig vegetasjon i tillegg til 2 meter vegetasjonssone.

Miljøkravsone 2 (mørk grønn farge i kartet)

5. Fulldyrka mark med stor eller svært stor erosjonsrisiko (erosjonsrisikoklasse 3 og 4) skal ikke jordarbeides om høsten. Lett høstharving til høstkorn eller høstoljevekster tillates likevel på arealer som ikke er omfattet av miljøkrav 2, 3 og 4. For å sikre god etablering av høstvekster må de sås senest innen 20. september.

6. Minst 60 % av foretakets fulldyrkede areal skal overvintre med plantedekke tilsvarende stubb, gras, direktesådd fangvekst eller direktesådd høstkorn. Lett høstharving tillates likevel til høstkorn eller høstoljevekster. For å sikre god etablering av høstvekster må de sås senest innen 20. september. Arealer som båndlegges av krav 2, 3, 4 og 5 inngår i 60 % av foretakets fulldyrkede areal.

Gjelder ikke i
lys grønn sone.

Oppsummert...

- › **Der det har vært langvarig fokus på miljøtiltak ser vi resultater**
- › **Enkelte steder, hvor det IKKE har vært SPESIELT fokus på miljøtiltak, kan vi heller ikke forvente å finne trender.**

Så da lurer vi på hva dere tror om...

- › Gulrot og/eller pisk: Trenger vi flere økonomiske og/eller juridiske virkemidler?
- › Hva tror du blir effekten av den nye forskriften om regionale miljøkrav i Oslo/Viken?

Bør dagens miljømål (G/M-grensa) for Tot-P og Tot-N gjøres strengere?

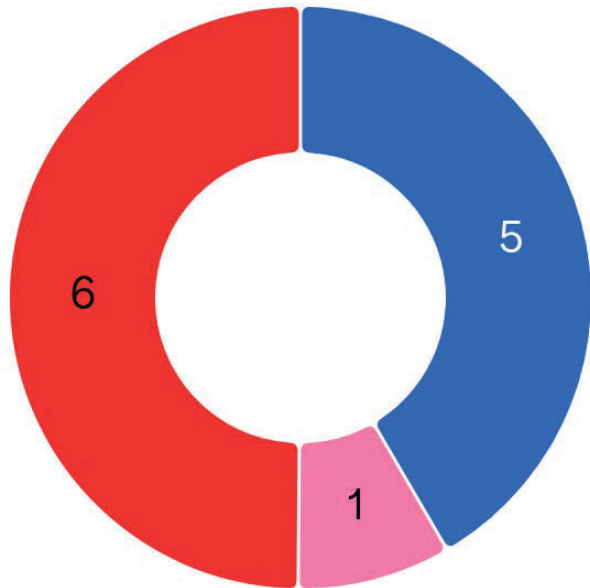

- 5 Ja, fordi miljømålene må sikre god økologisk tilstand
- 1 Nei, fordi de er vanskelige nok å oppfylle i dag
- 6 Det bør utføres mer overvåking og analyser før det konkluderes

Bør miljømål for næringsstoff endres fordi klimaendringer påvirker økologisk tilstand?

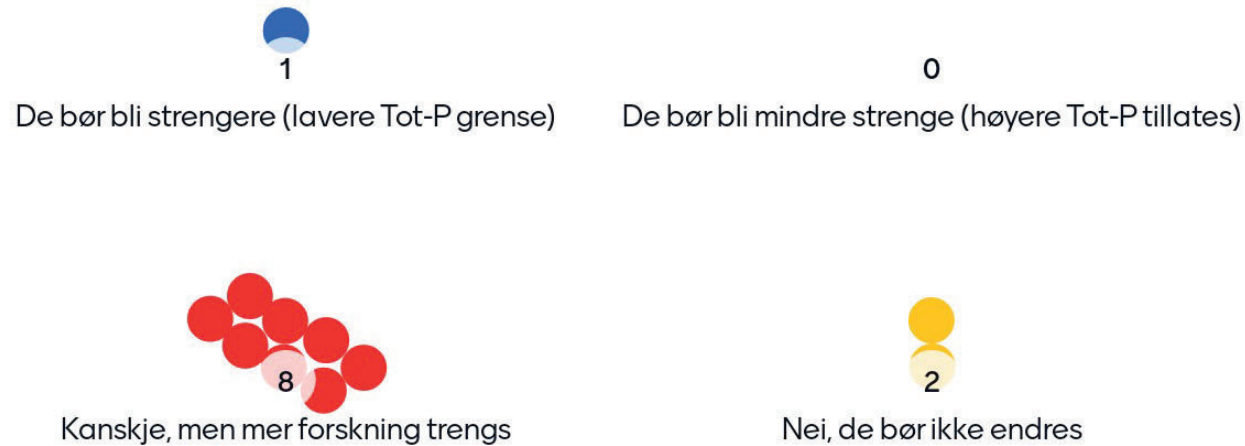

Hvis vi skal modellere vannmengde, hva er du mest interessert i? (RANGER!)

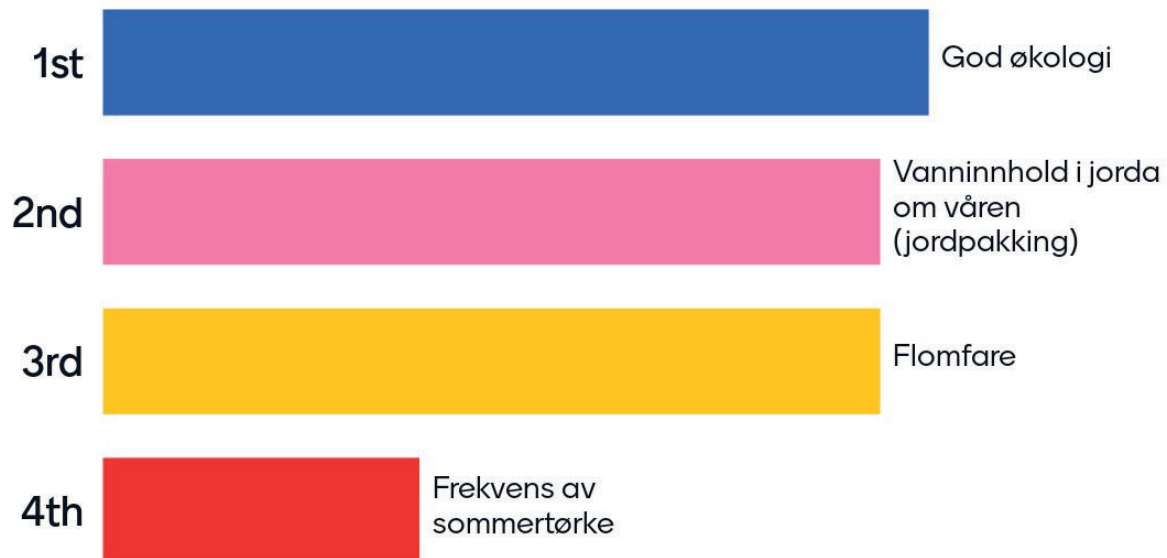

Hva vil du helst vi modellerer innen vannkvalitet? (RANGER!)

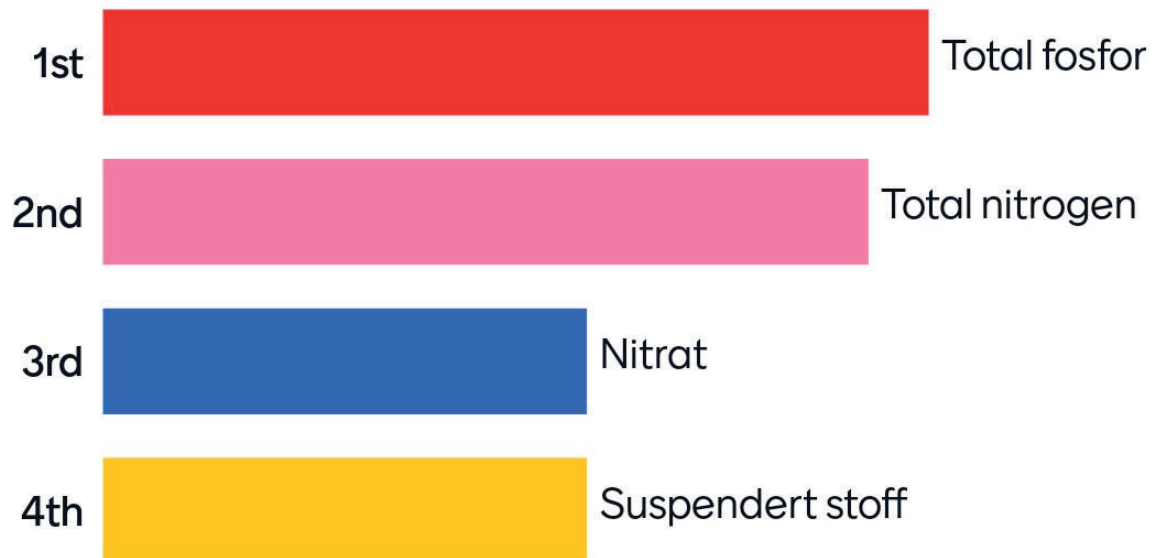

Hva er mest interessant: Tap (tilførsler) eller konsentrasjon? (eller begge)



- Konsentrasjon
 - Tap (tilførsler)
-

Hvilke tiltak vil du helst få modellert effekten av?

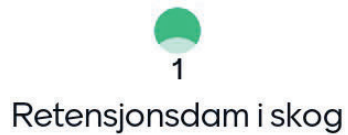

Hvor stor usikkerhet vil du godta for stikkprøver?

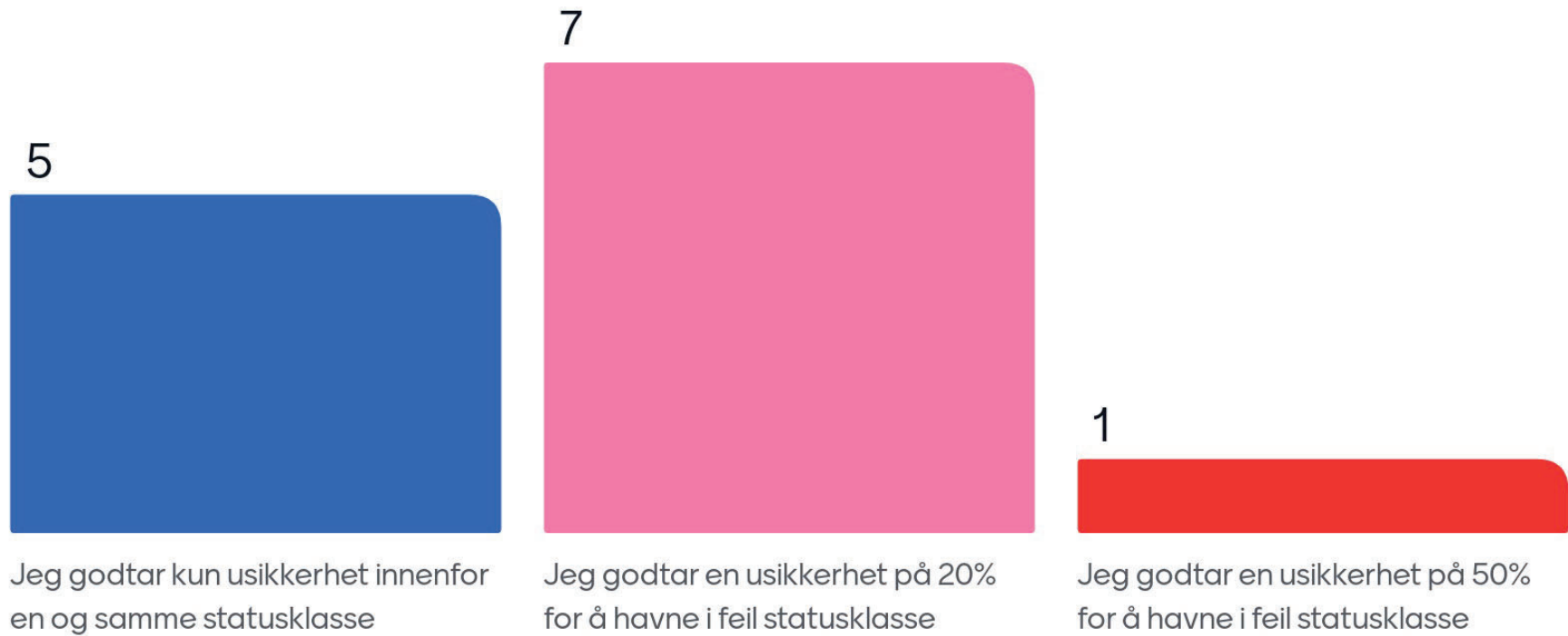

Har du vært inne på nettsidene og sett på grafene?

1
Ja, ukentlig

2
Ja, månedlig

2
Ja, én gang

9
Nei, aldri

Hvem kan ha nytte av slike sanntidsdata?

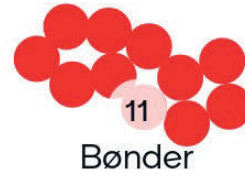

Andre

Virkemidler: Gulrot eller pisk?

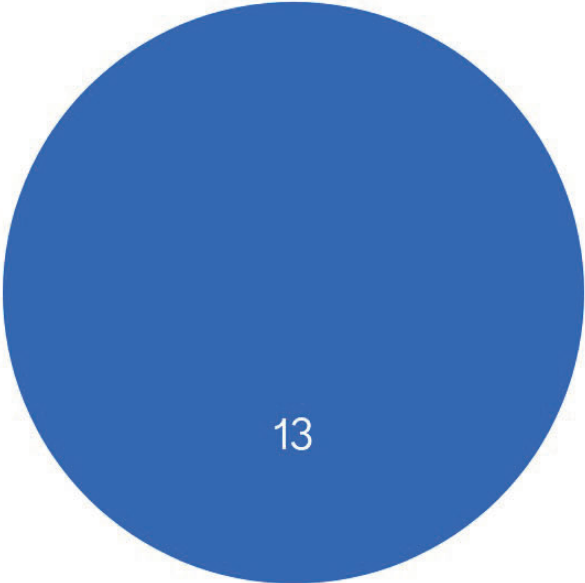

- 13 Vi trenger regionale forskrifter
- 0 Økonomiske virkemidler er tilstrekkelig

Hva tror du blir effekten av den nye forskriften om regionale miljøkrav i Oslo/Viken?



Hva synes du vi skal forske mer på ? (du kan også stemme på 5 andre forslag)

Uttesting av rens tiltak for vann fra grøfter og dreneringssystem

7 Popular

Se på effekten av fosforstatus i jord.

5

Klimatilpasningstiltak i jordbruket. Hvordan dette er ivare tatt i planer som f.eks. NLR utfører for grunneiere

5

Effektive agronomiske tiltak for å redusere nitrogentap.

4

Hvor mye næringsstoffer som tilføres jordbruksarealene og hvor mye som høstes (avlingsnivå og næringsstoffinnhold)

4

1) Realismen i å nå miljømålene med de klassegrensene vi nå har2) Fosforindeks-håndboka må frem fra glemselen3) Videre jobbing med modeller for å få de mer og mer pålitelige

3

Se på ulike tiltak for å redusere N

3

Resultater/effekter av regionale miljøkrav, både mht eutrofi og matproduksjon.

3

1



8



Hva synes du vi skal forske mer på ? (du kan også stemme på 5 andre forslag)

Miljøeffekt av regenerative prinsipper. Overvintrende fagvekster i et 0-jordarbeidingssystem.
Miljøeffekter av grøf팅.

3

Eggekt av ulike rensetiltak og buffersoner rundt kummer

1

Effekt av «toppgjødsling» for å oppnå noen prosent bedre avling

Kompenserende tiltak som ikke er utbredt bruk, utover de kjente redusert jordarbeiding og gresstiltak.





Örsundaåns avrinningsområde – temadag om extremväder och vattenkvalitet

Tid: Torsdagen den 5:e december kl 9:30 – 15:00, kaffe från 9:00

Plats: Gamla kyrkskolan, Nysätra, Örsundsbro

Extremväder har blivit mer förekommande med översvämningar och torka vilket påverkar vattenkvalitet, odling och samhällets infrastrukturer. För att dela erfarenheter om hur extremväder påverkar miljön och för att diskutera hur vi kan integrera behov av förbättrad vattenkvalitet med hög biodiversitet och hållbar livsmedelsproduktion bjuder vi här in till en temadag.

Upplägget är korta presentationer under förmiddagspasset följt av diskussioner efter lunch.

Program

- 9:00 Kaffe och smörgås
- 9:30 Introduktion och presentationsrunda
- 10:00 Referensvärden och mål för vattenkvalitet
 - är de rimliga och går de att uppnå med mer varierande väder (Jens Fölster)
 - Sensorer för realtidsvisning online eller enkla teststickor
 - metoder som kompletterar varandra (Jens Fölster och Martyn Futter)
 - Växthusgaser och näringsförluster
 - vad händer vid extremväder (Martyn Futter)
 - Modellberäkningar för att skatta näringstransporter
 - kan de användas för att bedöma effekter av extremväder (Kristina Mårtensson)
 - Åtgärder för minskat näringsläckage
 - hur påverkas effektiviteten vid extremväder (Katarina Kyllmar)
 - Regler, stöd och rådgivning
 - räcker nuvarande styrmedel för att dämpa effekter av extremväder (Katarina Kyllmar)
- 12:00 Lunch
- 13:00 Presentationer från Örsundaån
 - Staffan Lund mfl.
 - Workshop (Staffan lund och Katarina Kyllmar)
- 14:30 Kaffe och summering
- 15:00 Mötet avslutas

Hoppas att du har möjlighet att delta!

Anmälan och meddelande om eventuella behov av specialkost önskas senast tisdag 26 november.

Kontakt och anmälan

Katarina Kyllmar, SLU, Institutionen för mark och miljö,
018-67 25 97, katarina.kyllmar@slu.se

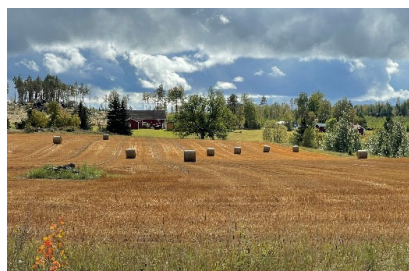

Photo's from 2nd regional stakeholder meeting in Sweden

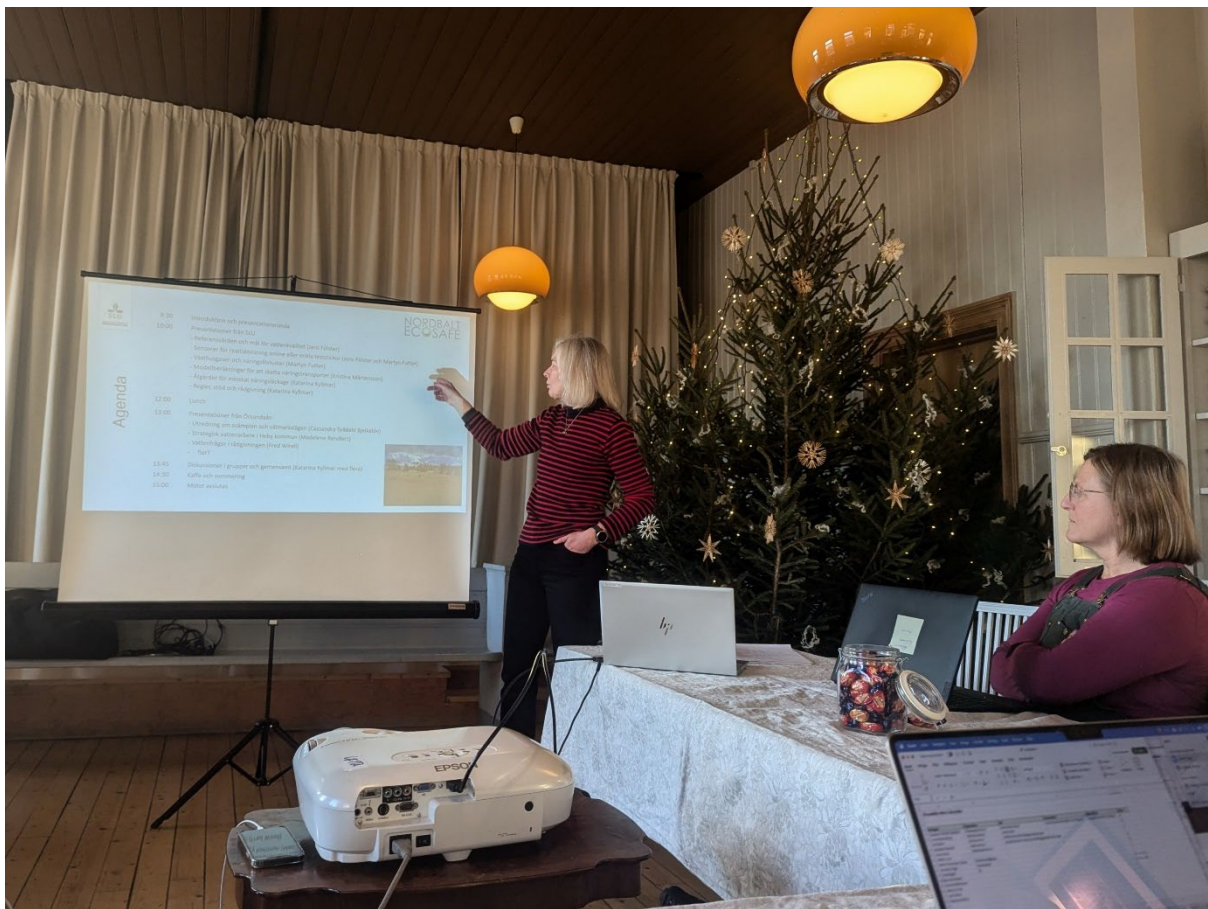





NORDBALT
ECOSAFE



Funded by the
European Union

ÖRSUNDAÅNS AVRINNINGSSOMRÅDE – temadag om extremväder och vattenkvalitet

<https://projects.au.dk/nordbalt-ecosafe>

Syfte med dagen

- Dela kunskap och erfarenheter
- Utforska framtidsfrågorna
- Diskussion om vad som behövs för att skapa hållbarhet i ett förändrat klimat men också i ett mer osäkert omvärldsläge

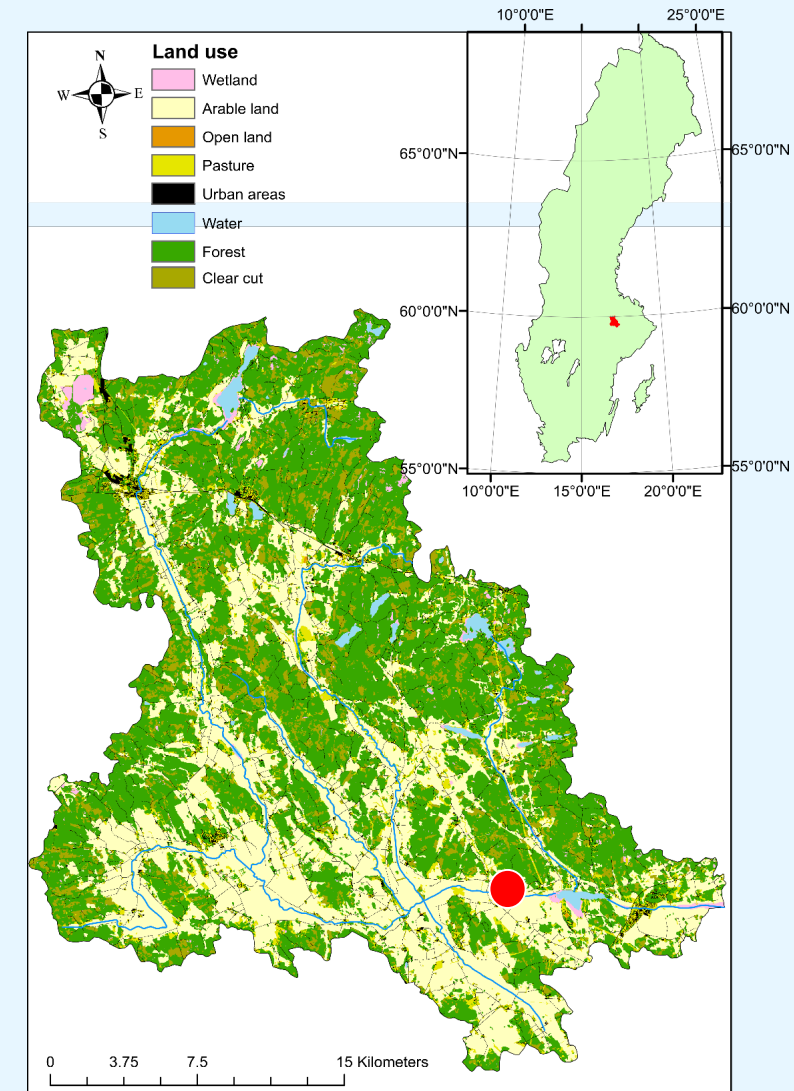

- 9:30 Introduktion och presentationsrunda
- 10:00 Presentationer från SLU
- Referensvärden och mål för vattenkvalitet (Jens Fölster)
 - Sensorer för realtidsvisning online eller enkla teststickor (Jens Fölster och Martyn Futter)
 - Växthusgaser och näringsförluster (Martyn Futter)
 - Modellberäkningar för att skatta näringstransporter (Kristina Mårtensson)
 - Åtgärder för minskat näringsläckage (Katarina Kyllmar)
 - Regler, stöd och rådgivning (Katarina Kyllmar)
- 12:00 Lunch
- 13:00 Presentationer från Örsundaån
- Utredning om svämplan och våtmarkslägen (Cassandra Telldahl Bjelkelöv)
 - Strategisk vattenarbete i Heby kommun (Madelene Rendlert)
 - Vattenfrågor i rådgivningen (Fred Wirell)
 - fler?
- 13:45 Diskussioner i grupper och gemensamt (Katarina Kyllmar med flera)
- 14:30 Kaffe och summering
- 15:00 Mötet avslutas



Diskussionsfrågor

1. Vilka är framtidsfrågorna?
2. Vad är viktigt för min 'organisation'?
3. Vad behövs för att detta ska hända?

Tre grupper – fördela er mellan organisationerna

Skriv ner era resonemang på A3-blad

Sammanfattning i helgrupp

Sammanfattning av diskussioner

Vilka är framtidsfrågorna?

nnnn

Sammanfattning av diskussioner

Vad är viktigt för min organisation?

nnnn

Sammanfattning av diskussioner

Vad behövs för att detta ska hända?

nnnn



Funded by the
European Union

REFERENSVÄRDEN OCH MÅL FÖR VATTENKVALITET

- ÄR DE RIMLIGA OCH GÅR DE ATTUPPNÅ MED MER VARIERANDE VÄDER

<https://projects.au.dk/nordbalt-ecosafe>

I SVERIGE BERÄKNAS ETT REFERENSVÄRDE FÖR FÖR VARJE VATTENFÖREKOMST

Vattendrag

Sjöar



Funded by the
European Union

KLASSGRÄNSERNA ÄR KOPPLADE TILL DEM FÖR KLOROFYLL



Funded by the
European Union

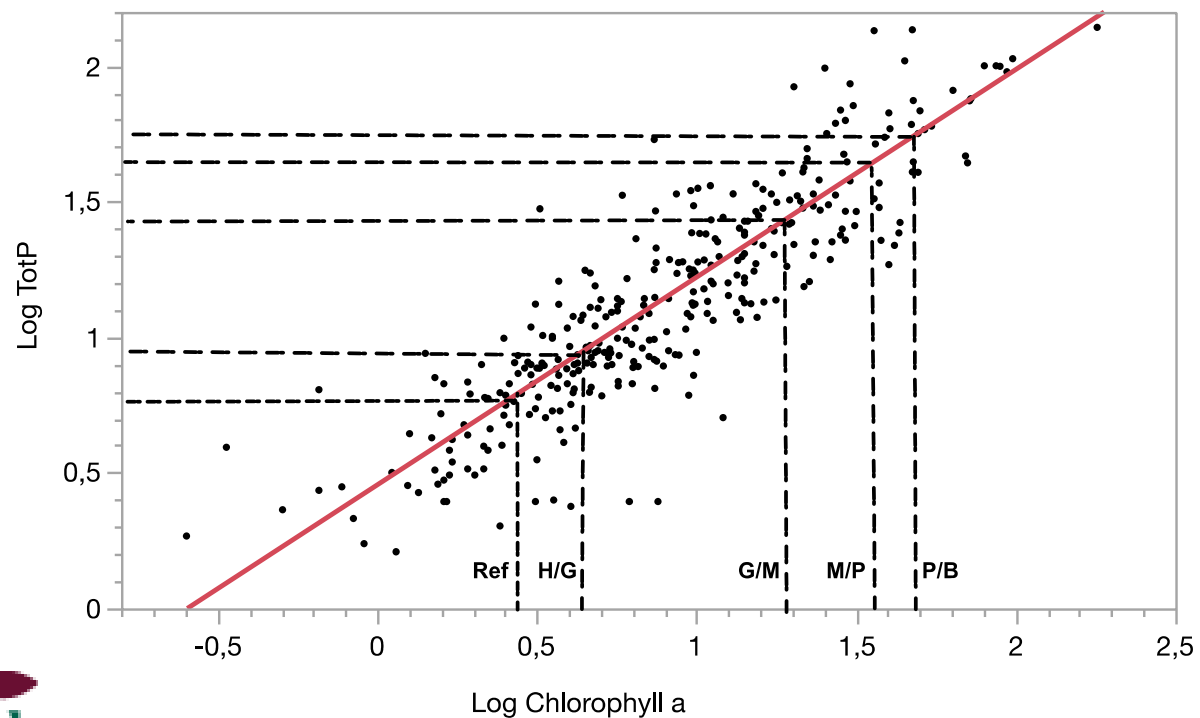

STORA SKILLNADER MELLAN LÄNDER HUR MAN SATT KLASSGRÄNSER FÖR TP-P



Funded by the European Union

Men stora skillnader mellan länderna i G/M gräns

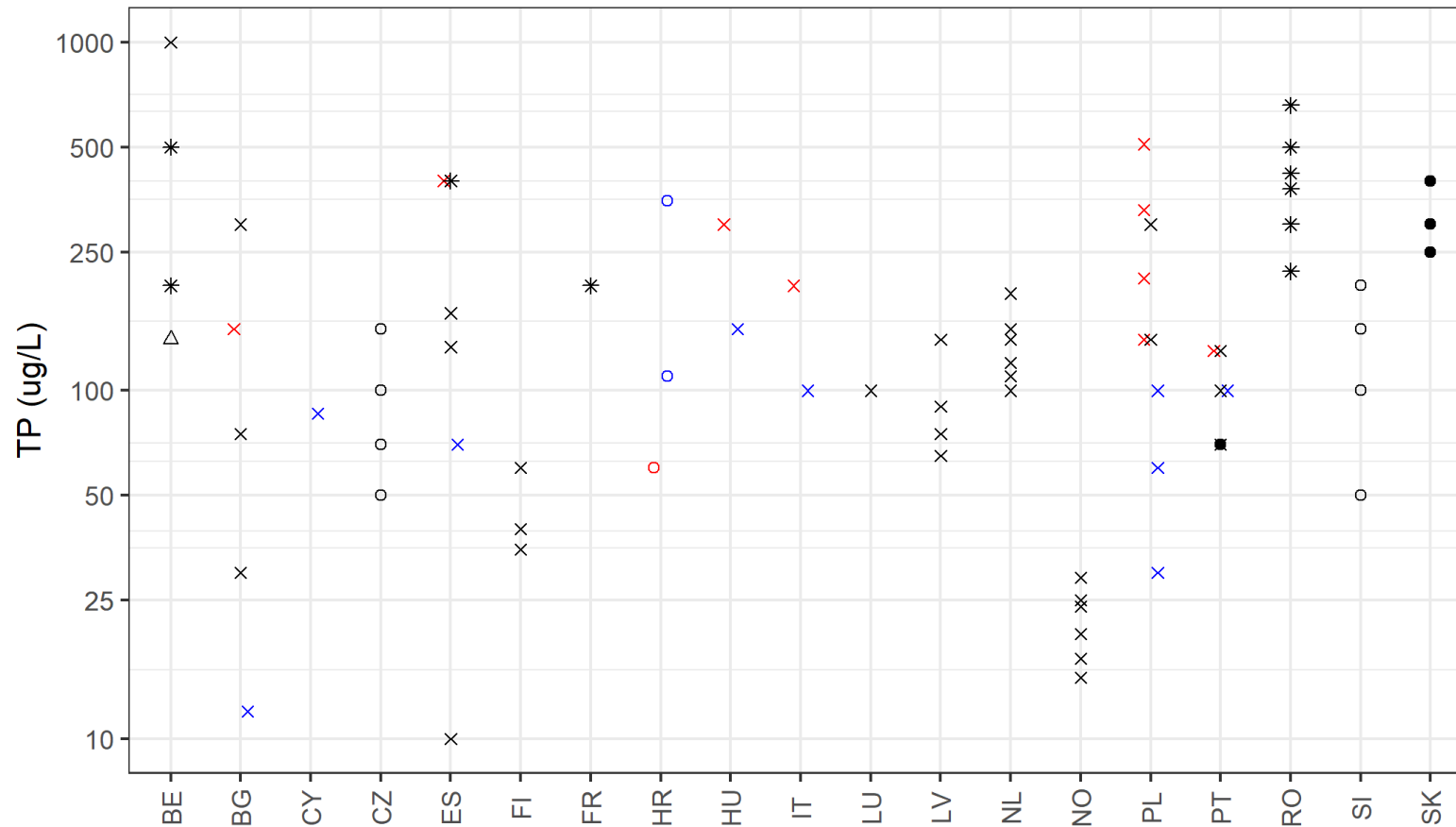

STATISTIKVERKTYG FRÅN ECOSTAT



Funded by the European Union

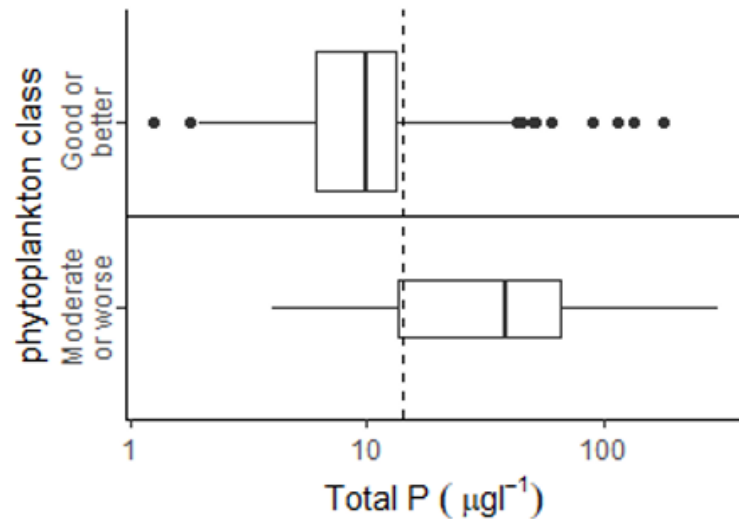
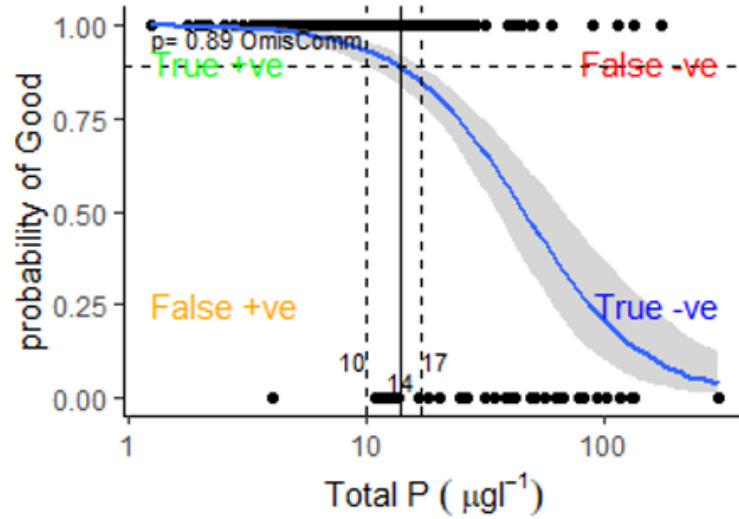

DATASETS FOR COMMON TYPES IN THE NORDBALTECOSAFE PARTNER COUNTRIES:



Funded by the European Union

LAKE PHYTOPLANKTON

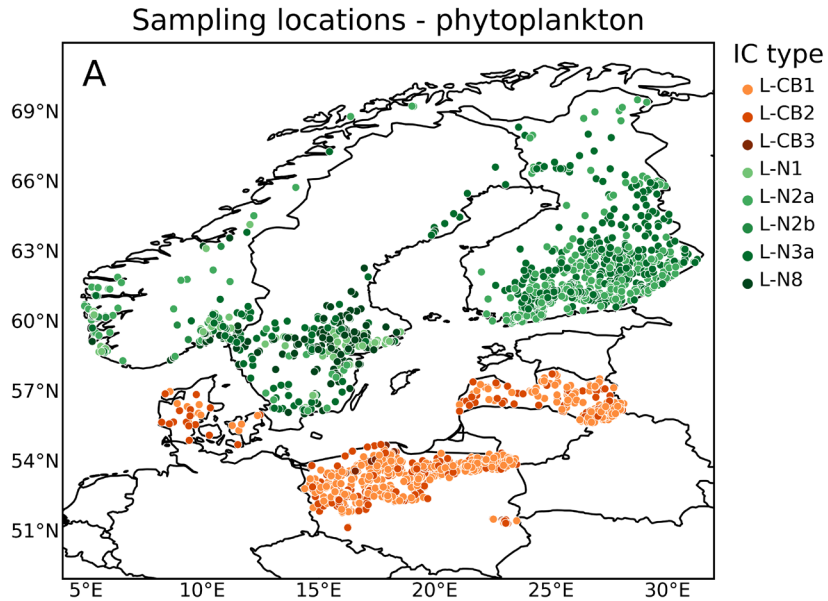

RIVER PHYTOBENTHOS

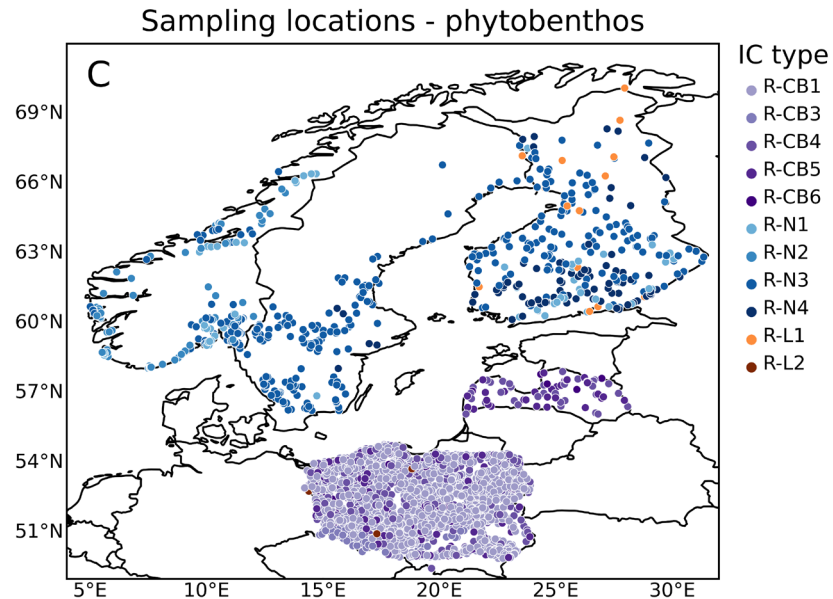

+ annual mean concentrations of total phosphorus and total nitrogen for all water bodies with biology data converted to normalised Ecological quality ratio (nEQR)-values



STATISTIKVERKTYG FRÅN ECOSTAT



Funded by the European Union

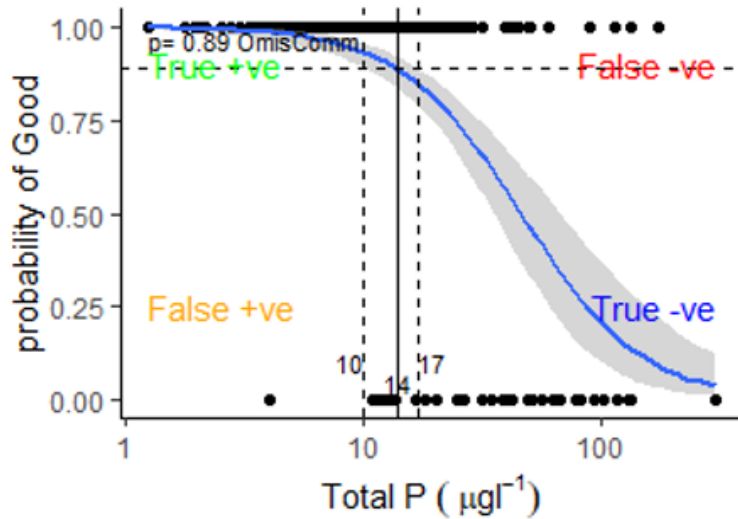

Pågående arbete även i Sverige:

- kan vi ge klassningen av TotP bättre koppling till den biologiska?
- Är det värt besväret att ändra systemet igen?

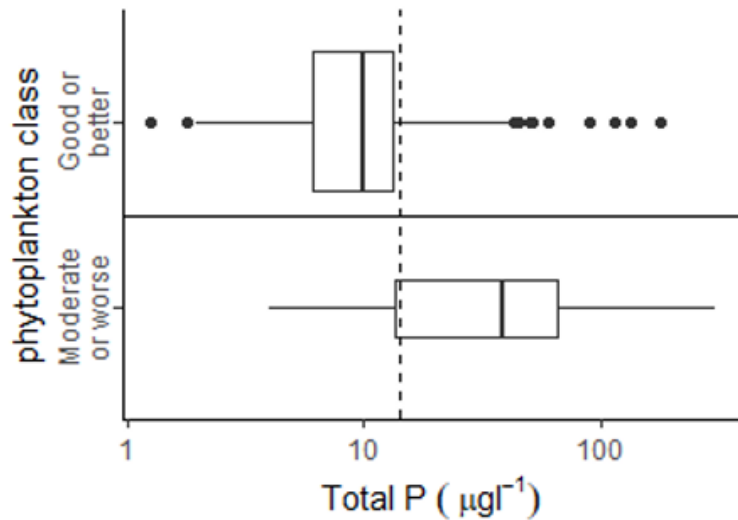

MÅSTE KLASSGRÄNSERNA ÄNDRAS MED ETT FÖRÄNDRAT KLIMAT?



Funded by the
European Union

Ökar känsligheten?

- Högre temperatur
- Lägre syrgashalter

Minskar känsligheten?

- Brunare vatten
- Grumligare vatten
- Ökade högflöden

KLIMATPÅVERKAN PÅ EK-VÄRDEN

EXEMPEL PÅ MODELLERING MED BRUNASJÖAR



Funded by the
European Union

Preliminära resultat indikerar::

- Ökad TotP, nederbörd och temperatur antas försämra den ekologiska statusen för växtplankton
- Klimateffekterna är mindre än om TotP ökar.

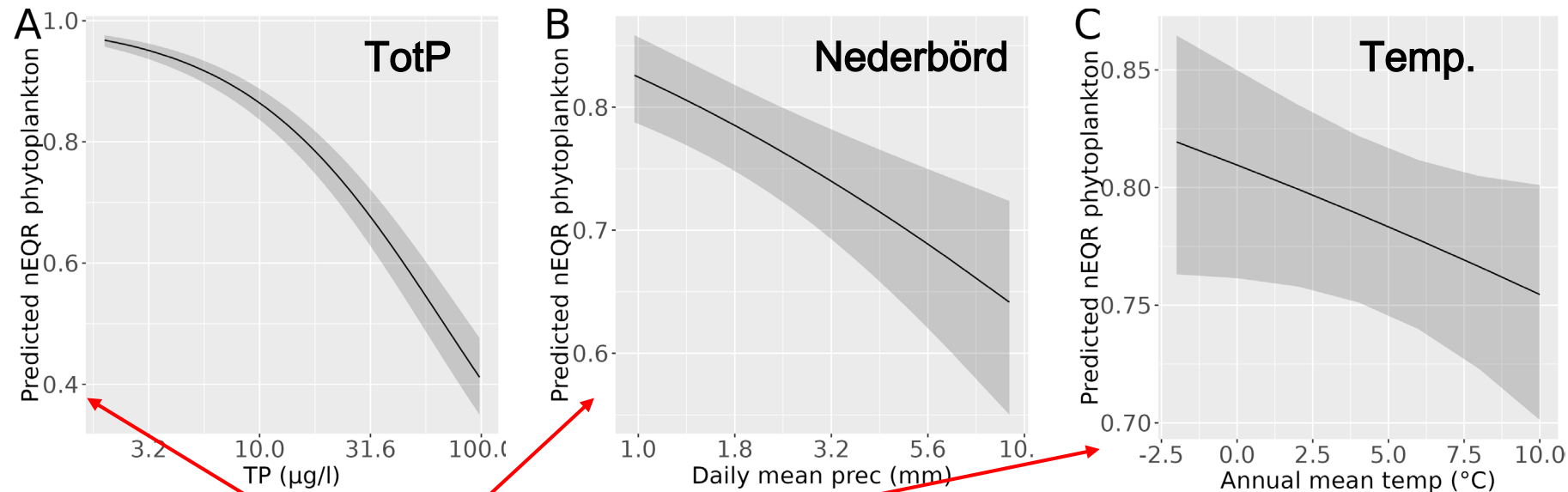

Örsundaån –förenklad modell utan Ca, Mg och SO4

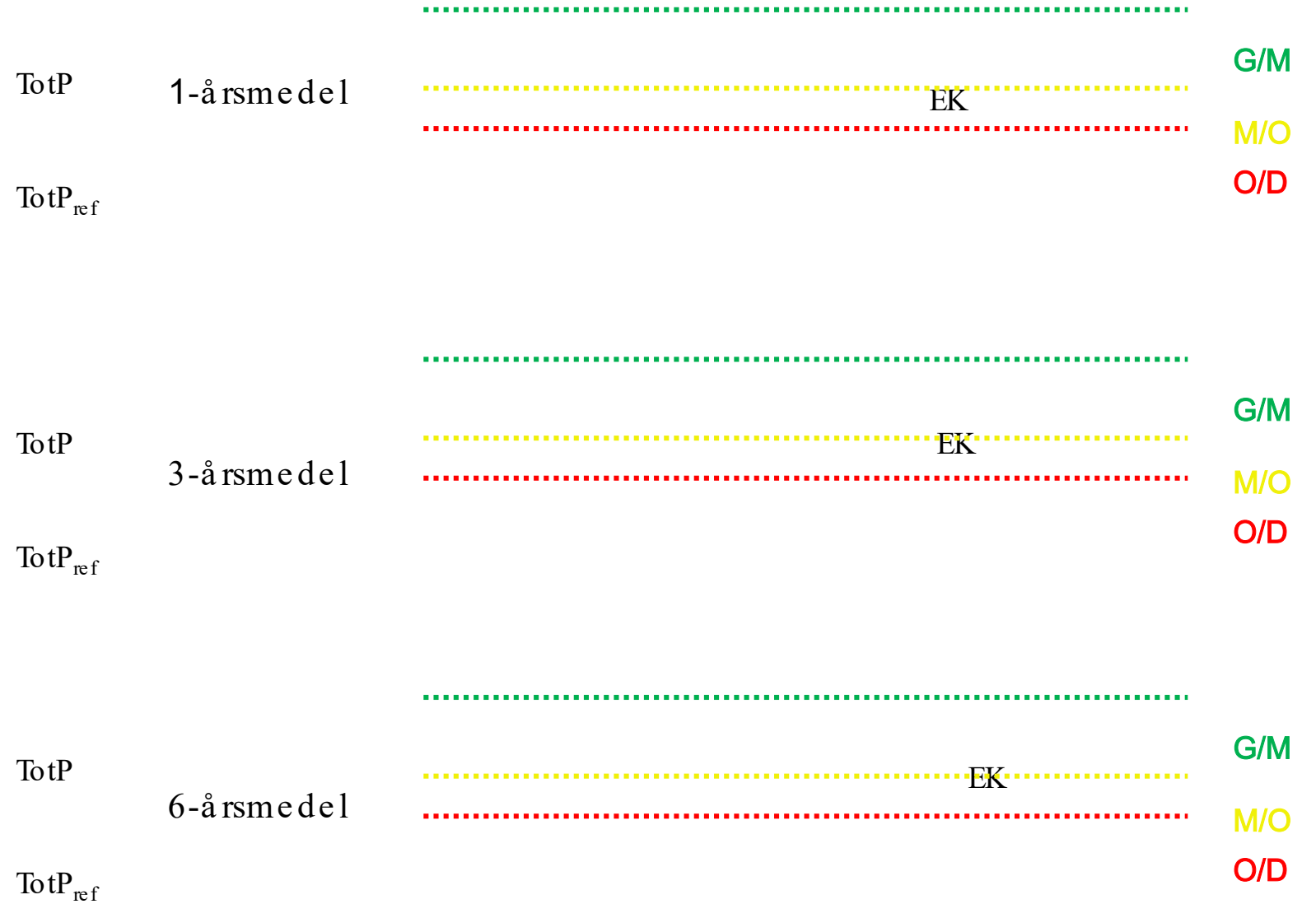

HUR HANTERAR MAN OSÄKERHET I KLASSNINGAR?



Funded by the
European Union



NORDBALT
ECOSAFE

FRÅGOR?



Funded by the
European Union

DISKUSSIONSFRÅGOR



Funded by the
European Union

1. Hur kan man hantera osäkra klassningar i förvaltningen?
2. Är det viktigt att veta hur ofta man måste provta för statusklassningen?
3. Hur viktigt är det att förbättra precisionen i statusklassningen?



Funded by the
European Union

SENSORER FÖR REALTIDSVISNING ON-LINE OCH ENKLA SNABBTEST

METODER SOM KOMPLETTERAR VARANDRA

<https://projects.au.dk/nordbalt-ecosafe>



Funded by the European Union



NORDBALT
ECOSAFE

SENSORER I NORDBALT ECOSAFE



Funded by the European Union

Real-time data from seven Nordic streams, shown on the project website: <https://projects.au.dk/nordbalt-ecosafe>

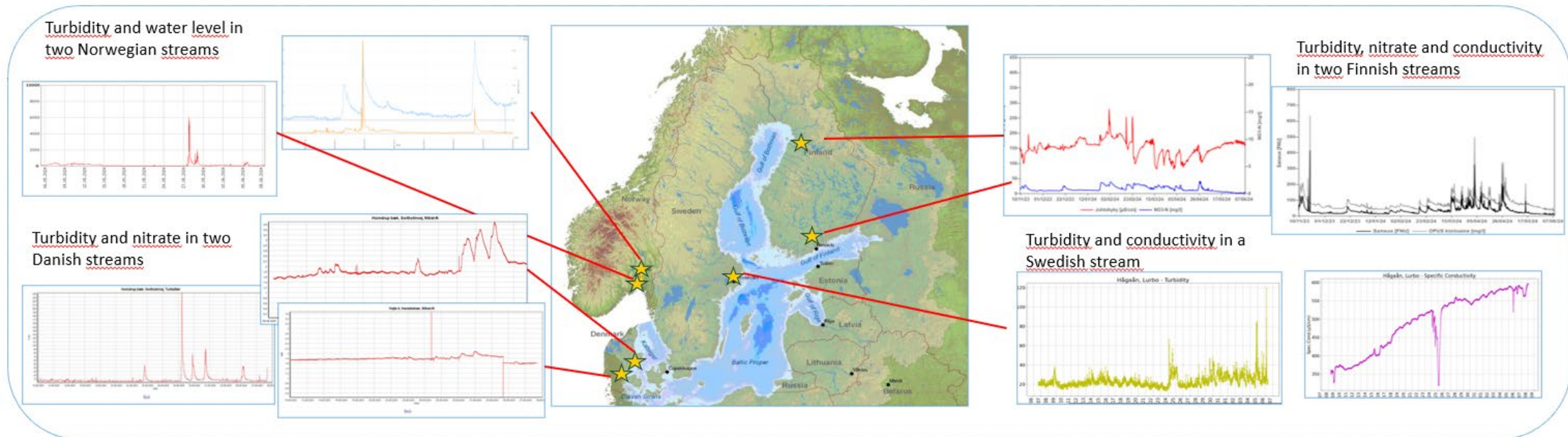

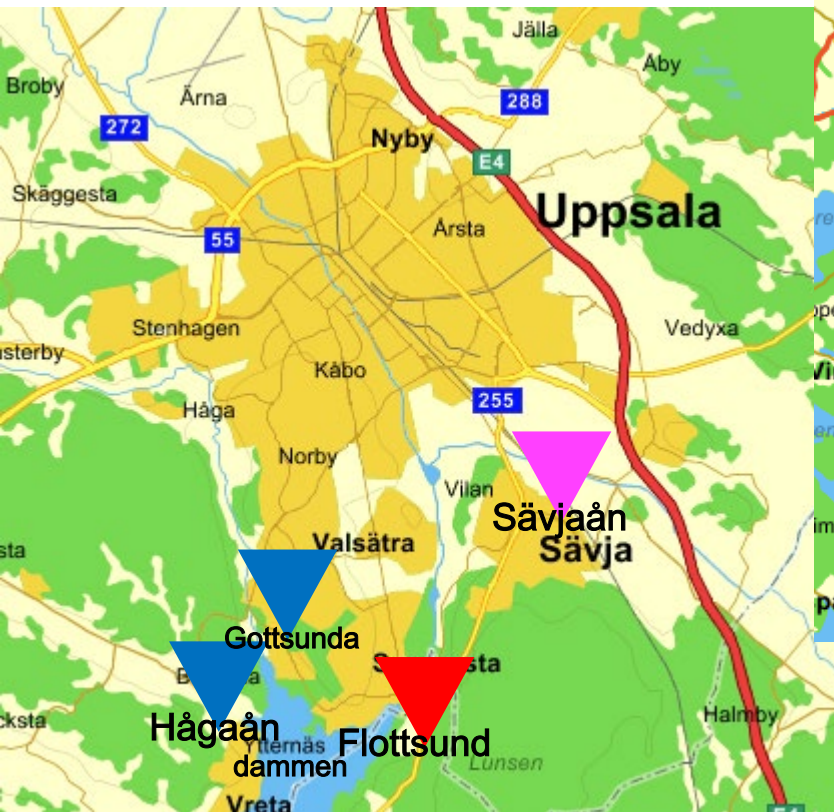

Havs
och Vatten
myndigheten



TURBIDITET SOM PROXY FÖR TOT-P



Funded by the
European Union

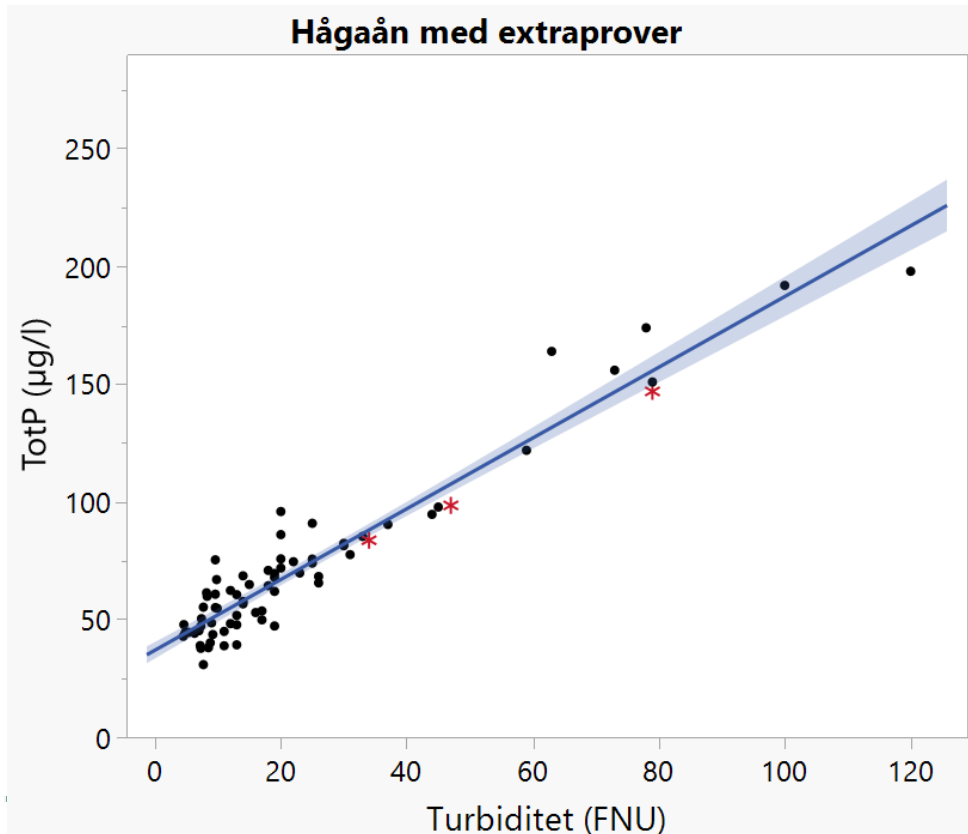

Station	r^2 (%)
Dalälven	88,0
Fyrisån	67,0
Hågaån	92,0
Kilaån	96,0
Sagån	89,1
Skivarpsån	45,5 (66,6 utan outliern)
Sävjaån	73,9 (86,9 utan outliern)

TRANSPORTBERÄKNINGAR



Funded by the
European Union

Med månadsvisa provtagningar
underskattas ofta transporten

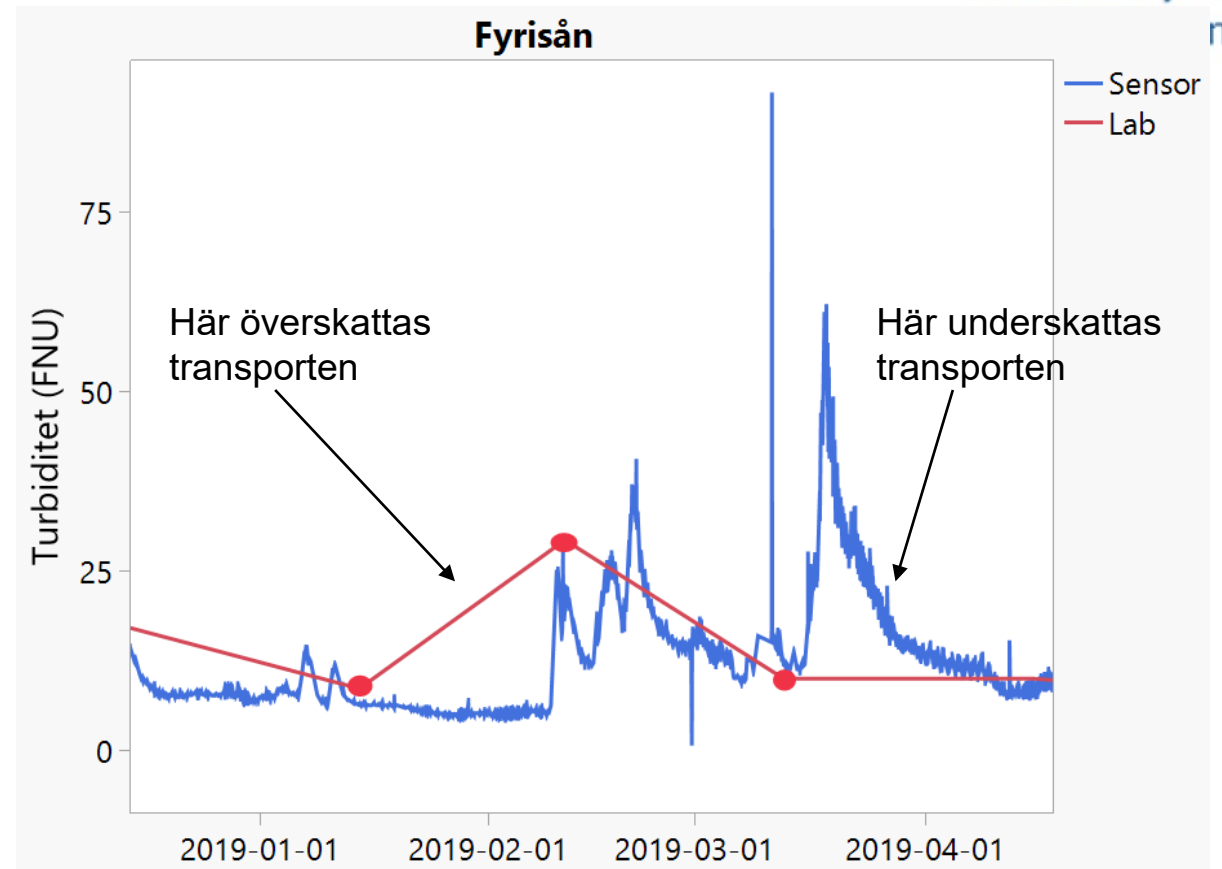

MÅNGA SÄTT ATT ANVÄNDA SENSORER



Funded by the
European Union

- Transportberäkningar
- Mätning under kortare perioder för att bedöma provtagningsbehov
- Processförståelse
- Larm till provtagaren om att ta extraprover för vattenkemi vid extrema förhållanden
- Dygnsvariation av syrgas
- Mätning av surstötarmed pH-sensor
- När vandrar Aspen upp i Fyrisån?

HUR OFTA BEHÖVER MAN ROVTA?



Funded by the
European Union



NORDBALT
ECOSAFE

HUR OFTA BEHÖVER MAN ROVTA?



Funded by the
European Union



NORDBALT
ECOSAFE

SYRGAS



Funded by the
European Union

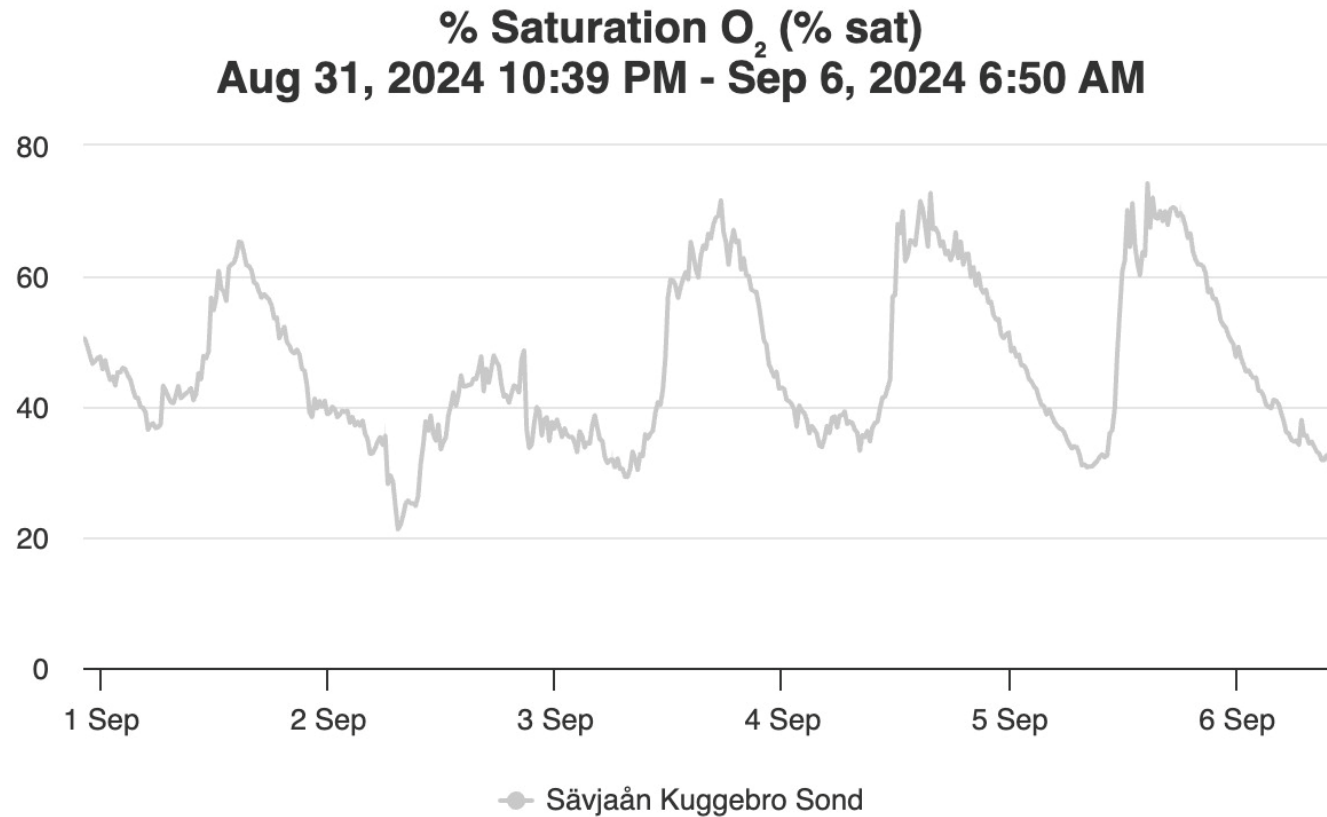



Funded by the European Union

Hågaån, Lurbo

Country: Sweden

National Station ID: 307264

Station name: Hågaån, Lurbo 200m uppströms bron

Catchment area: 119.50 km²

Soil type in catchment: moraine 26.59%, rock and thin soils 17.78%, peat 9.02%, coarse soil 0.14%, fine soil 19.95%, impermeable 2.67%, sand 0.007%, loamy sand 0.22%, sandy loam 0.01%, clay loam 2.20%, silty clay loam 3.31%, silty clay 15.48%, clay 1.25%

Land use in catchment: forest 53.04%, clear cut 2.50%, agricultural land 23.32%, urban areas 6.18%, open land 8.13%, wetland 6.31%, lakes & streams 0.52%

Catchment data source: SMHI, s-hype2022_version_2022a_1.0.0

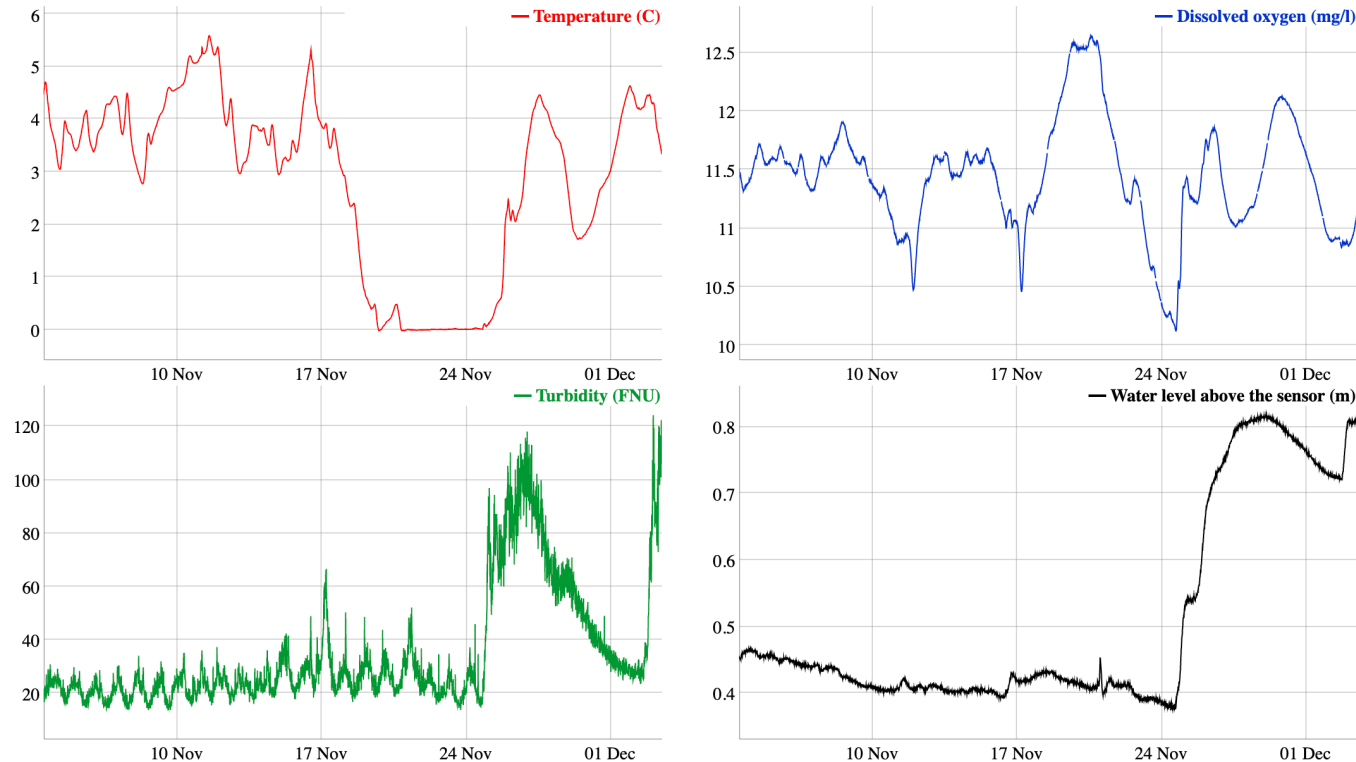

Note! Potential outliers are omitted from the plots based on 3 standard deviations during 1 day. For details on method see section "2.3.1. Quality control" in [publication](#).



Julmyrabäcken 2019

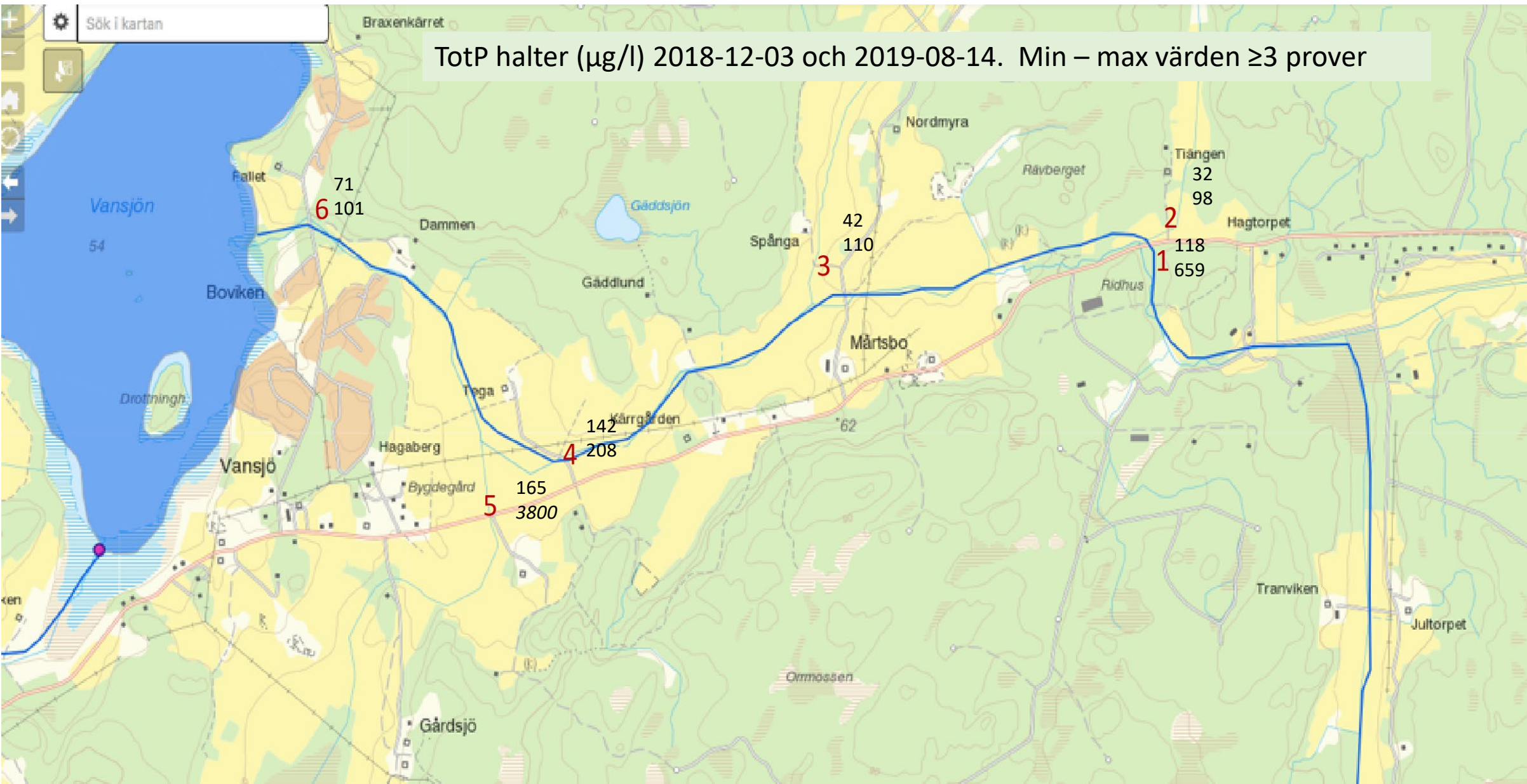

FRÅGOR?



Funded by the
European Union



DISKUSSIONFRÅGOR



Funded by the
European Union

1. Vilken nytta skulle ni kunna ha av sensorer med online visning i Örsundaån?
2. Vilken potential ser ni av att mäta med sensorer i kampanjer?



unded by the
uropean Union





Funded by the European Union

Dynamiken kan ge stöd för åtgärdsarbetet

Hysteresis- Sambandet mellan halt och flöde är olika i början och i slutet av en flödestopp

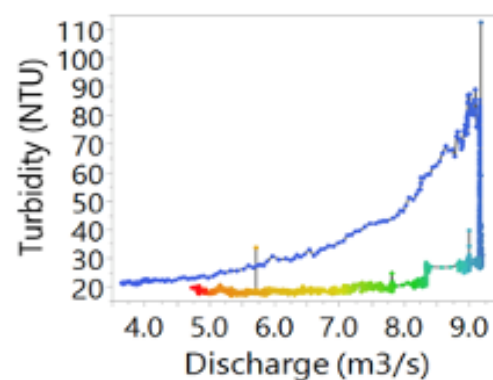
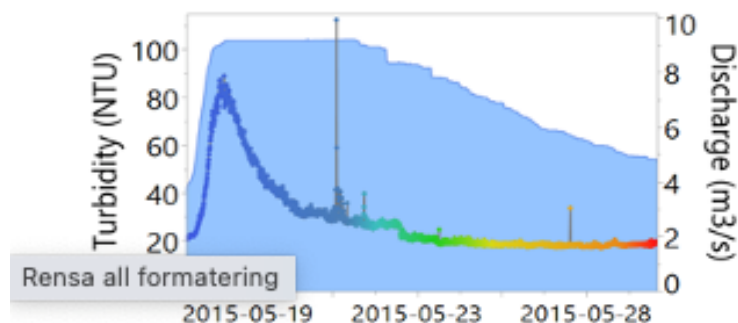

Högre halter i början -
utspolning

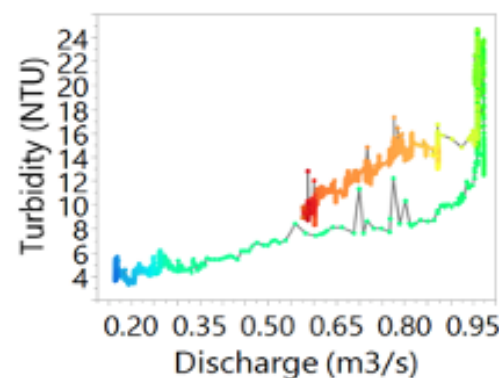
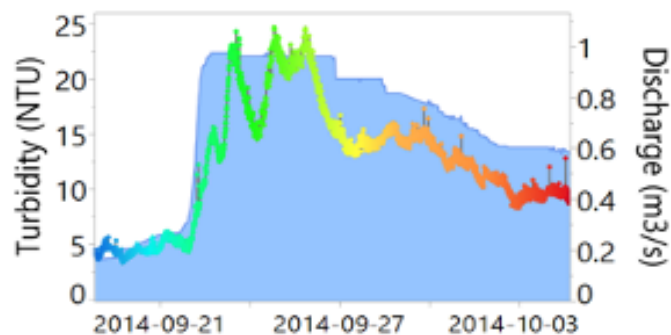

Högre halter i slutet -
erosion av mättad mark



Funded by the
European Union

NORDBALT
ECOSAFE

NÄRINGSRETENTION, UTSLÄPP AV VÄXTHUSGASER OCH EXTREMA VÄDERFÖRHÅLLANDEN

<https://projects.au.dk/nordbalt-ecosafe>

HURFUNGERRARVÅTMARKER



Funded by the
European Union



© Pia Geranmayeh



HUR FUNGERAR VÅTMARKER KOL



Funded by the
European Union



Fördelar	Nackdelar
Kol retention	Utslipp av Koldioxid



© Pia Geranmayeh



HUR FUNGERAR VÅTMARKER KVÄVE



Funded by the
European Union



Fördelar	Nackdelar
Kol retention	Utsläpp av Koldioxid
Borttagning av kväve	Utsläpp av lustgas

HUR FUNGERAR VÅTMARKER FÖR FOSFOR



Funded by the European Union

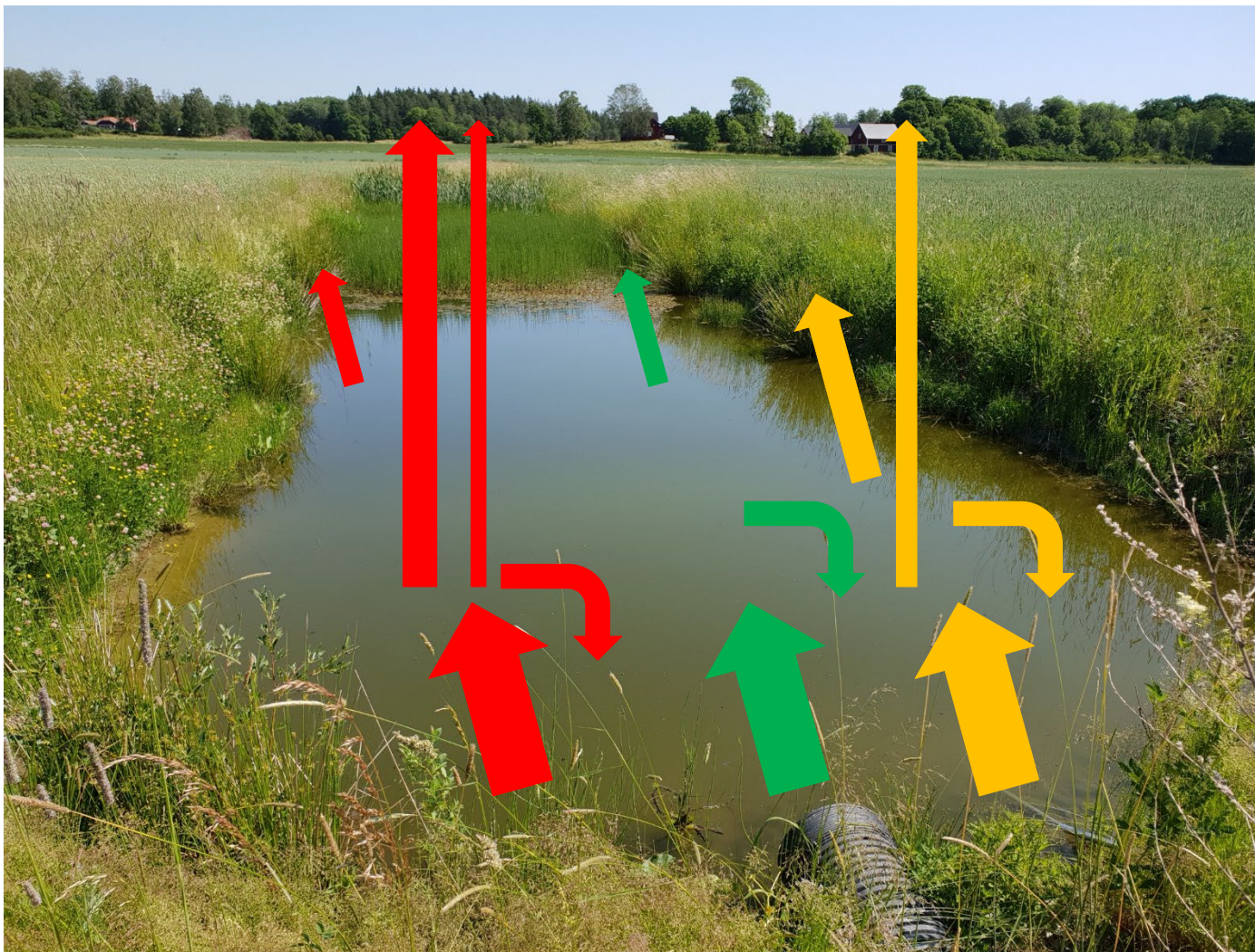

Fördelar	Nackdelar
Kol retention	Koldioxid utsläpp
Borttagning av kväve	Utsläpp av lustgas
Fosfor retention	

HUR FUNGERAR VÅTMARKER METAN



Funded by the European Union

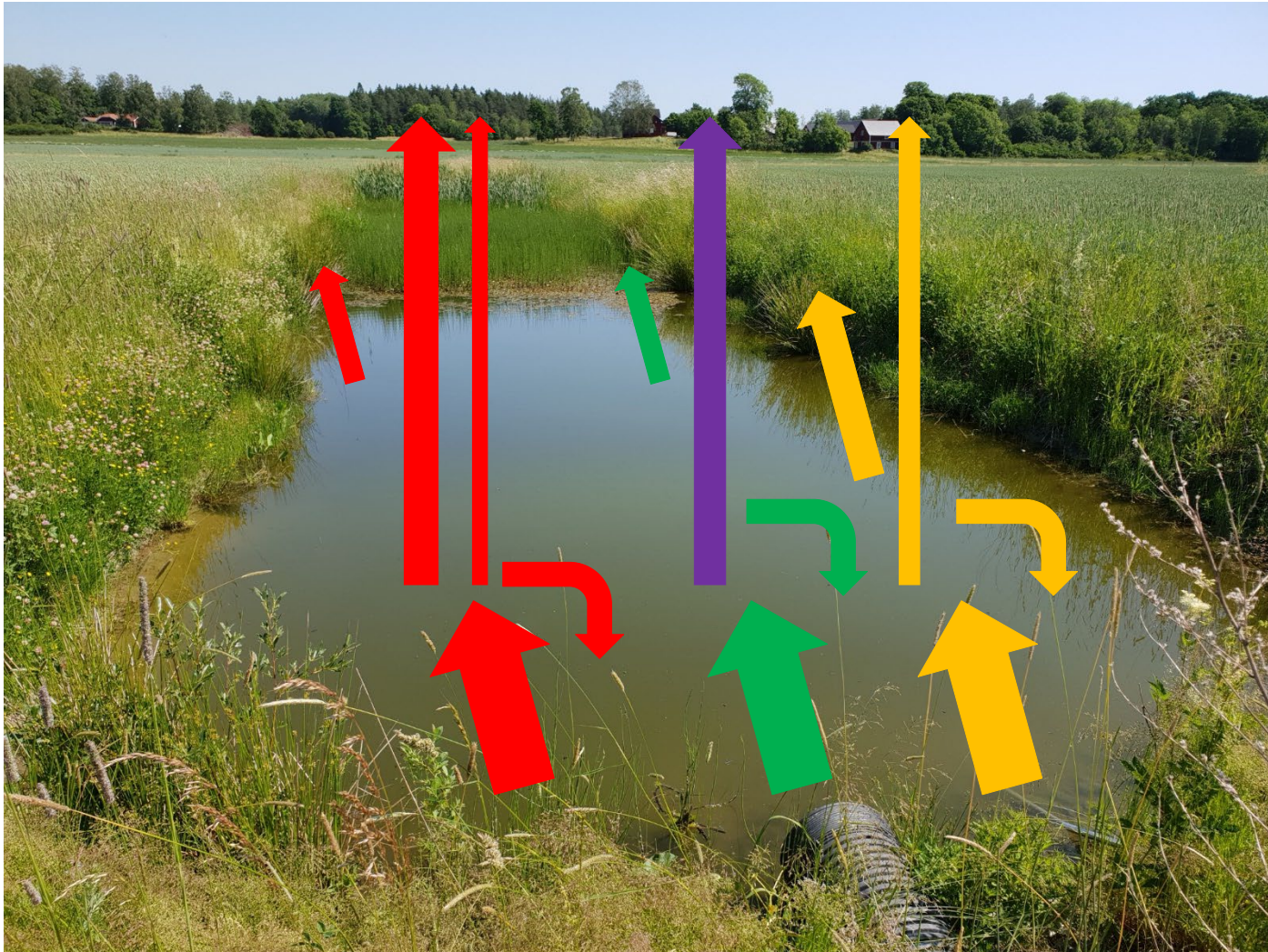

Fördelar	Nackdelar
Kol retention	Koldioxid utsläpp
Borttagning av kväve	Utsläpp av lustgas
Fosfor retention	Utsläpp av metan

HURTÄNKERJAG ?



Funded by the
European Union

Våtmarker har många fördelar,
t.ex. biologisk mångfald,
rekreation

Rening av näringsämnen, t.ex. i
avloppsreningsverk, påverkar
klimatet

Min tanke är att fler våtmarker är
bättre än inga alls

Fördelar	Nackdelar
Kol retention	Koldioxid utsläpp
Borttagning av kväve	Utsläpp av lustgas
Fosfor retention	Utsläpp av metan

EXTREMTVÄDER–TORKA OCH ÖVERSVÄMNINGAR



Funded by the European Union



© Pia Geranmayeh



EXTREMTVÄDER-ÖVERSVÄMNINGAR



Funded by the
European Union



Minskingar	Ökningar
Koldioxid utsläpp	Metan utsläpp
	Kolflöden
	Fosforflöden

© Länsstyrelsen Uppsala

EXTREMTVÄDER-TORKKA



Funded by the
European Union



Minskingar	Ökningar
Metan utsläpp	Koldioxid utsläpp
Kolflöden	
Kväveflöden	
Fosforflöden	

EXTREMTVÄDER–TORKA OCH ÖVERSVÄMNINGAR



Funded by the
European Union



TACK!

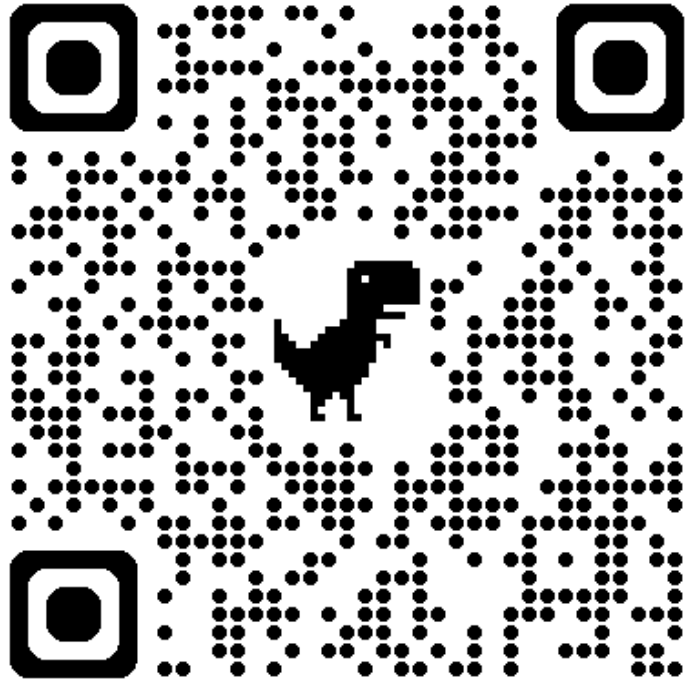

Funded by the
European Union



NORDBALT
ECOSAFE



Funded by the
European Union

Modellberäkningar för att skatta näringstransporter

- kan de användas för att bedöma effekter av extremväder

Kristina Mårtensson

<https://projects.au.dk/nordbalt-ecosafe>

Örsundaån

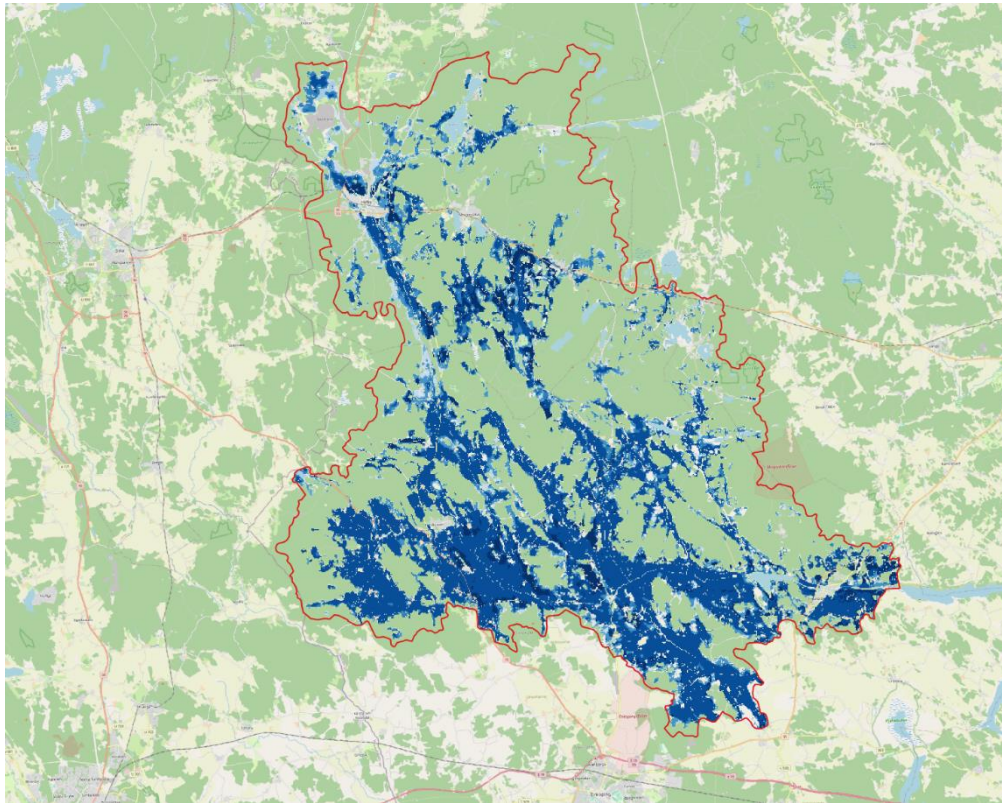

Jordarter

-  Sand
-  Loamy sand
-  Sandy loam
-  Loam
-  Silt loam
-  Silt
-  Sandy clay loam
-  Clay loam
-  Silty clay loam
-  Sandy clay
-  Silty clay
-  Clay

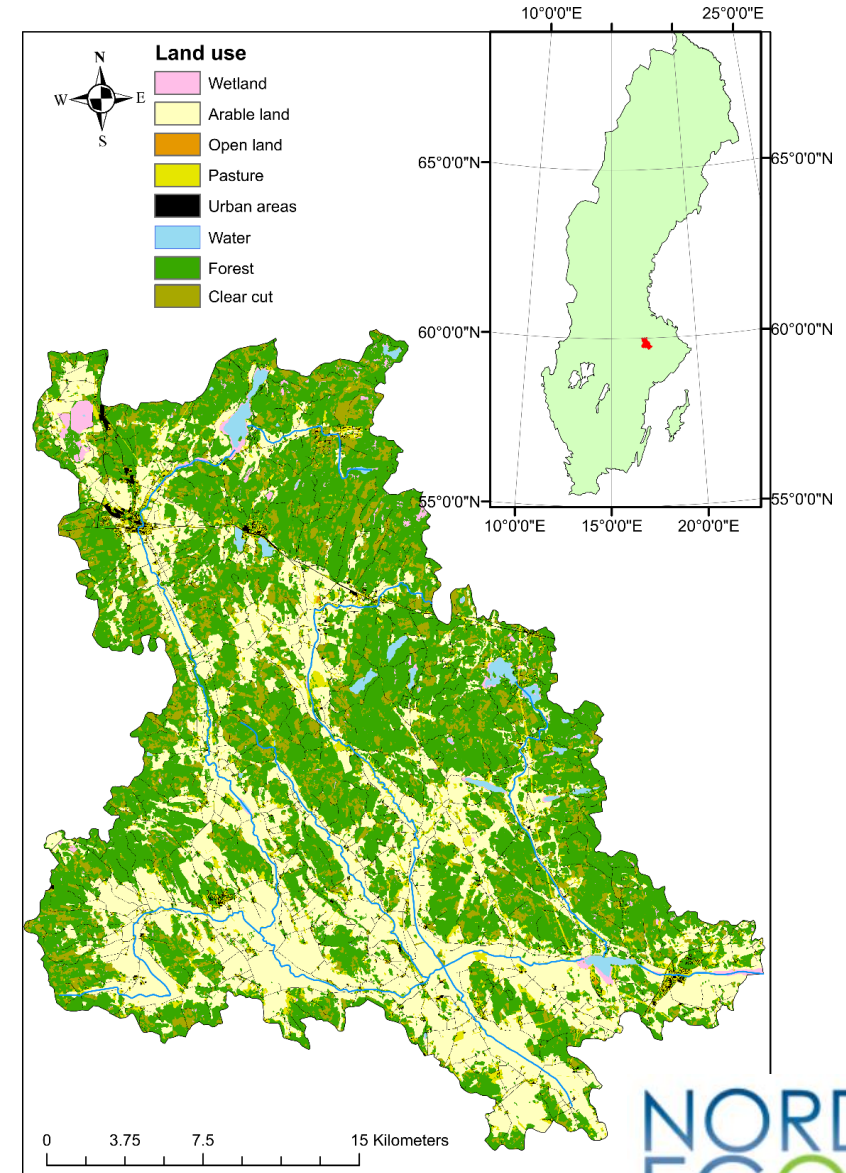

Mälar- och Hjälmabygden

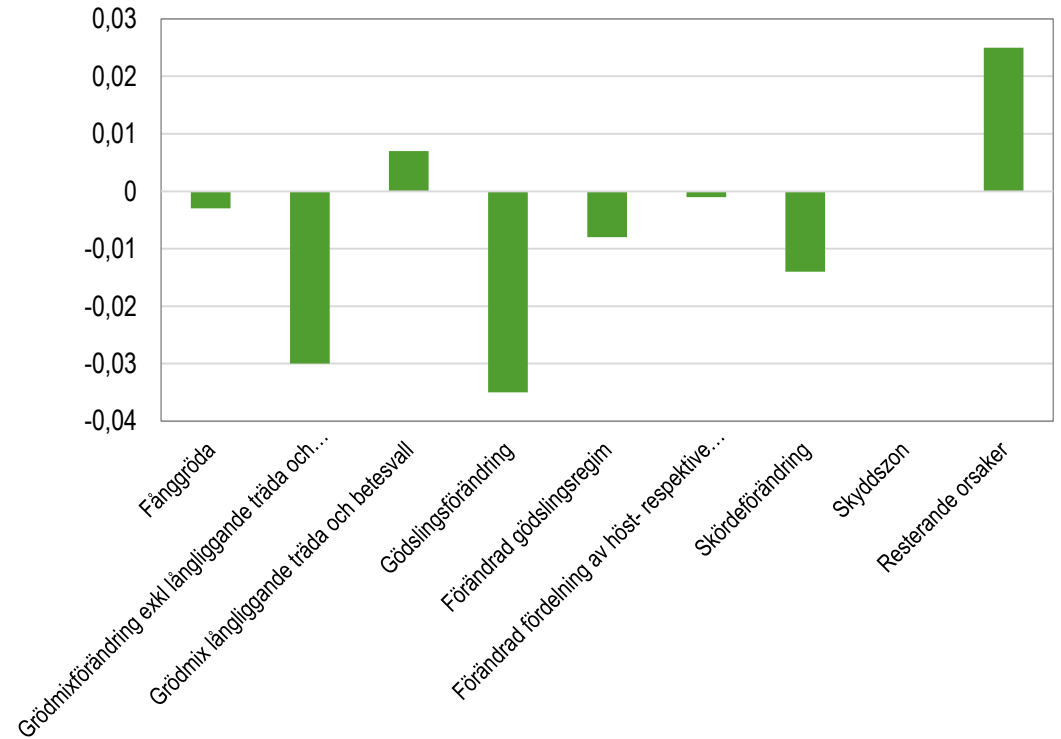
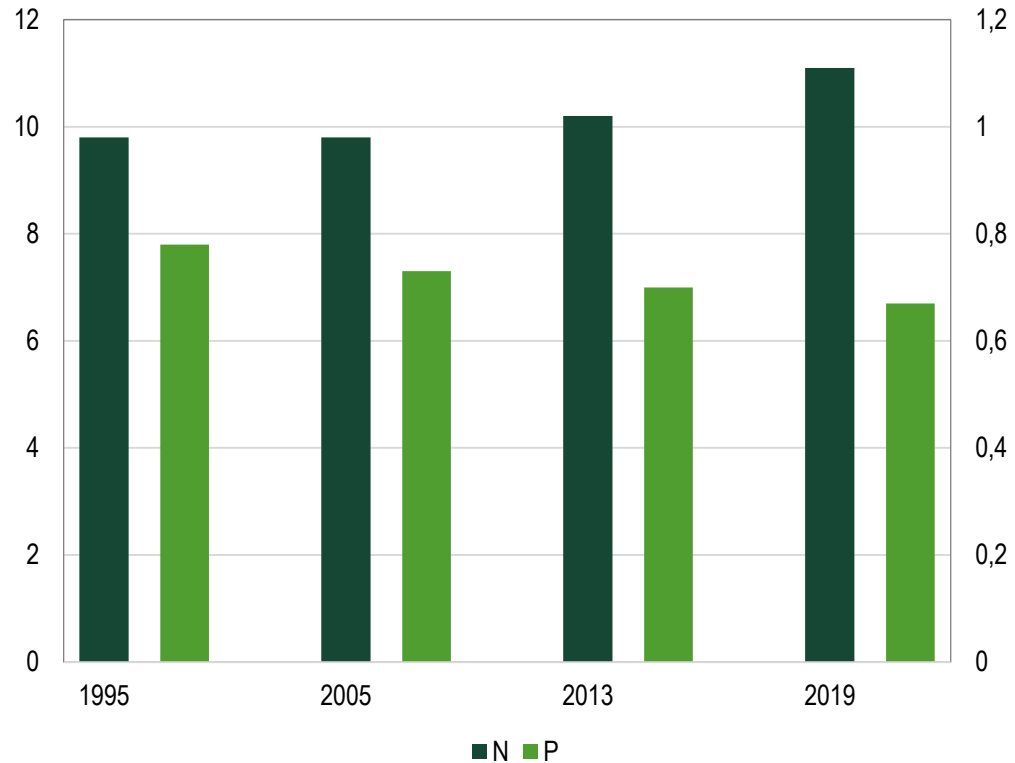

Modellerat normalläckage (kg/ha) och olika orsakers bidrag till förändringar från 2005 till 2019 (kg P/ha)

Grödor

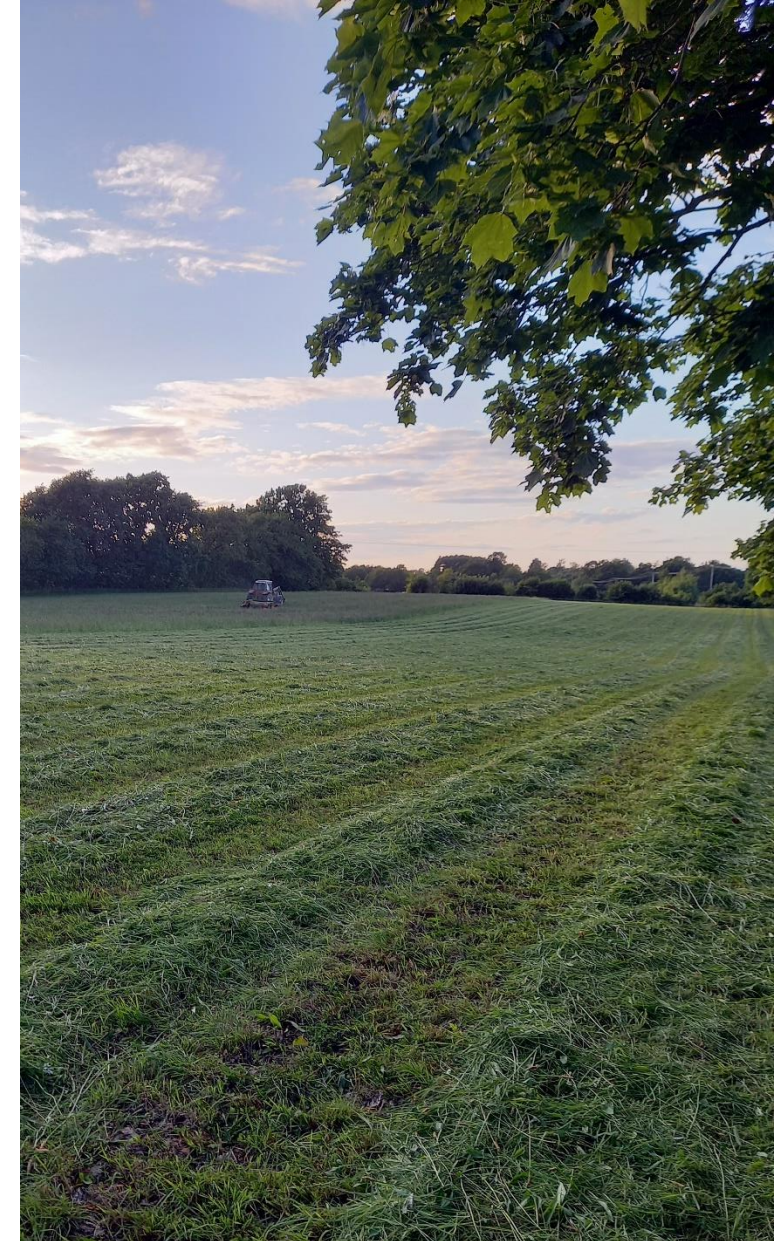
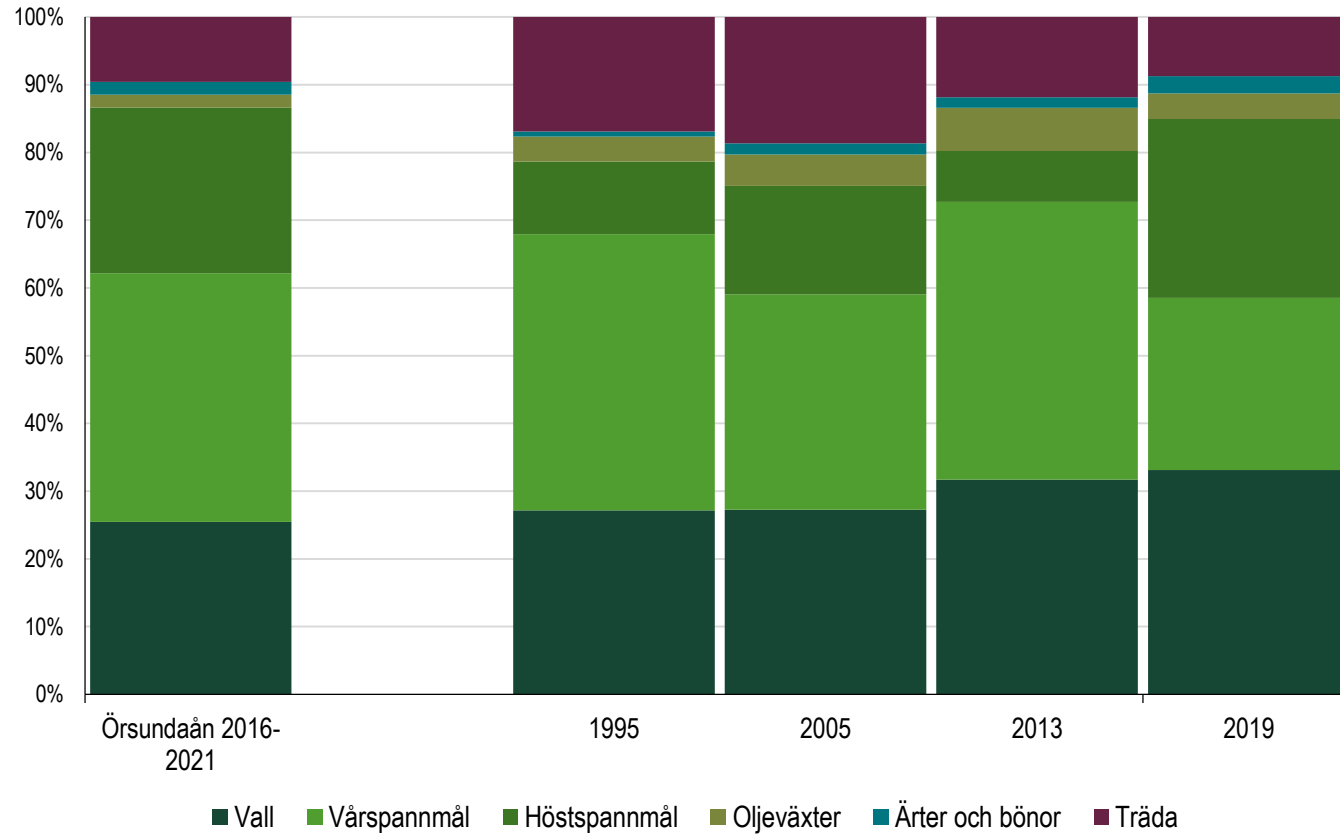

Gödsling och skörd

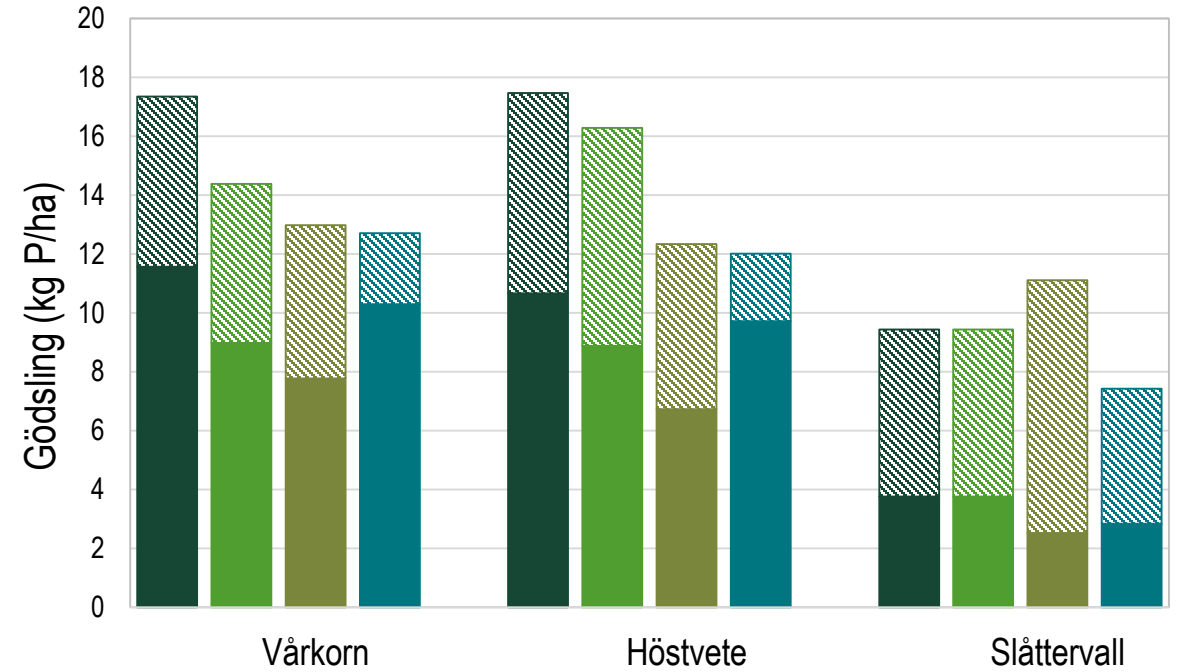
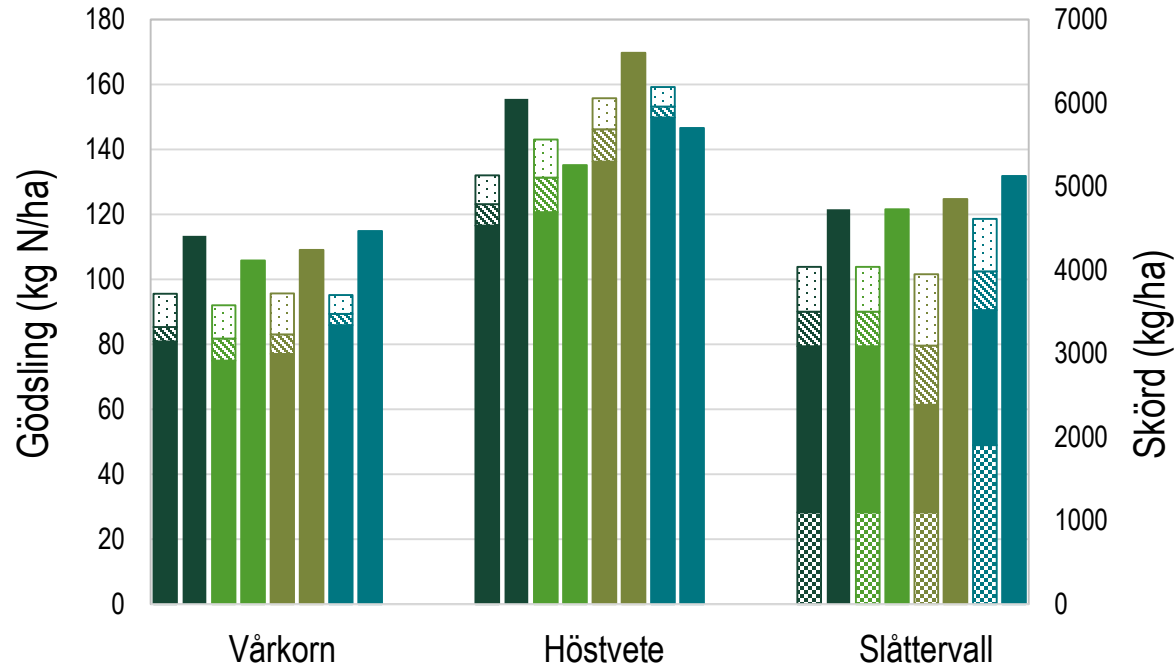

■ N-fix 2005 ■ minN 2005 ■ NH4 2005 ■ orgN 2005
 ■ N-fix 2013 ■ minN 2013 ■ NH4 2013 ■ orgN 2013
 ■ N-fix 2019 ■ minN 2019 ■ NH4 2019 ■ orgN 2019
 ■ N-fix 1995 ■ minN 1995 ■ NH4 1995 ■ orgN 1995
 ■ Skörd 1995 ■ Skörd 2005 ■ skörd 2013 ■ skörd 2019

■ min 1995 ■ stg 1995 ■ min 2005 ■ stg 2005
 ■ min 2013 ■ stg 2013 ■ min 2019 ■ stg 2019

Klimat

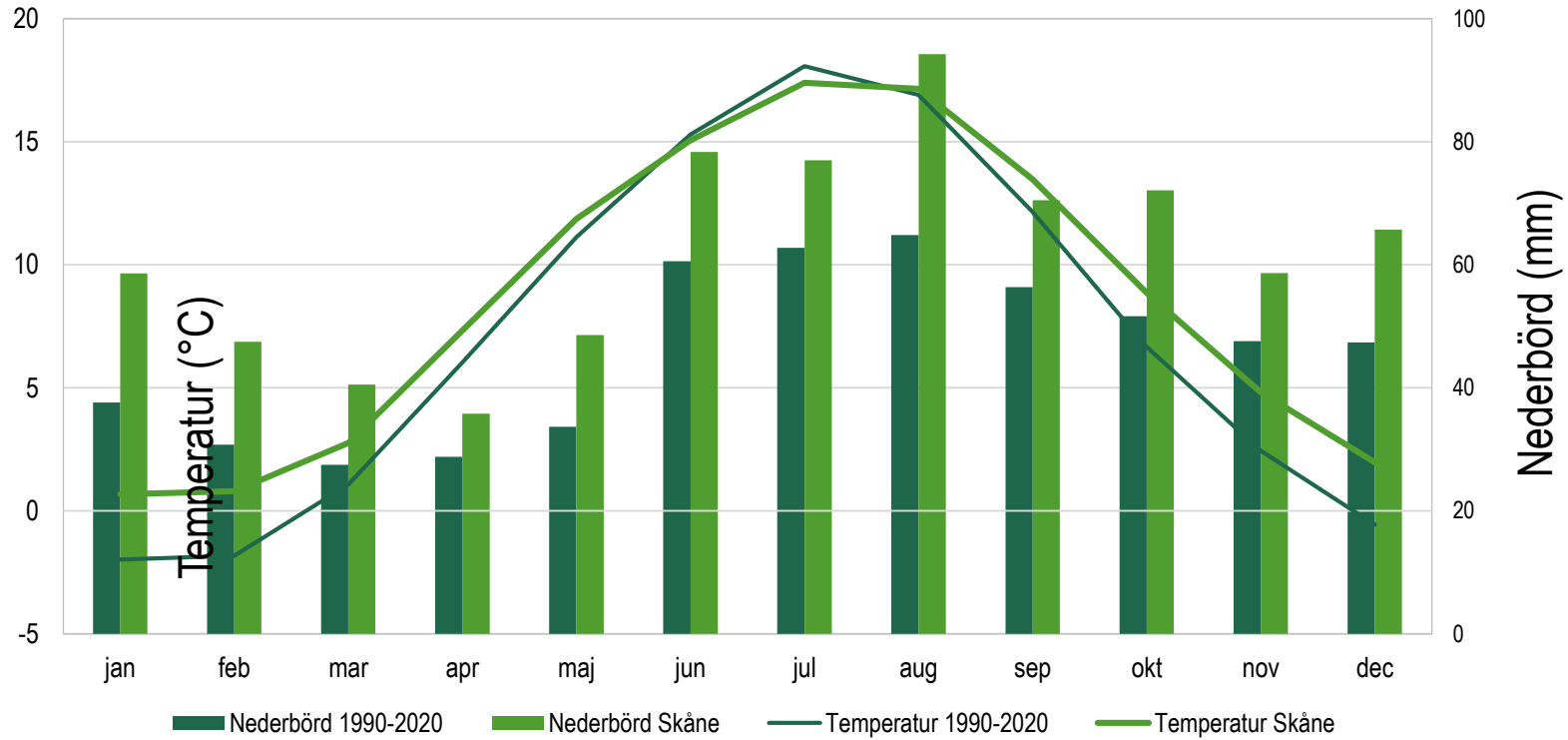



SCIENCE AND
EDUCATION

SUSTAINABLE LIFE FOR FABLE



SCIENCE AND
EDUCATION **FOR**
SUSTAINABLE
LIFE



SCIENCE AND EDUCATION
FOR SUSTAINABLE LIFE

NORDBALT
ECOSAFE



Funded by the
European Union

ÅTGÄRDER FÖR MINSKAT NÄRINGSLÄCKAGE

<https://projects.au.dk/nordbalt-ecosafe>

Åtgärder från gröda till vattendrag



Åtgärder mot övergödning

- › Åtgärda i första hand vid källan
- › Välj åtgärd efter platsens egenskaper och behov av näringsreduktion

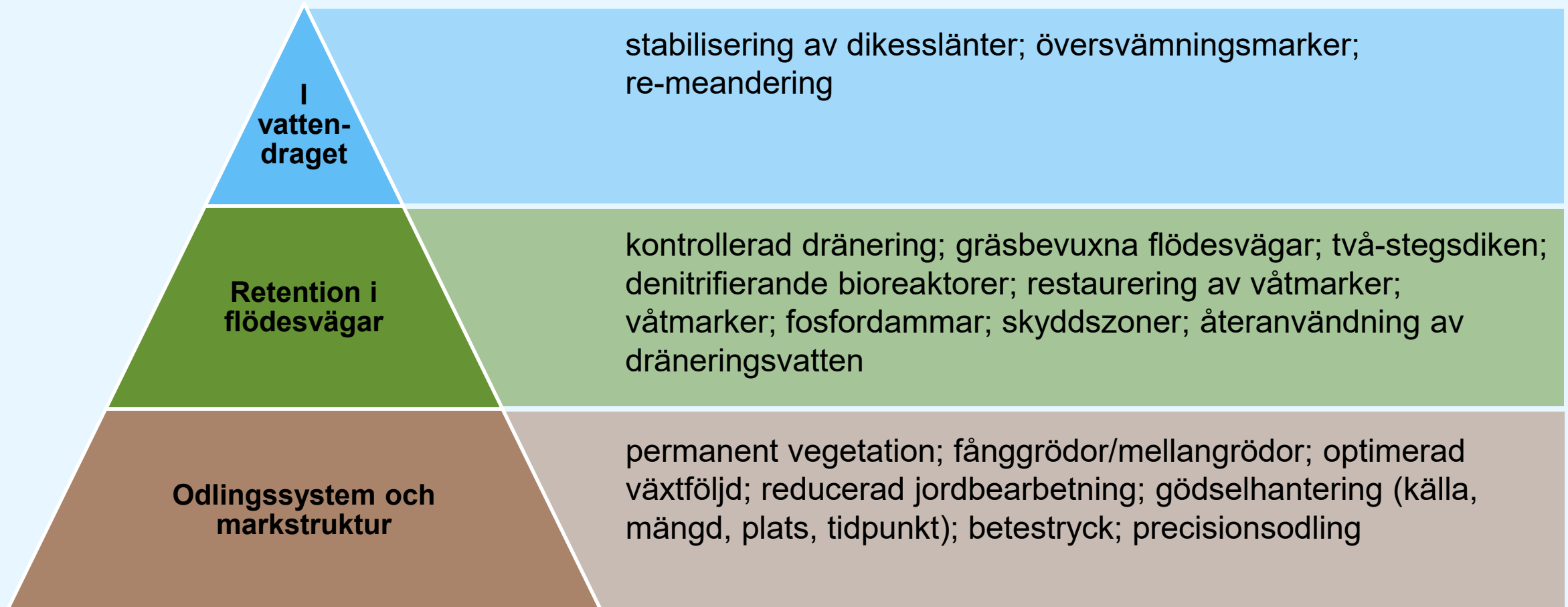

Klassificering av åtgärder mot övergödning

Norden och länder runt Östersjön

	DK	NO	SE	FI	LV	PL
Field mitigation measures						
Crop rotation			X		X	X
Catch crops and intermediate crops	X	X	X	X	X	X
Early seeding of winter crops	X					X
Permanent set aside	X		X	X		X
Set aside in rotation	X		X	X	X	X
Permanent grassland, meadows and pastures					X	X
Energy crops	X		X		X	X
Afforestation	X		X			X
Reduced tillage and direct seeding	X	X	X	X	X	X
Reduced tillage - no tillage in autumn		X	X	X		X
Mulching						X
Subsoiling						X
Application of gypsum or structure lime			X	X	X	X
Precision fertilization (fertilizer & manure)	X	X	X	X	X	X
Reduced fertilizer use	X				X	X
Nitrification inhibitors to slurry	X					
Manure application regulations			X		X	X
Limits for N- and P-use in manure	X		X			X
Transport mitigation measures						
Surface constructed wetlands	X		X		X	
Restored wetlands	X	X	X	X	X	X
Bioreactors with wood chips	X			X		
Controlled drainage	X		X	X		X
Inundated meadows with drainage water	X					
Paludi cultures	X			X		X
Buffer strips with grass or trees	X	X	X	X	X	X
Integrated and Saturated Buffer Zones	X					
Grassed waterways		X	X			X
Grass cover/no tillage in areas with high flood and/or erosion risk		X	X		X	X
In-stream mitigation measures						
Constructed wetlands	X	X	X	X	X	X
Sedimentation ponds in forests		X	X	X		X
Re-meandering of river channels	X	X	X			X
Two stage ditches and channels	X		X	X		
Stream bed re-naturalization						X

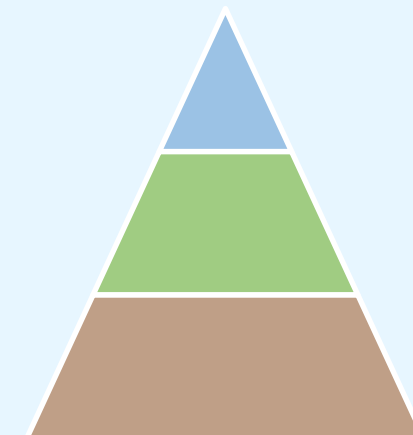



SCIENCE AND EDUCATION
FOR SUSTAINABLE LIFE

Hållbar produktion i ett förändrat klimat

Näringsämnen
och växtskydds-
medel

Kolbalans och
växthusgaser

Vatten-
hushållning

Biodiversitet
och landskaps-
struktur

Markhälsa

Hållbar produktion inte bara ekologiskt utan också ekonomiskt och socialt

Många aspekter



Waterdrive Catalogue of measures

Agri-environmental measures around the Baltic Sea



Waterdrive

In the Waterdrive project (2019–2021) solutions for integrated and sustainable water management in the agricultural landscape are explored. Cross-sectorial collaboration and partners from all countries around the Baltic Sea enhance effective exchange of experiences

Field

Field to stream

Stream

Catchment

The Catalogue

Water and nutrients are transported from the fields through drainage systems and out to the stream. To have a landscape perspective is crucial in water management. Many types of measures all together make the difference.



Many aspects on measures

Water management measures in the agricultural landscape are central in the progress to reach sustainable development goals. Knowledge on functionality and effectiveness under various local conditions is needed for cost-effective localisation

Buffer zones along waters

LAST CHANGED: 30 APRIL 2022

Buffer zones (BZs) between pollutant source area and receiving waters is a supplementary measure to prevent runoff of sediments, nutrients and other pollutants.

A buffer zone with permanent vegetation cover locates generally between an agricultural field and a receiving water body or main ditch having several benefits. The BZ prevents the application of fertilizers, manure, and pesticides too close to an adjacent water body, brook, or main ditch since these operations as well as soil tillage are not allowed in BZs. It not only controls erosion on the slope but also removes sediment, nutrients, and other pollutants from surface runoff. In addition, the BZ enhances the biodiversity and especially can increase the number of pollinators.



Buffer zones can control loading in several ways. Firstly, dense vegetation in the BZ increases the hydraulic roughness reducing the overland flow velocity and sediment transport capacity. At the same time, eroded soil particles are settled in the BZ and particle bound nutrients and pollutants are retained. Secondly, phosphorus is adsorbed in the soil surface whereas soluble nutrients and compounds infiltrate with runoff water into the ground. Thirdly, the vegetation in the BZ adsorbs pollutants from the surface runoff and roots take up nutrients from the soil.

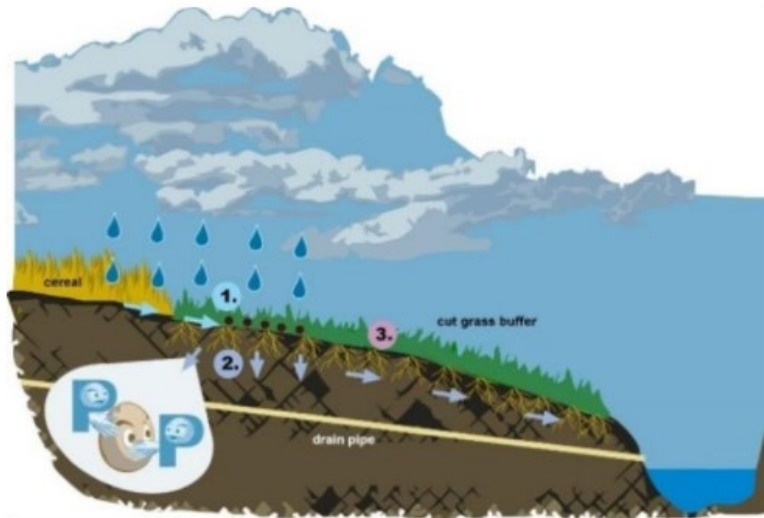

Retention processes within BZs: 1. Deposition of sediment; 2. Adsorption of phosphorus in soil surface or/and infiltration of runoff into soil; 3. Plant uptake of nutrients. Picture: Ulla Jauhainen, Luke, Finland.

Localisation and implementation

Buffer zones are generally established between lower field edges and main ditches or water bodies, but more than one edge may also be buffered in the same field. The width of BZ depends on the erodibility of the protected field and slope. The longer, steeper or more erodibility the slope, the wider BZ is needed. A narrow headland is enough along the main ditches or a 3-m-wide buffer strip along brooks on flat soils whereas more than a 10-m-wide BZ may be needed on steep and long slopes with high erodibility. Modelling and GIS tools are useful in planning the right kind of BZ in the right place.

Buffer zones may also exist on arable land in ground water areas or in Natura 2000 areas where they may e.g. retain harmful substances attached to water percolating into deeper soil layers or into ground water. In some cases, BZs could be left on a field area e.g. to cut a long slope or retain water on a concentrated area of water flows in the field.

Effects, duration and maintenance

Buffer zones are effective in decreasing soil particles and particle bound phosphorus (PP) in surface runoff from autumn ploughed soils having high erodibility. They are also useful for grassed and directly drilled fields with low erosion because they maintain sufficient distance between the source field with manure, fertilizer or pesticide application and the water body. The retention efficiency is better in autumn than in spring due to dense vegetation in autumn compared to decaying grass during spring snowmelt and rains.

Biomass harvest is recommended to remove nutrients from the BZs. The P sorption capacity may decrease during time since part of the P from source field and decaying grass is adsorbed in the surface soil.

Effects							
Water retention	N retention	P retention	Groundwater infiltration	Productivity	Biodiversity	Carbon storage	GHG reduction
Good/positive	Good/positive	Good/positive	Unknown	Not relevant	Good/positive	Moderate	Good/positive

■ Good/positive
■ Moderate
■ Negative
■ Unknown
■ Not relevant

Buffer zones - extended description ▼

Buffer zones - links to resources ▼

Authors:

Jaana Uusi-Kämpä and Tapio Salo, Natural Resources Institute Finland (LUKE), Finland.

Contact:

Jaana Uusi-Kämpä, Natural Resources Institute Finland (LUKE), Finland. [e-mail](mailto:jaana.uusikampa@luke.fi)

Åtgärds kataloger i många projekt

- Olika behov hos vattenmyndigheter, kommuner, rådgivare, lantbrukare etc.
- Behöver integrera all typ av information om åtgärder – även praktiska erfarenheter
- Ska leva vidare efter projektens slut - hur kan den förvaltas?
- Kan vi skapa en gemensam katalog - ex genom Wikipedia, VISS?

Örsundaåns avrinningsområde



Valencia juli 2019

Erosion i odlingar utan
terasser



Infiltration i terassodling

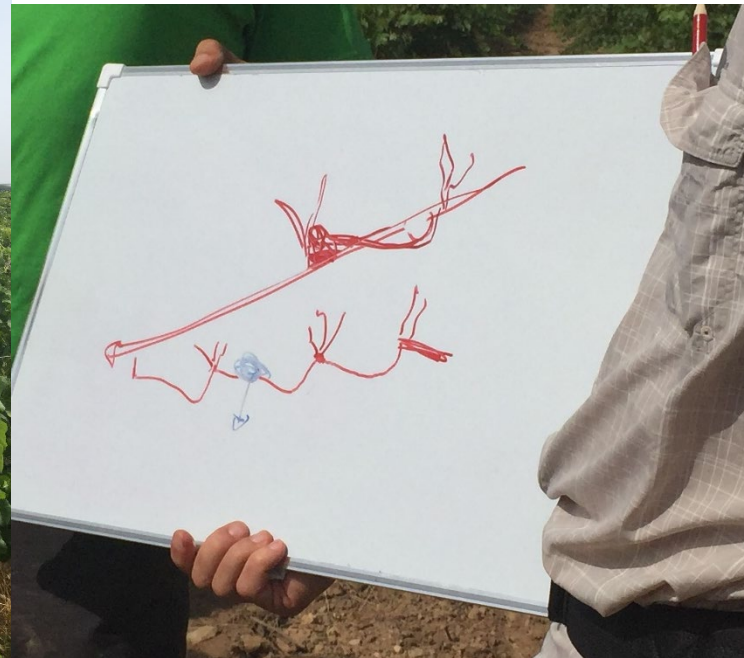



NORDBALT
ECOSAFE



Funded by the
European Union

STYRMEDEL

– räcker de för behovet av åtgärder

<https://projects.au.dk/nordbalt-ecosafe>

Åtgärder mot övergödning i Ecosafe 'case areas'

Norge

Fosfor och sediment – erosionsåtgärder, bl.a. bevuxna vattenvägar
Kväve – nytt problem i Oslofjorden

Finland

Fosfor i lerjordar – fältåtgärder bl.a. inblandning gips

Polen

Fosfor från reningsverk – åtgärder har gett effekt

Danmark

Kväve i kustområden – många åtgärder för att minska tillförseln

Odense Å i Danmark - kväve

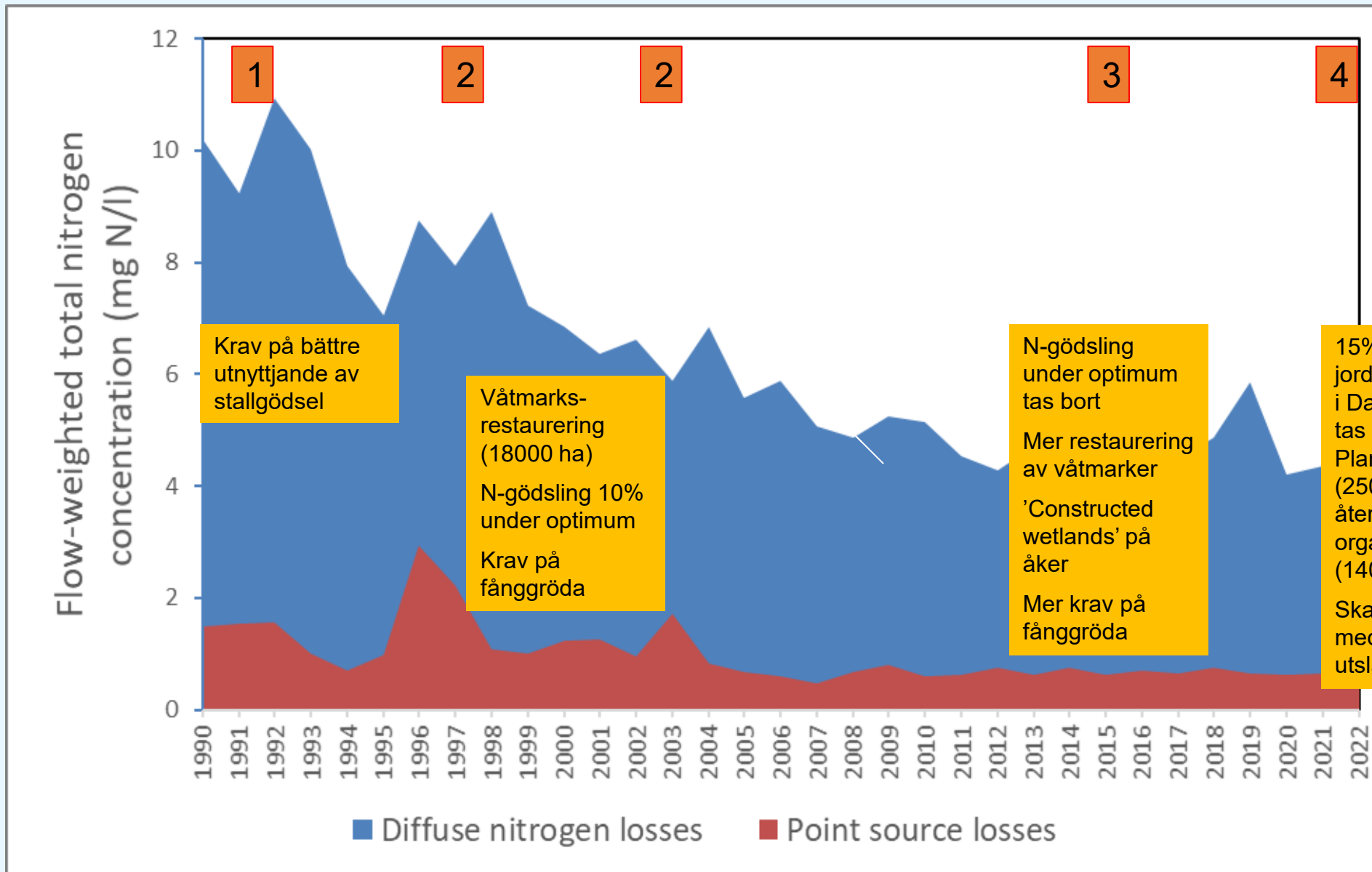

Politisk konsensus
Modell för värdering av land och landbytte

Fler kan nu söka EU-stöd för investering i dräneringen

I en väl-dränerad jord utvecklas rotsystemen bättre vilket ger motståndskraft mot både torra och blöta perioder och därmed bättre produktion



321 miljoner extra till täckdikning av åkermark

Länsstyrelserna får nu drygt 321 miljoner kronor extra att fördela till stöd för täckdikning av åkermark. Lantbrukare kan söka dessa medel inom Investeringstöd för ökad konkurrenskraft, för ny- och omläggning av täckdikning på åkermark.

[Läs hela nyheten](#)



NORDBALT
ECOSAFE



Funded by the
European Union

Örsundaåns avrinningsområde – temadag om extremväder och vattenkvalitet

Nysätra gamla skola, Örsundsbro, torsdag 5 december 2024

I mötet deltog representanter från Enköpings kommun, Heby kommun, Länsstyrelsen i Uppsala län, Hushållningssällskapet, lantbruksnäringen samt SLU. Samtliga deltagare arbetar med vattenfrågor i sina respektive verksamheter.

Referensvärden och mål för vattenkvalitet (JF)

- Stora skillnader i hur olika EU-länder klassar vattenkvalitet. Inom EU genomfördes en omfattande interkalibrering för att säkerställa enhetlighet i klassificeringen, men detta gällde enbart biologin. För några år sedan började man granska fosforhalter mer ingående och såg att god/måttlig status varierar från 10 till 1 000 mikrogram/liter mellan länder.
- Vissa deltagare upplever att referensvärdena inte är tillräckligt anpassade till jordbrukets variationer. Till exempel har man här i Örsundaån emellanåt styva leror som har en tendens att läcka betydligt mer än Skånes lättare jordar gör. Det ställdes frågor om uppdateringarna kommer att innebära lokala anpassningar av referensvärdena. Svaret är att den nya bedömningen kommer att ha bättre precision, bland annat genom att genomsnittliga lerhalter i avrinningsområdena tas i beaktande.
- Möjlighet till lokala data i bedömningar - Framhölls av deltagare att det finns juridiskt utrymme att använda egna data som underlag för att justera kraven, om dessa avviker från den nationella klassningen. En kommun nämnde att de genomfört egna provtagningar och skickat in resultaten som grund för nya bedömningar.
- Effekter av klimatförändringar på klassgränserna: ev. att man kommer behöva ändra klassgränserna om systemet blir känsligare eller tvärtom - e.g. lägre syrgashalter eller brunare/grumligare vatten - dessa faktorer är komplexa, och man har påbörjat modellering för att bättre förstå sambanden.
- Egenkontroll för markägare - en deltagare frågade om det finns några typer av mätningar som lantbrukare eller markägare själva kan utföra, vilket ledde in på nästa ämne.

Sensorer för realtidsvisning online eller enkla teststickor (JF)

- Skyddade sensorer för kontinuerlig datainsamling - Berättade om arbetet med sensorer som placeras i plaströr så att de kan sitta skyddade, t.ex. under isen. Dessa sensorer mäter kontinuerligt och skickar data som kan följas online.
- Vid månadsvis mätning kan man ibland träffa en topp, vilket leder till en överskattning av transporten under perioden. Oftast missar man dock topparna, vilket resulterar i en underskattning av transporten. Sensorerna bidrar till att bättre avgöra hur frekvent provtagning behövs i ett specifikt vattendrag.
- Sensorer täcker inte alla önskade platser, men kan larma vid behov av extra prover. Då kan man utföra synoptisk provtagning och skicka prover till labb. Eftersom labbprover är dyra finns även testkit (för fosfat, ammonium och nitrat) som mäter och ger ett digitalt värde. Begränsad erfarenhet inom projektet av dessa än så länge, så deras noggrannhet är inte fullt utvärderad, men de är användbara för att utföra många tester, exempelvis för att identifiera läckage från enskilda avlopp.
- En kommun lyfte fram att även om de använder sensorer saknas ofta resurser och kompetens för att tolka insamlad data och använda modeller för att dra korrekta slutsatser. Det finns behov av enkla verktyg och indikatorer för att underlätta tolkningen av data.
- SLU svarade att man byggt ett system för att kvalitetssäkra sensorernas data - rensa den och sammanställa årsrapporter - men även med enkla verktyg riskerar man att övertolka resultaten. Det krävs alltid en kombination av enkla datasystem, lokal kunskap och expertbedömningar för att säkerställa relevanta analyser. Diskussioner fördes om möjligheten att använda modeller för att bättre förstå och dra slutsatser av insamlade data.

Växthusgaser och näringsförluster (MF)

- Tre kemiska element är viktiga för att förstå hur våtmarker fungerar: kol, kväve och fosfor. Kol rinner in i våtmarken, och en stor del lagras i sedimentet. Risk för koldioxidutsläpp men inte påtaglig, vilket gör våtmarker värdefulla för kolretention. Kväve lagras delvis i sedimentet, delvis rinner ut, men en betydande del omvandlas till kvävgas. Detta minskar belastningen på Östersjön men kan leda till utsläpp av lustgas. Fosfor fäster ofta i sedimentet, men kan läcka vid syrefattiga förhållanden. Metanutsläpp kan också öka i fosforrika våtmarker på grund av mikrobiell aktivitet.
- Utmaningar med våtmarkers funktion – Exempelvis kan våtmarker bidra till metanutsläpp, särskilt vid översvämningar. Översvämningar kan också öka läckaget av kol och fosfor. Vid översvämning frigörs fosfor från marken, särskilt i syrefattiga miljöer. Vid torka kan utsläppen av koldioxid minska men öka av metan. Utflödet av näringsämnen minskar under torkan men läckaget av kväve kan öka efter torkan som följd av att organiskt material i marken har brutits ned när syre har tillförts.
- Men många fördelar som väger upp med våtmarker - Biologisk mångfald: Skapar livsmiljöer för många arter. Rekreation: Bidrar till kulturella och sociala värden. Vattenrening: Effektiv retention av näringsämnen och minskning av föroreningar. Viktigt bara att välja plats i landskapet där effekten bedöms bli bäst, dvs hög näringsbelastning om syftet med våtmarken är näringsretention.

- En fråga som diskuterades var om man kan använda diken som fosforfällor, så att man om möjligt kan planera underhåll med hur mycket man vet har samlats, och vad för vegetation som är bäst i slänter för att optimera näringsretention. Kommunen skulle vilja ha en manual som beskriver exakt hur man ska göra.

Modellberäkningar för att skatta näringstransporter (KM)

- Vid modellering på nationell skala används klimatserier över 30 år, vilket fångar normalsituationer snarare än Extremsituationer.
- Analysen för perioden 1995–2019 visar att kväveförluster har ökat något medan fosforförluster har minskat, bland annat på grund av förändringar i grödfördelning och gödsling. Bättre precision och effektivitet i gödsling kan ha bidragit till minskade näringsförluster - varierar mellan olika odlingszoner.
- Scenarier med förändrat klimat - Scenarier diskuterades utifrån ett förändrat klimat med varmare vintrar och förändrad nederbördsmängd, med Skåne som referens.
 - o Förändrade nederbördsmönster och temperaturer kan påverka grödval, till exempel ökad odling av höstgrödor eller introduktion av nya grödor som majs.
 - o Extensivare odling med fokus på vall och betesmarker framhölls som en potentiell strategi för att minska näringsförluster, men detta kräver samtidigt en förändring i djurhållningens struktur.
 - o Direktsådd och minimerad jordbearbetning togs upp av deltagare som en trend och möjlig framtida jordbruksstrategi.
- Politiska beslut och hållbarhet - En deltagare betonade att möjligheten att minska utlakningsförluster finns om de politiska besluten prioriterar utlakningsproblemen. Det behövs att politiska beslut stödjer långsiktig hållbarhet.

Åtgärder för minskat näringsläckage (KK)

- Helhetsperspektiv på åtgärder - Åtgärder behöver genomföras ända från gröda och ut i vattendraget. Exempel inkluderar att hålla marken bevuxen, vilket ofta är den mest effektiva metoden för att minska läckage; säkerställa en bra markstruktur och att dräneringssystemen fungerar korrekt; åtgärder i vattendragen, exempelvis att utforma slänterna rätt eller anlägga våtmarker.
- Kunskapsdelning och åtgärds katalog - Det är viktigt att samla och dela erfarenheter om hur olika åtgärder fungerar. SLU arbetar med att vidareutveckla en åtgärds katalog (som togs fram i Waterdrive-projektet) som har enkla beskrivningar av hur åtgärder fungerar, var de är lämpliga att genomföra, långsiktiga effekter och skötselbehov etc.
- Exempel från Tämnaren, Heby togs upp av deltagare: Ett område med mycket låg mark som årligen svämmas över. Trots detta plöjs marken på hösten, med förhoppning att vattnet drar sig tillbaka så att sådd kan ske på försommaren. Detta är mindre lämpligt jämfört med att använda marken till vall. Utmaningen är att det saknas incitament för detta när djurhållning inte är aktuell.

- Tidigare fanns vallstöd som är på väg att introduceras igen. Men det lyfts av deltagare att det skulle fortfarande vara ett problem i och med att man får avdrag vid kontroller om det är för blött. Skulle behövas ett nationellt stöd som går in och finansierar de åren när långliggande vall blir översvämmad, som täcker kostnaden att t.ex. köpa in foder från annat håll. Eftersom att man "offrar" sin mark och låter vattnet ligga där. T.ex. 2021 var det markägare som "straffades" för att deras mark var översvämmad och man kunde då inte släppa djur på bete - därför för mycket tillväxt i vallen vid tillsynsbesök.
- Vi diskuterade behovet av att skydda nedströms bebyggelse och infrastrukturer från att skadas av översvämningar. Här är det viktigt att det finns ytor längre upp i avrinningsområdet där marken tillåts översvämmas. Låglänt mark kring sjöar är sådana ytor som bör reserveras som buffert för att utjämna höga flöden. För att detta ska fungera behöver man hitta överenskommelser mellan kommun, markägare och brukare som tar hänsyn till alla parter behov.
- Utmaningar med eftersatta dräneringssystem - Dräneringssystemen ofta i dåligt skick, togs upp av deltagare att det är delvis eftersom att priset för ett väl-dränerat arrende är det samma som för odränerad. Stora förvaltarna har olika modeller som slår olika, det är väldigt stor skillnad på vad arrendatorn får betala för att underhålla dränering.

Regler, stöd och rådgivning (KK)

- Inom Ecosafe har vi undersökt hur styrmedel ser ut i olika länder. I Danmark har man beslutat att 15 % av jordbruksarealen ska tas ur bruk - plantera skog 250 000 hektar, och återväta 100 000 hektar - samt att införa skatt på mark med stora koldioxidutsläpp över en viss nivå, för att sätta press på att dessa marker tas ur bruk.
- Det råder politisk enighet i Danmark kring dessa åtgärder. En modell har utvecklats för att värdera mark där staten köper gårdar som är till salu för att kunna använda dessa i markbyten vid genomförandet av åtgärder. Markens värde fastställs genom samarbete mellan grupper av olika intressenter. Modellen syftar till att säkerställa att åtgärder genomförs på de mest lämpliga platserna och att markägare får rätt nivå på ersättning
- Deltagare tog upp skillnader mellan Sverige och Danmark -Sverige verkar ha fokus på ekonomisk rationalitet på enskilda företag och skiften, vilket innebär att effektivisera för enskilda syften. Ett mer holistiskt perspektiv, som beaktar hela landskapet och ekosystemtjänster, som i Danmark upplevs som en utmaning att integrera i nuvarande system.
- Det lyftes fram att danska jordbrukare ofta är mer flexibla när det gäller att flytta till en annan gård vid behov. I Sverige är det däremot vanligt att gårdar stannar i familjen i flera generationer, vilket gör flytt mindre tänkbart.

Enköpings kommun (CTB)

- Samverkansprojekt mellan Enköping och Heby kommuner - Enköping och Heby driver tillsammans ett projekt för den del av Örsundaån som berör båda kommunerna. Projektet har fått stöd från LOVA och har som mål att identifiera åtgärder för att minska övergödningen i området.

- Karta och åtgärdsförslag - En konsult har tagit fram en karta som visar olika åtgärder för att minska övergödningen, inklusive:
 - o Platser där våtmarker kan anläggas.
 - o Möjligheter att restaurera tidigare åtgärder.
 - o Områden där diken kan pluggas.
- En lista med åtgärder har tagits fram och klassificerats enligt enklare åtgärder som endast kräver en markägare, ofta på mindre arealer och med mindre påverkan på näringslivet, samt åtgärder som involverar flera fastighetsägare och är svårare att genomföra.
- Totalt finns potential att anlägga 1 500 hektar våtmarker, men det är i praktiken svårare eftersom det finns många andra faktorer att väga in.
- Avsikten är att ta fram ett underlag som en åtgärdssamordnare kan arbeta vidare med.

Heby kommun (MR)

- Utmaningar med ökande vattenflöden - En av de största utmaningarna för Heby kommun är att hantera de ökande vattenflödena.
- Åtgärder och initiativ - Kommunen har tagit fram en plan för hantering av skyfall och höga flöden; genomfört drönarfilmningar för att kartlägga vattendragen, införskaffat egna mätinstrument för att öka kunskapen om vattendragen.
- Samtliga dessa insatser har finansierats av kommunen själv, trots att ingen budget var avsatt för ändamålet.
- Samarbete och dialog - Kommunen har etablerat dialoger med länsstyrelsen, SMHI samt Tierps och Uppsala kommuner och har bildat arbetsgrupper för att diskutera lösningar på översvämningsproblematiken.

Hushållningssällskapet (FW)

- Hushållningssällskapet arbetar med rådgivning kring dränering och markavvattning.
- Dikningsrensning och ägarinformation - Dialogmöten om dikningsrensning har också hållits. Många dikningsföretag är inaktiva, och vissa har inte haft styrelsemöten sedan 1950- eller 1960-talet. Tar tid att bara samla in den informationen om vem som är ägare i ett dikningsföretag.

Avslut

- Dagens sista programpunkt workshop ströks då diskussioner istället fördes kontinuerligt under dagen i anslutning till de olika presentationerna.
- Tackade för dagen. Vikten av samsarbetsformer mellan myndigheter och markägare påpekades.

- Deltagare tog upp att Länsstyrelsen gått alltmer till tillsynsrollen, vissa önskade mer vägledning och organisering kring åtgärder. Det lyftes att Länsstyrelsen vill ha en mer vägledande roll men finns en del kvar att göra med internsamordningen. Finns fokus på det nästa år, speciellt ang. Vattenmyndighetens åtgärdsprogram, men det är svårt att kombinera de olika rollerna som Länsstyrelsen har.
- Deltagare lyfte att sådana här tillfällen är en viktig ingång till forskningen för kommuner och lantbrukare - dagen var uppskattad.
- Enköping nämnde att de planerar för en uppföljning när deras konsult har levererat slutprodukten av förslaget på platser för våtmarker etc., främst för politik och förvaltning, men de bjuder gärna också in dagens deltagare. De lyfte även att man har ett stort antal åtgärder runt om i kommunen så de är gärna värd för en fältdag om SLU är intresserade.
- Förra årets Vattenkonferens i Heby som anordnades av Örsundaåns vattenråd var även uppskattad och man har haft idéer om att följa upp med en till sådan dag i framtiden.

2nd regional meeting with stakeholders in Finland - NORDBALT-ECOSAFE project



Mikä on mielestäsi hyväksyttävä
pöytävarmuus vedenlaadun määrittämiselle
kesientilan arvioinnissa?



Hyväksytään 50% pöytävarmuus on
vähintään 50% veden laadun arvio

Hyväksytään 22% pöytävarmuus on
vähintään 20%

Hyväksytään 5% pöytävarmuus on
vähintään 10%



Tyrnävän työpaja 14.10

Nimi	Organisaatio	Participates (Yes/no)	Task	E-mail
1 Hannu Marttila	OY	Yes <input checked="" type="checkbox"/> <i>HMM</i>	tutkija	hannu.marttila@o-y.fi
2 Seppo Hellsten	Syke	Yes		
3 Jukka Aroviita	Syke	Yes <i>Jukka Aroviita</i>	tutkija	jukka.aroviita@syke.fi
4 Pasi Valkama	Syke	Yes <input checked="" type="checkbox"/>	tutkija	Pasi.Valkama@syke.fi
5 Katri Rankinen	Syke	Yes <input checked="" type="checkbox"/>	tutkija	Katri.rankinen@syke.fi
Anu Lähteenmäki	Syke	Yes <i>Anu Lähteenmäki</i>	tutkija	anu.lahtenmaki@syke.fi
6 Uutela	Syke			
7 Eerika Albrecht	Syke	Yes <i>Eerika Albrecht</i>		
8 Riina Rahkila	Proagria	yes <i>Riina Rahkila</i>	National agricultural advisory organisation	riina.rahkila@proagriafin.fi
9 Marika Sohlo	Proagria		National agricultural advisory organisation	
10 Risto Jokela	Proagria		National agricultural advisory organisation	
11 Ville Koukkari	Metsäkeskus		National forestry advisory organisation	
12 Hanna Marttinen	Tyrnävän maaseututoimisto	Yes <i>Hanna Marttinen</i>	Municipal agriculture office	hanna.marttinen@tyrnava.fi
13 Jonna Roininen	Tyrnävän maaseututoimisto	Yes <i>Jonna Roininen</i>	Municipal agriculture office	jonna.roininen@tyrnava.fi
14 Ari Kauppi	Tyrnävän maaseututoimisto	Yes <i>Ari Kauppi</i>	Municipal agriculture office	ari.kauppi@tyrnava.fi
15 Ilkka Matinoli	viljelijä ja vesialueen omistaja		Farmer	
16 Janne Matinlauri	viljelijä		Farmer	
17 Samuli Juntila	viljelijä		Farmer	
18 Joy Bhattacharjee	OY	<i>Joy Bhattacharjee</i>	Researcher	joy.bhattacharjee@o-y.fi
19 Mats Willner	South-Ostrobothnia Ely-Centre	<i>Mats Willner</i>	National coordinator of Gypsum project	mats.willner@ely-keskus.fi
20 Markus Saari	North-Ostrobothnia Ely-Centre	yes	Regional environmental administration	



North-
Ostrobothnia Ely-
Centre

21 Anne-Mari Rytönen

22 Kaisa-Leena Huttunen

23 Risto Heinola

24 ANU KANKAALA

25. Vuokko Klaukka

SPK Oy

mi

	Regional environmental administration	
Yes <input checked="" type="checkbox"/>	tutkija	Kaisa-Leena huttunen@syste
Yes <input checked="" type="checkbox"/>	kehityskoordinaattori	anu.kankaala@spk
<input checked="" type="checkbox"/>		

Duokan Alabari



Funded by the
European Union

This project has received funding from the European Union's Horizon Europe research and innovation programme under Grant Agreement No. 101060020



NORDBALT-ECOSAFE SIDOSRYHMÄTILAISUUS

14.10.2024, Tyrnävä, Hannuksen piilopirtti



Ohjelma

- › **9:30** **KAHVIT**
- › **10:00** **Tilaisuuden avaus, NORDBALT-ECOSAFE hankkeen terveiset**
 - › Prof. Brian Kronvang Århusin yliopisto, Tanska
- › **10:10** **Maatalous osana valuma-aluelähtöistä vesienhallintaa**
 - › Markus Saari, Pohjois-Pohjanmaan elinkeino-, liikenne- ja ympäristökeskus
- › **10:30** **Maaseututoimen ajankohtaiset kuulumiset**
 - › Hanna Marttinen, Tyrnävän maaseutupalvelut
- › **NORDBALT-ECOSAFE työpakettien kuulumiset**
- › **10:50** **Millaisia ovat vesien hyvän tilan kriteerit?**
 - › Jukka Aroviita, Suomen ympäristökeskus
- › **11:10** **Jatkuvatoimisen mittauksen käytänteitä ja kuulumisia**
 - › Pasi Valkama, Suomen ympäristökeskus
- › **11:30** **Miten ravinnesuhteet muuttuvat?**
 - › Katri Rankinen, Suomen ympäristökeskus

Ohjelma

- › **11:45 LOUNAS**
- › **12:50 Mallintamalla lisää tietoa ravinnekuormasta**
- › Hannu Marttila, Oulun yliopisto
- › **13:10 Luontopohjaiset ratkaisut ja toimet**
- › Pasi Valkama, Suomen ympäristökeskus
- › **13:30 Millaisia ohjauskeinoja tarvitaan parantamaan vesien tilaa?**
- › Anu Lähteenmäki-Uutela
- › **13:45 KAHVIT**
- › **14:00 Vedet haltuun valuma-alueilla – esimerkkinä Utajärven ilmastokosteikko**
- › Riina Rahkila, Pro Agria
- › **14:20 Pienryhmäkeskustelut**
- › Millaisia toimia ja vesiensuojelurakenteita tarvitaan?
- › **14:35 Loppukeskustelu**
- ›

Seppo nyt



Millaisia ovat vesien hyvän tilan kriteerit?

Nordbalt Ecosafe EU-projektin sidosryhmätilaisuus

Hannuksen Piilopirtti, Tyrnävä, 13.10.2024

Jukka Aroviita, Syke

Lähtökohdat

Tilan arviointi ja sen luokittelu on ihmisten toiminnan aiheuttamien ekologisten muutosten voimakkuuden arviointia.

Vesipuitedirektiivi (VPD): Tavoite on hyvä ekologinen tila:

- Hyvän ekologisen tilan luokassa biologisten laatutekijöiden arvoissa on merkkejä ihmistoiminnasta johtuvista vähäisistä muutoksista, mutta ne saavat erota ainoastaan vähän vertailuarvoista.
- Fysikaalis-kemialliset laatutekijät eivät ylitä tasoja, jotka varmistavat biologisten laatutekijöiden hyvän tilan saavuttamisen (vesistötyypille ominainen ekosysteemin toiminta).
- Hydrologis-morfologiset olot eivät haittaa biologisten laatutekijöiden hyvän tilan saavuttamista.

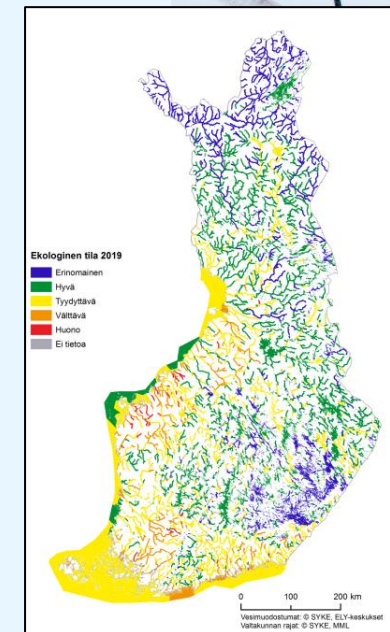

Vertailuolujen ja luokkarajojen määrittely

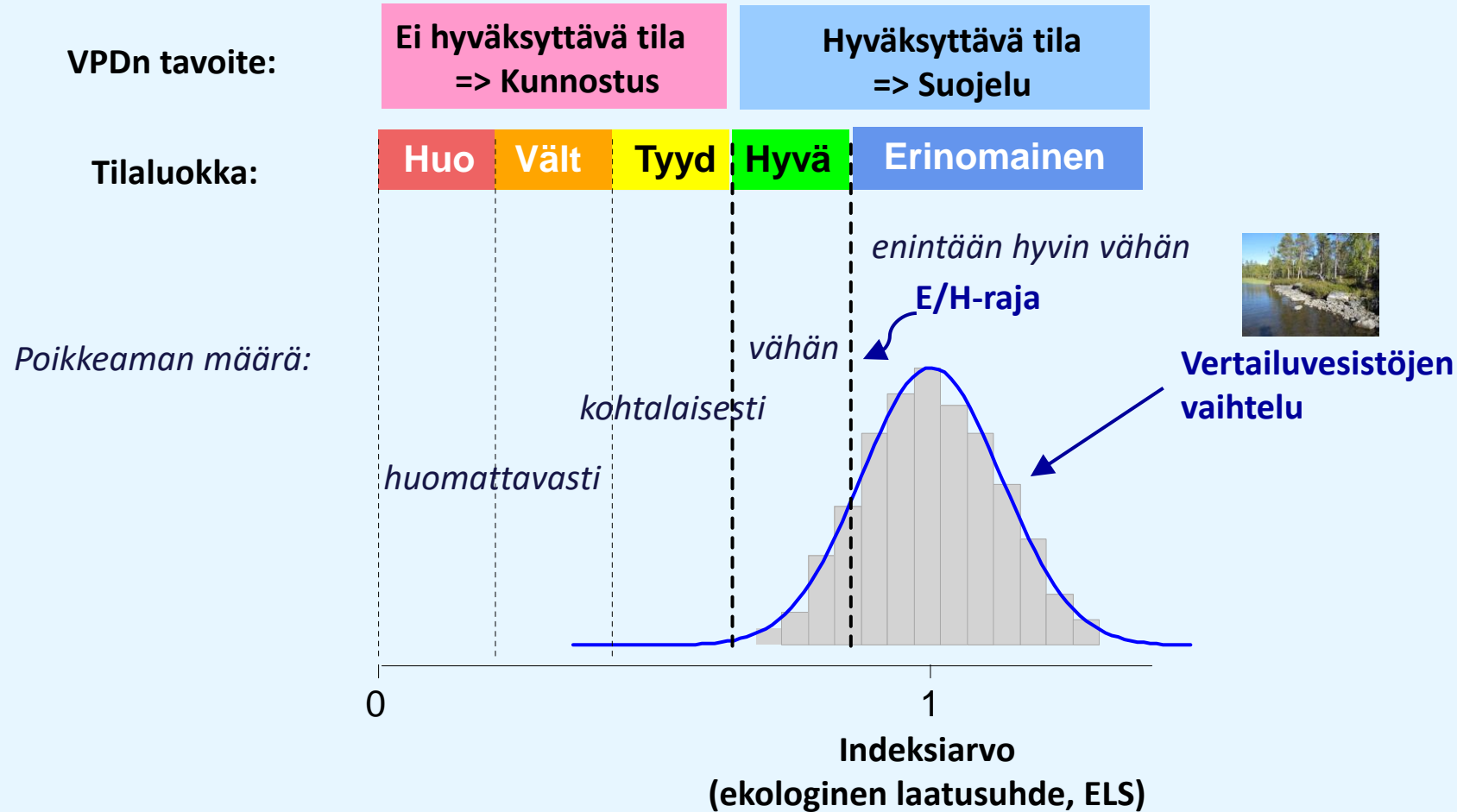

Luotettavan luokittelujärjestelmän kannalta keskeistä on määrittellä vertailuolot ja -arvot mahdollisimman tarkasti sekä pystyä hallitsemaan luontainen vaihtelu mahdollisimman hyvin, jotta tilan heikentymistä pystytään arvioimaan koko skaalalla.

Biologiset laatutekijät

Kasviplankton



Kuva: Sari Mitikka

Pohjaeläimet



Kuva: Vasco Elbrecht

Kalasto



Kuvat: Jukka Ruuhijärvi ja
Kati Martinmäki-Aulaskari

Vesikasvit ja päällykslevät



Kuva: Minna Kuoppala ja Satu Maaria Karjalainen

VPD lisännyt biologisen seurantatiedon määrää

Joet

Vesimuodostumien lukumäärä mistä näytteenottoja

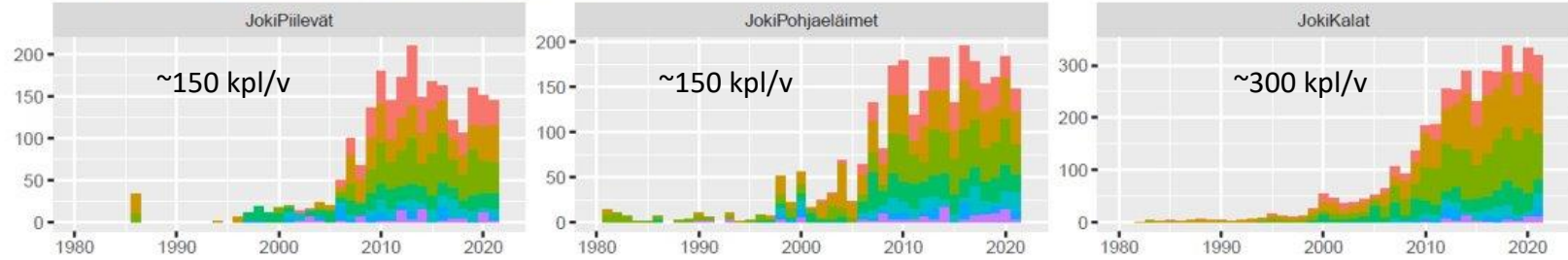

Järvet

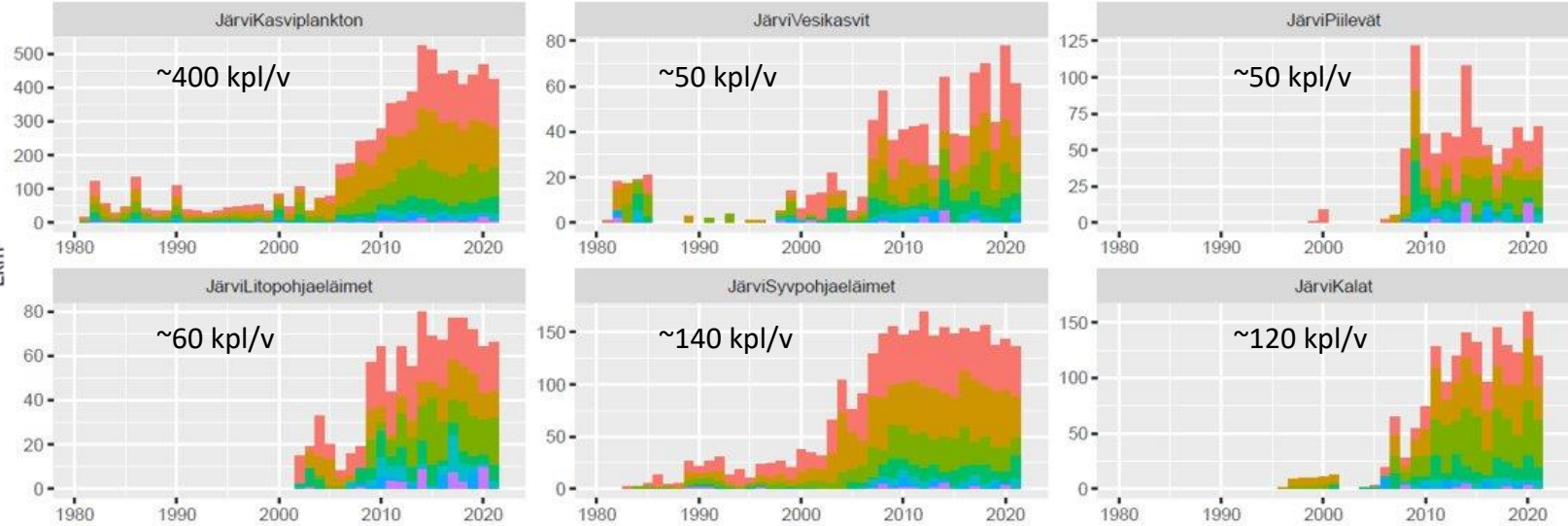

Rannikko

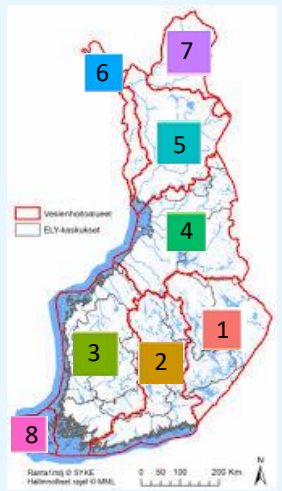
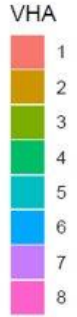
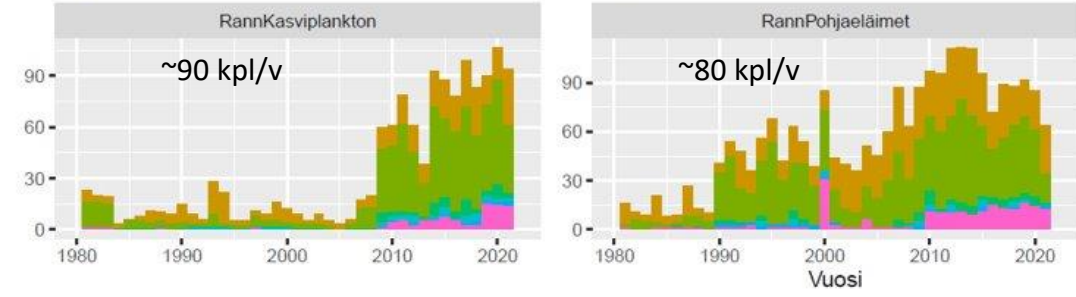

Vain osasta 6822 vesimuodostumasta on laajat seuranta-aineistot

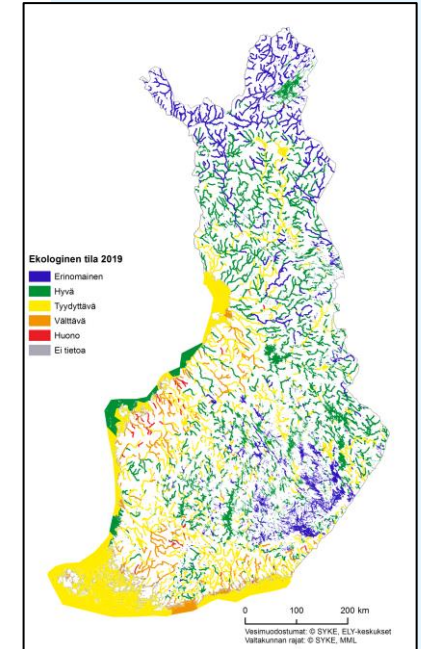
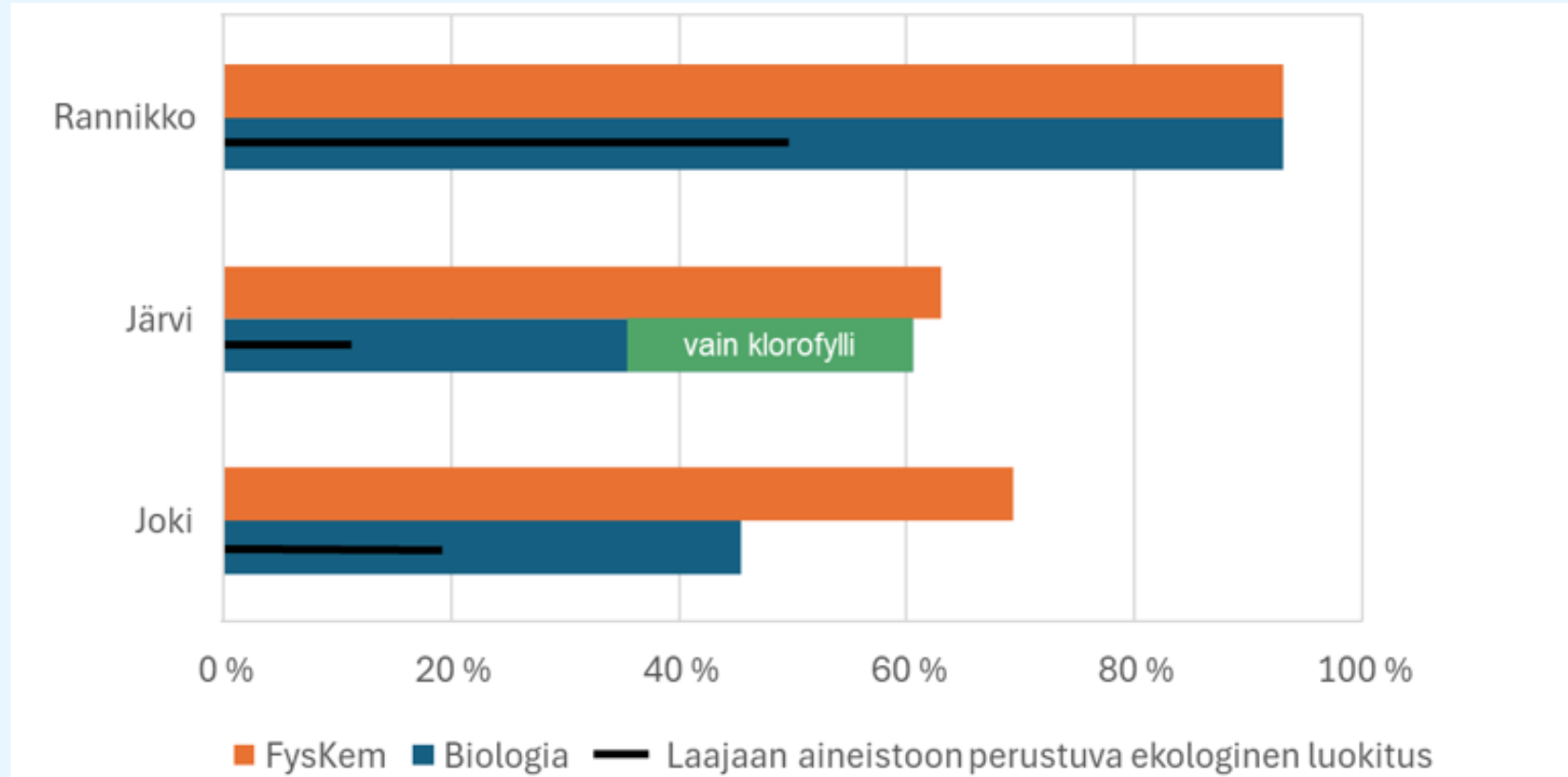

Kuva. Vesimuodostumien osuus, joista oli käytössä fysikaalis-kemiallisen tilan ja biologisen tilan seuranta-aineistoja vesienhoidon 3. luokittelussa (lähde vhs3 PowerBi-raportti).

Tietoisku: Käynnistymässä vesienhoidon 4. kierroksen tilaluokittelu, työ ELY-keskuksissa 2024-2025

- Uusi opasluonnos oli laajalla sidosryhmäkommenttikierroksella syksyllä
- Vesimuodostumat ja niiden tyypittelyä on tarkistettu
- Seurantapaikkatasosta luovutaan
- Uusia ja tarkennettuja biologisen tilan arvioita: Jokien vesikasvillisuus, Rr-järvien kasviplankton ja rannikon punaleväindikaattori, syvänteide pohjaeläimistön vertailuolot)
- Heikoimman tekijän (One-out, all-out) periaate otetaan käyttöön vesimuodostuman ekologisen tilan määräytymisessä
- Kaukokartoituksen ja mallinnetun tilan hyödyntämistä lisätään edelleen
- Tiedon hallintaa on kehitetty ja kehitetään (mm. havaintopaikat, Pisara-tietojärjestelmä)



Vesimuodostumien ekologisen tilan luokitusäännöt

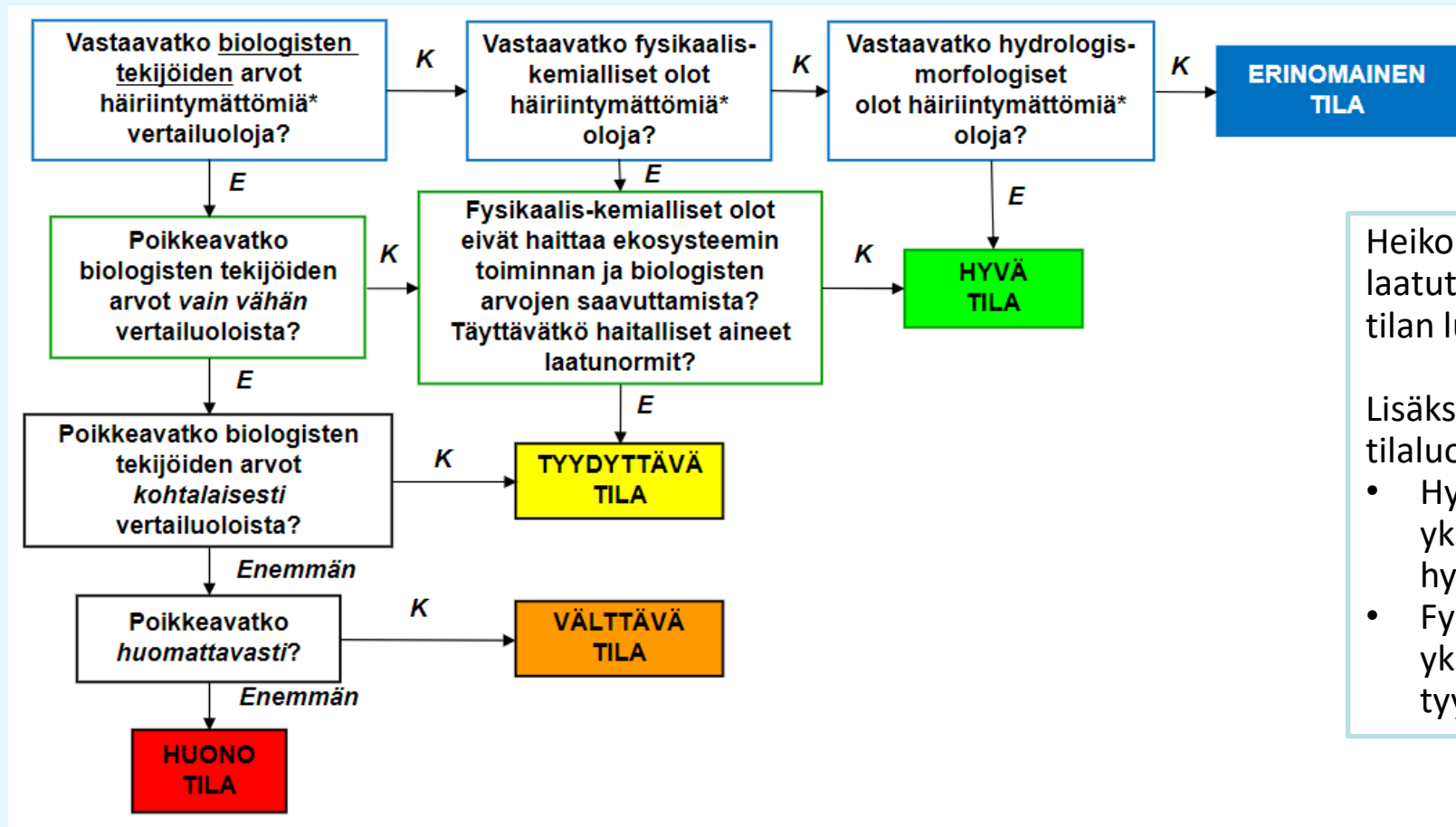

Heikoimmassa tilaluokassa oleva biologinen laatu-tekijä määrää vesimuodostuman ekologisen tilan luokan

Lisäksi, jos tukevat tekijät ovat erinomaista tilaluokkaa heikommassa tilassa:

- Hydro-morfologiset laatu-tekijät voivat yksistään laskea tilaluokkaa erinomaisesta hyvään
- Fysikaalis-kemialliset laatu-tekijät voivat yksistään laskea tilaluokan hyvään tai tyydyttävään

Kuva. Ekologisen tilan luokittelun lohkokaavio. K=Kyllä, E=Ei. *Erinomaisen tilan luokassa arvojen tulee vastata täysin tai lähes täysin häiriintymättömiä olosuhteita. Kaavio on suomennettu vesipuitelidirektiivin yleisestä metodiohjeistuksesta (Euroopan yhteisö 2003).

Mitä teemme tässä projektissa?

Työpaketti 1 keskeiset kysymykset:

1. Miten ravinteiden vertailuarvot ja luokkarajat vaihtelevat eri maissa ja eri tyyppisissä vesistöissä?
2. Millaisia ovat ekologisesti turvalliset ravinnerajat nykytilassa?
3. Vaatiiko ilmastonmuutos turvallisten rajojen tarkentamista?

Ekologisen tilan ravinnerajoista

- Hyvän tilaluokan ravinnerajat tulee olla sillä tasolla että ne turvaavan hyvän biologisen tilan toteutumisen
- Ravinnerajat kuitenkin määritelty VPD-työn alkuvaiheessa eikä niitä ole kattavasti validoitu



Liite 7.4. Vedenlaatu

Jokien vedenlaadun vertailuolot ja luokkarajat.

Tyyppi	Muuttuja	Kausi	Yksikkö	Vertailuolot	Luokkarajat			
					E/Hy	Hy/T	T/V	V/Hu
Kt Keskisuuret turvemaiden joet	kok. P	vuosi	µg/l	<20	20	40	60	90
	kok. N	vuosi	µg/l	<450	450	900	1500	2500
	pH-minimi	vuosi		>5,7	5,7	5,5	5,0	4,8
Kk Keskisuuret kangasmaiden joet	kok. P	vuosi	µg/l	<15	15	35	55	85
	kok. N	vuosi	µg/l	<335	335	800	1400	2400
	pH-minimi	vuosi		>5,8	5,8	5,6	5,1	4,9

Jäsenmaiden välinen rajojen vertailu

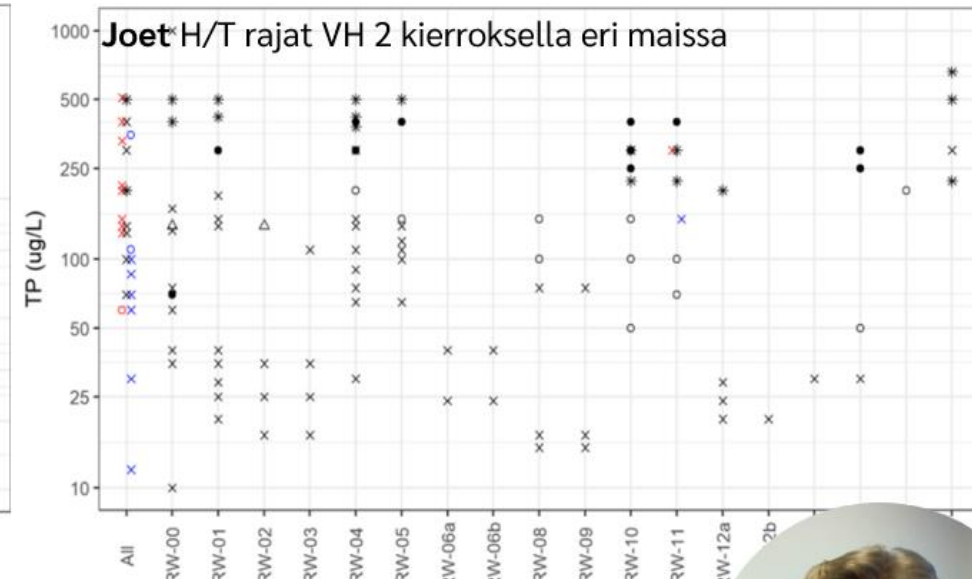
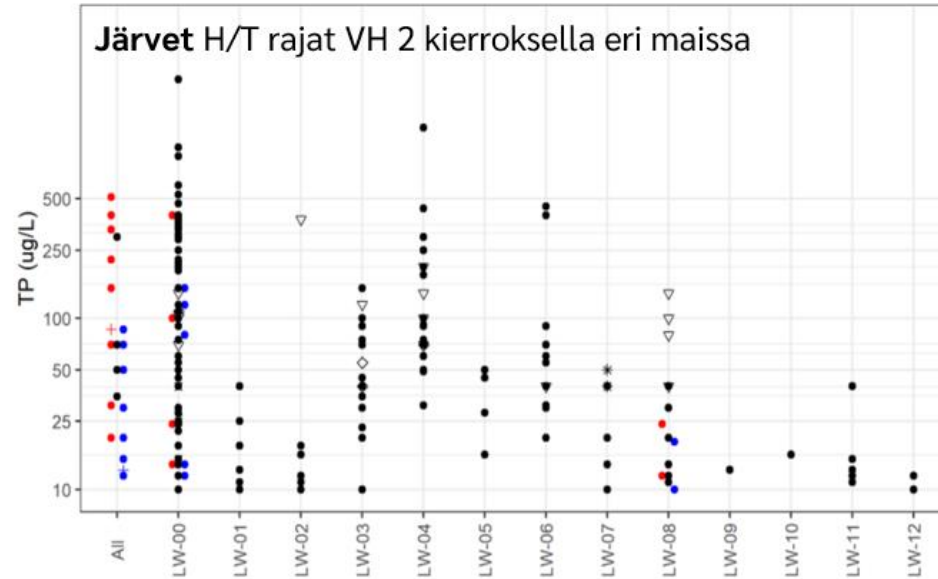

Turvaavatko kaikki nämä rajat hyvän biologisen tilan?

NIA



Tilastollinen testi ravinnerajojen validoimiseksi

- Validoitu nykyisiä ravinteiden H/T-tilan raja-arvoja ravinteet ja biologian (ELS-arvot) yhdistävillä regressiomalleilla
- Biologisen tilan ELS-arvot muunnetaan hyvän tilan saavuttamisen todennäköisyyksi
- Metodi mahdollistaa fosforipitoisuuksien ja ELS-arvojen eroavaisuuksien tasapainottamisen
- Metodia suosittelee EU komission VPDn toimeenpanoa ohjaava ECOSTAT-ryhmä (CIS-Best Practice guidance v. 2, 2024)
- Phillips ym. 2023: <https://doi.org/10.1016/j.scitotenv.2023.168872>
- Sovellus-työkalupakki: https://shiny.freshwater-ecology.com/Tkit_NEW/

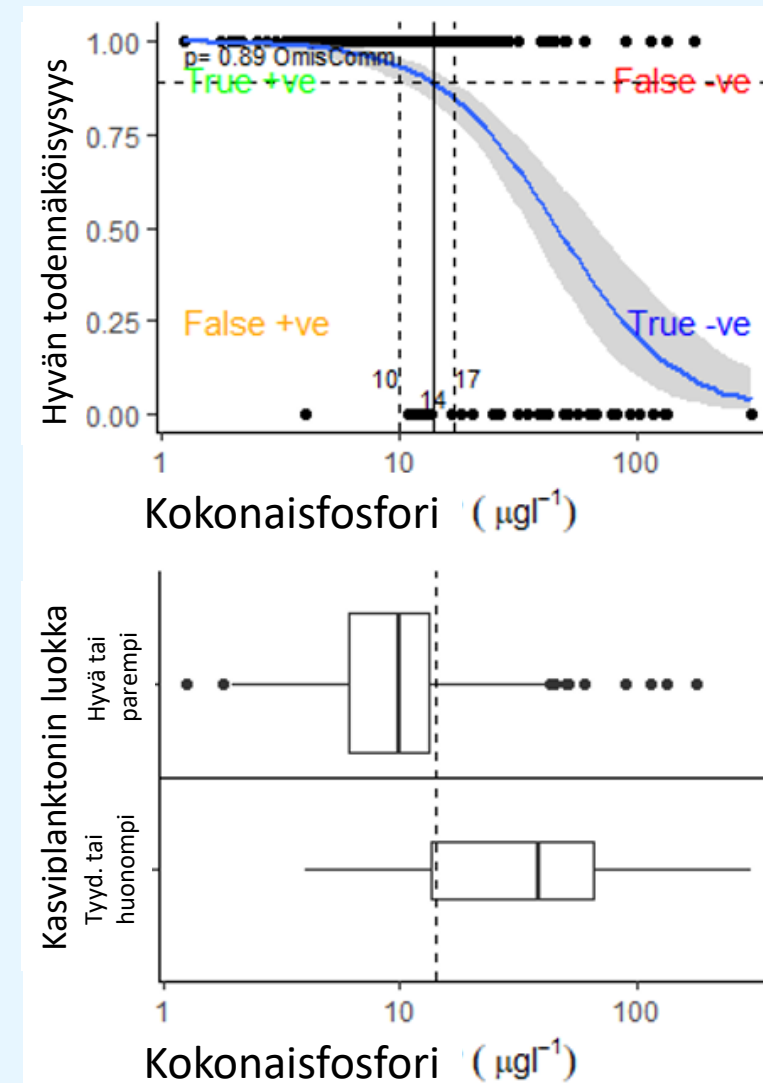

Pohjoismaiden H/T-ravinnerajojen vertailun tulokset

BLR results and comparison with current GM boundaries: Nordic region total Phosphorus in Rivers

Total Phosphorus ($\mu\text{g L}^{-1}$)

Nordic region

Lowland types

NGIG type	R-N1	R-N3	R-N4	Clay rivers	
Type description	moderate alkalinity, non-humic, small	low alkalinity, humic, small-medium	moderate alkalinity, non-humic, medium	clay cover mean 40% (20-70%)	
BQE used for modelling	Phytobenthos	Phytobenthos	Phytobenthos	Benthic inverts	
mean	17	31	24	45	
conf. limits	12-24	26-36	18-33	33-60	
modelled GM boundaries	r2	0.53	0.35	0.11	0.27
prob good	0.76	0.73	0.86	0.40	
N (# WBs)	143	442	96	135	
current GM boundaries	NO	25	24	25	40-80
	SE	21 ¹	20-23	20	na
	FI	35	40	35	na

¹ Includes larger and mid-altitude rivers

Current boundaries in yellow need validation with ECOSTAT toolkit (Shiny App)



Yhteenveto

Ravinnerajat keskeisiä hyvän ekologisen tilan saavuttamisen työkaluja

Määrittely on vaikeaa, sillä useimmilla biologisilla tekijöillä ei ole suoraa suhdetta ravinnepitoisuuksiin. Lisäksi kokonaisravinteet eivät aina kuvaa käyttökelpoisten ravinteiden määrää

EU:ssa Suomen asettamat ravinnerajat sisävesille sijoittuvat selvästi matalampien pitoisuuksien joukkoon, mutta saattavat vaatia tarkentamista

Valuma-alueille raja-arvot tulee muuntaa hyvän tilan mahdollistamiksi ravinnekuormiksi



Kuva: Jaana Rääpysjärvi

Vedenlaadun sensorimittaukset

1. Yksittäisiin vesinäytteisiin perustuva epävarmuus? Mikä on hyväksyttävä tarkkuus?
2. Mitä hyötyä näet avoimesti esitettävällä sensoridatalla ?



Vedenlaadun sensorimittaukset Kokemuksia Pohjois-Euroopan virtavesistä

Muutokset maankäytössä sekä ilmastomuutos vaikuttavat vesivaroihimme monin tavoin ja voivat johtaa ravinteiden liialliseen kertymiseen vesistöihin (rehvittyminen), kiintoainekuormituksen lisääntymiseen ja muuhun pilaantumiseen (esim. raskasmetallit, orgaaniset haitte-aineet ja muut vaaralliset aineet). Näin ollen on yhä tärkeämpää seurata ihmistoiminnan sekä kuormitusta vähentävien toimenpiteiden vaikutuksia vedenlaatuun. Vedenlaatu erityisesti virtavesissä voi vaihdella hyvin nopeasti. Jos tieto virtavesien vedenlaadusta perustuu kuukausittain, kahdesti viikossa tai viikoittain otettuihin vesinäytteisiin, ei vedenlaadun vaihtelusta saada todellista kuvaa. Tähän haasteeseen sensorit voivat tarjota ratkaisun, koska niillä vedenlaatu voidaan seurata huomattavasti tiheämmin. Näin on mahdollista saada tietoa lähes reaaliajassa suhteellisen alhaisin kustannuksin. Tässä politiikkasuosituksessa annamme pääasiassa vesiensuojelun ja vesienhoidon parissa työskenteleville

Vedenlaadun seuranta vesientilan ja muutosten arvioimiseksi on yhä tärkeämpää, koska ihmisen toiminta vaikuttaa vesivaroihimme merkittävästi. Veden laadun heikkeneminen voi vaikuttaa laajalti koko yhteiskuntaan, koska olemme riippuvaisia puhtaasta vedestä kotitalouksissa, kasteluvetä, teollisuudessa, virkistyskäytössä sekä terveyden elinympäristöjen puuroon, järveen, pohjavesikaivoihin tai rannikkovesiin ja seurata useita muuttujia säännöllisesti ja lähes reaaliajassa.

Tämä suositus on suunnattu vedenlaadun ja vesienhoidon parissa työskenteleville henkilöille, jotka käsittelevät veden laatua paikallisella, alueellisella ja kansallisella tasolla.

Olemme koonneet tietoa sensoreiden käyttökokemuksista Pohjois-Euroopan maiden tutkijoilta ja asiantuntijoilta. Olemme haastelleet eri tason sidosryhmiä heidän näkemyksiään vedenlaatusensoreista. Esittelemme myös, miten antureita voidaan käyttää tutkimuksessa. Sensoreiden hyötyä ja tutkimusta esitellään [NORDBALT-ECOSAFEn verkkosivulla](#).

Nordbalt-Ecosafe-hankkeessa tutkitaan sensoreilla tehtävän seurannan etuja ja haasteita verrattuna perinteiseen vesinäytteillä ja laboratorioanalyysillä tehtävään seurantaan. Kiinnitämme huomiota myös erityisesti EU:n vesipuitteidirektiivin (VPD) täytäntöönpanon seurantaan. Nordbalt-Ecosafen yhteistyökumppaneita ovat Tanska (hankkeen koordinaointi), Norja, Ruotsi, Suomi, Latvia ja Puola.





Funded by the European Union

This project has received funding from the European Union's Horizon Europe research and innovation programme under Grant Agreement No. 101060020



Vedenlaatua voidaan seurata avoimen on-line –palvelun kautta

Real-time data from seven Nordic streams, shown on the project website: <https://projects.au.dk/nordbalt-ecosafe>

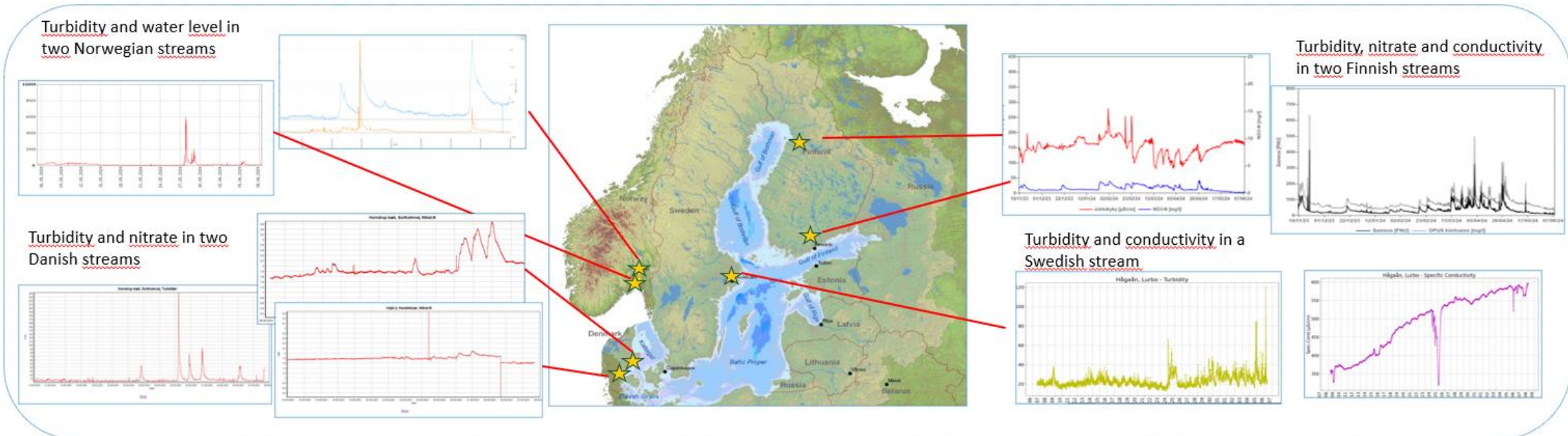

Muista myös: [VESIMITTARI - Vedenlaatu Nyt \(ymparisto.fi\)](http://VESIMITTARI - Vedenlaatu Nyt (ymparisto.fi))



Esimerkki: sensorit havaitsevat suuret pitoisuudet, jotka näytteenotolla jäävät havaitsematta

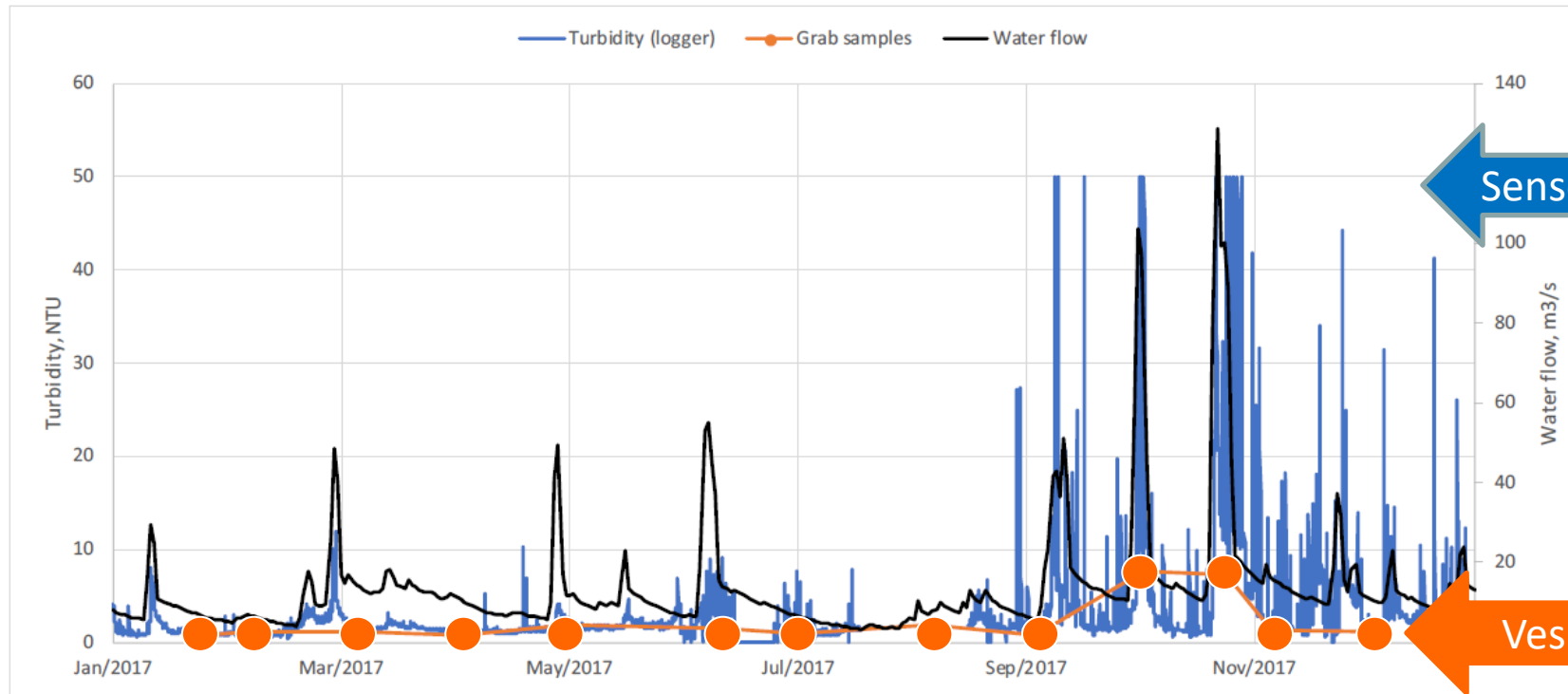

Figure 52. Turbidity and water flow at the outlet of Storelva in 2017. The water flow data are from NVE.

Kaste et al. 2018

Keskipitoisuuden määrittäminen tunnittaisesta sensoridatasta vs. eri näytteenottotiheys:

Simuloidut näytteenottotiheydet: 1/kk, 2/kk, 1/vko (sensoridatasta poimittuna X1000)

- Näytteenotto-ohjelma, jossa näyte voidaan ottaa milloin tahansa (viikonpäivä, kellonaika) näytteenottotiheys huomioiden
 - Realistisempi vaihtoehto, jossa näytteenotto tapahtuu arkipäivänä ma-to virka-aikana
-
- › Sensorin mittaama sameus muunnettiin kokonaisfosforipitoisuudeksi
 - › Tanskassa 1 minuutin välein tehtyjen nitraattityypimittausten hyödyntäminen esimerkkinä

● Näytteenotto kerran kuussa

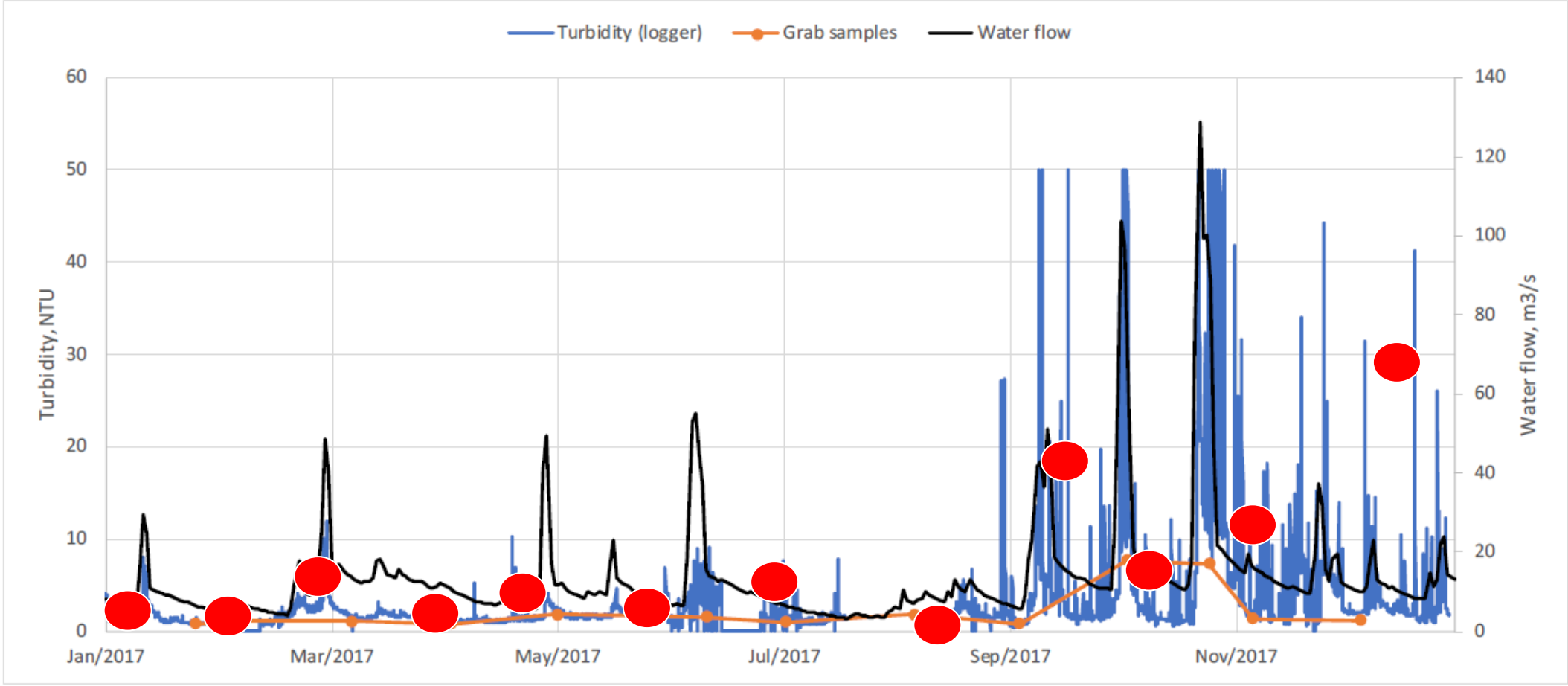

Figure 52. Turbidity and water flow at the outlet of Storelva in 2017. The water flow data are from NVE.

● Näytteenotto kahden viikon välein

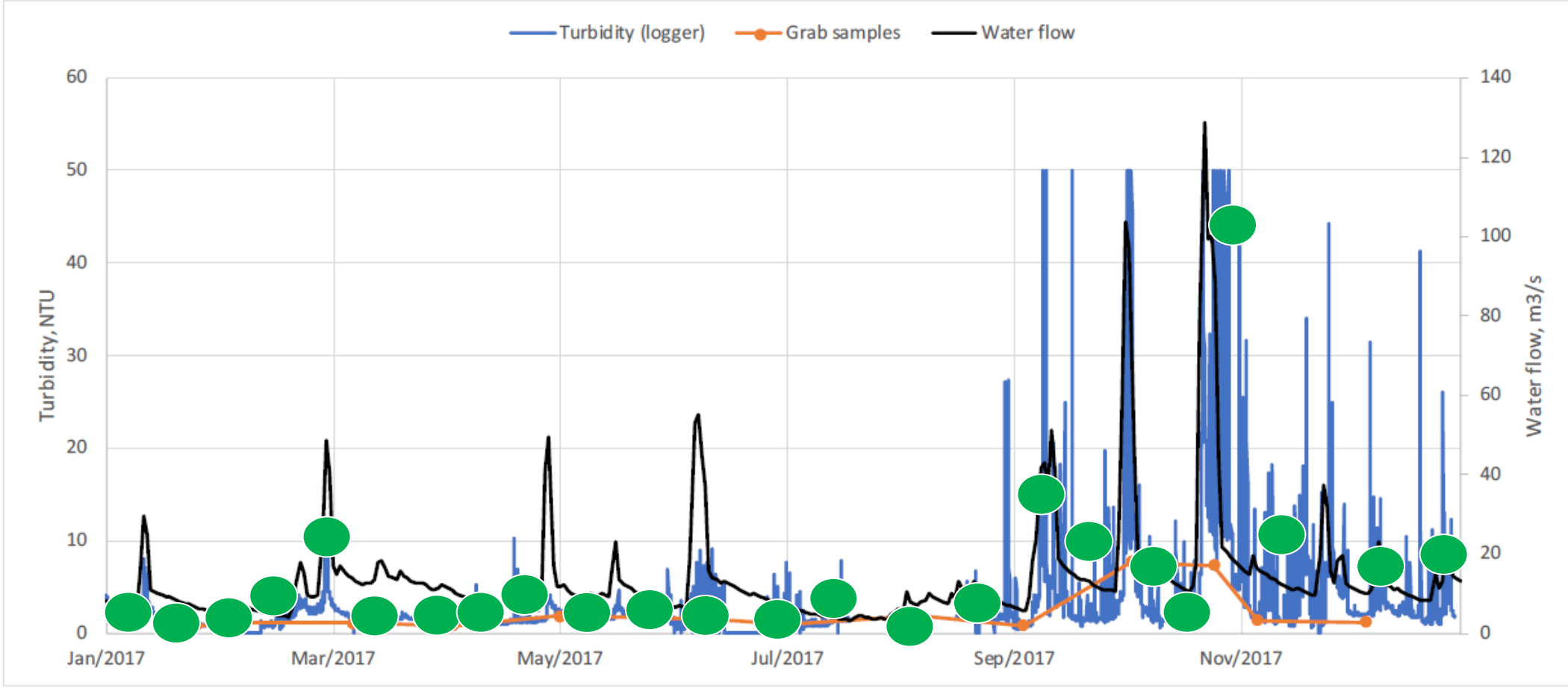

Figure 52. Turbidity and water flow at the outlet of Storelva in 2017. The water flow data are from NVE.

Keskipitoisuuden määrittäminen tunnittaisesta sensoridatasta vs. eri näytteenottotiheys:

- › Tehdään vertailu 8 erilaiselle virtavesikohteelle eri Pohjoismaissa.
- › Tulokset kertovat viikoittaisen, kahden viikon ja kuukausittaisen näytteenottotiheyden epävarmuuden verrattuna tunnittaisiin (tai 1 min) sensorimittauksiin hydrologialtaan erilaisten vuosien (kuiva, sateinen) aikana.
- › Mikä on keskipitoisuus erilaisilla menetelmillä määritettynä?
- › Miten eri menetelmillä tehdyt arviot suhteutuvat vesistön tilan arviointiin käytettävien fys-kem. raja-arvoihin?
- › Mikä on hyväksyttävä epävarmuus?

Esimerkki: pieni savivalentainen joki: vähäsateinen vuosi

1000 kertaa simuloitu näytteenotto eri näytteenottostrategialla

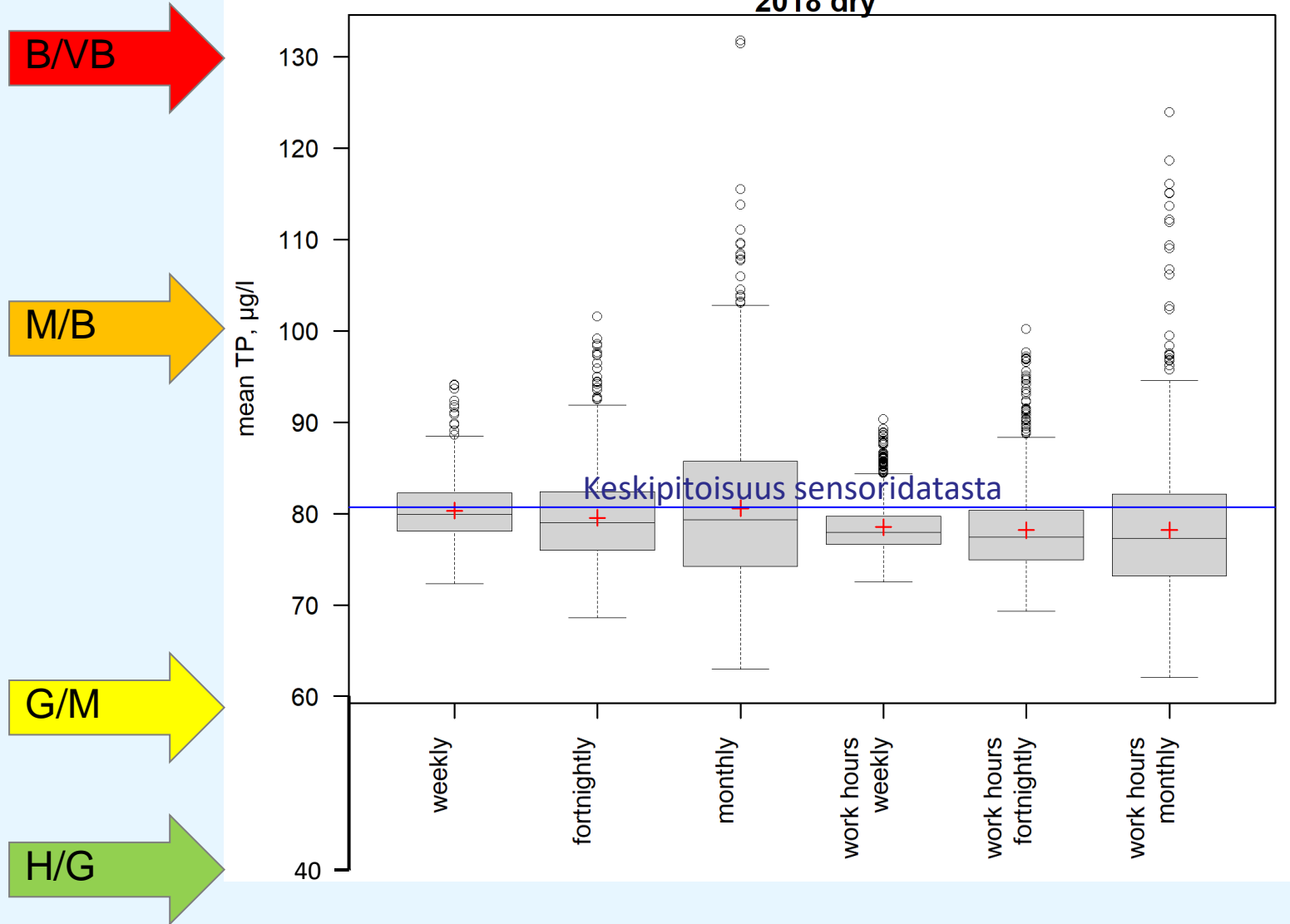

Esimerkki: pieni savivalentainen joki: sateinen vuosi

1000 kertaa simuloitu näytteenotto eri näytteenottostrategialla

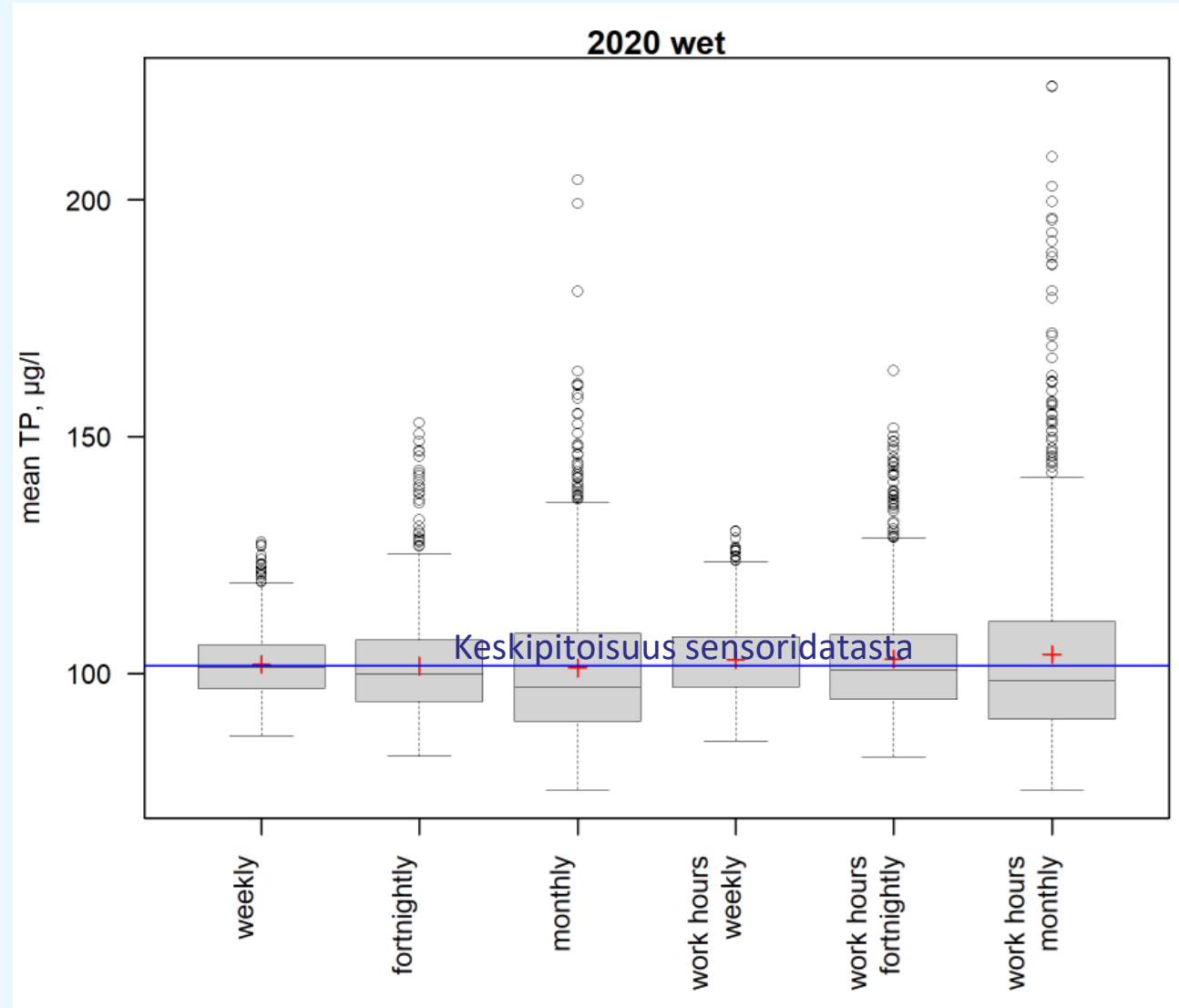
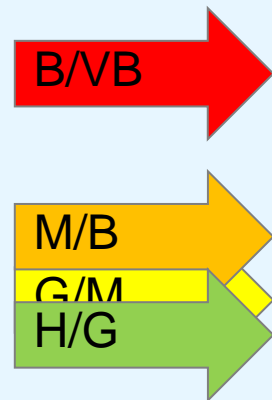

Typpikuorman arviointi eri näytteenottoitiheydellä Horndrup, Tanska

Valuma-alueen koko: 5,48 km²

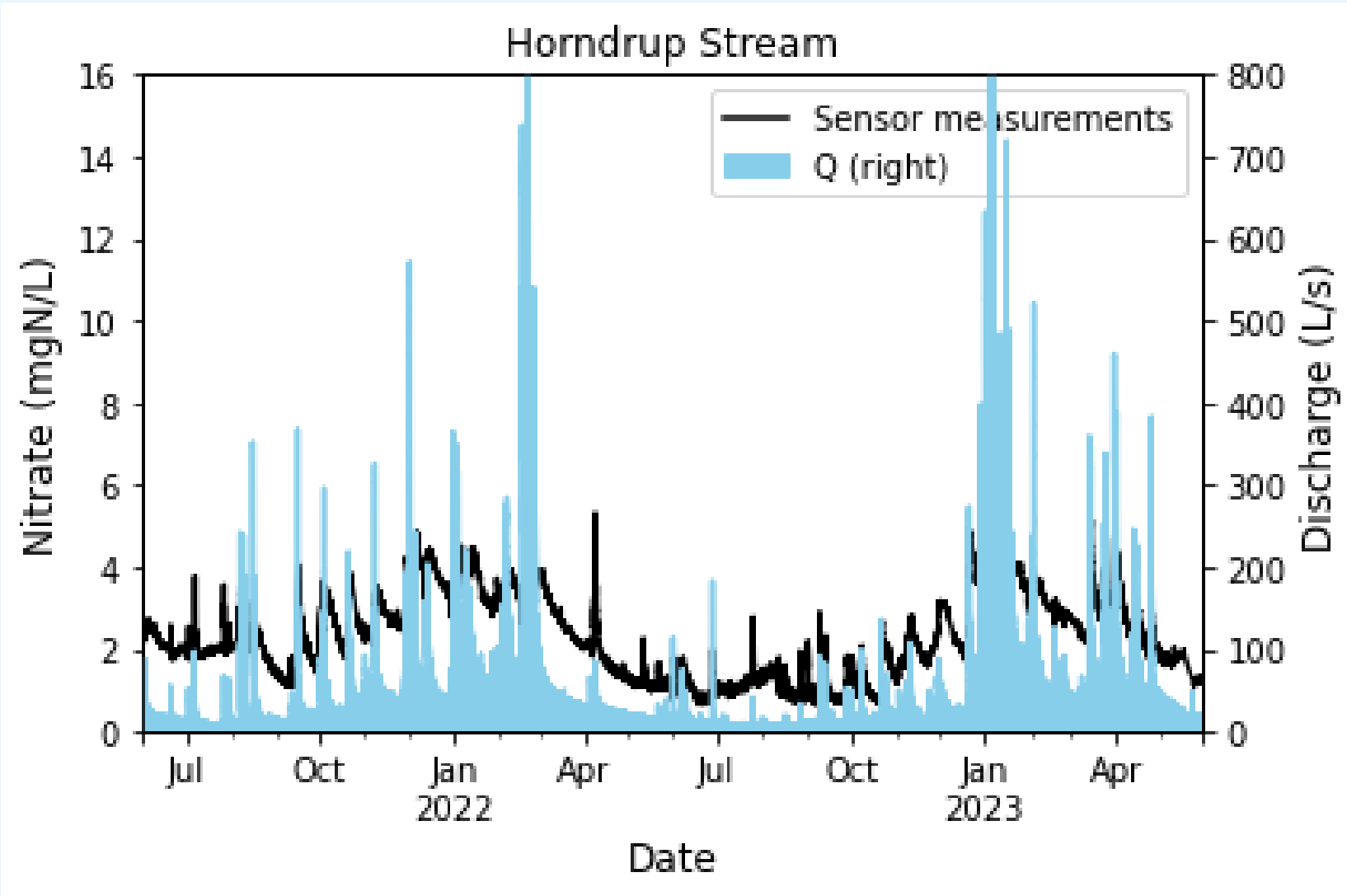

Sample strategy	Number of samples pr year	Hydro. year	Total uncertainty (%)
Day	365	Year 1	0.93
Day	365	Year 2	0.69
1 week	52	Year 1	2.29
1 week	52	Year 2	3.07
2 week	24	Year 1	3.46
2 week	24	Year 2	5.11
18 samples	18	Year 1	3.58
18 samples	18	Year 2	6.16
Month	12	Year 1	5.51
Month	12	Year 2	10.30

From PhD study SENTEM van't Veen et al., 2024 Importance of high-frequency in-situ sensor measurements of nitrogen for accurate monthly and annual load calculations in two small Danish streams (unpublished)

Kuormitusarvion epävarmuus vuosittaiselle typpikuormalle

Perustuu 1000 satunnaisesti valittuun näytteeseen 1 minuutin anturidatasta, viidellä eri näytteenottostrategialla

Horndrup Stream, Denmark; valuma-alueen pinta-ala: 5.48 km²

Negatiiviset arvot tarkoittavat, että näytteenotto aliarvioi todellisen vuosikuormituksen

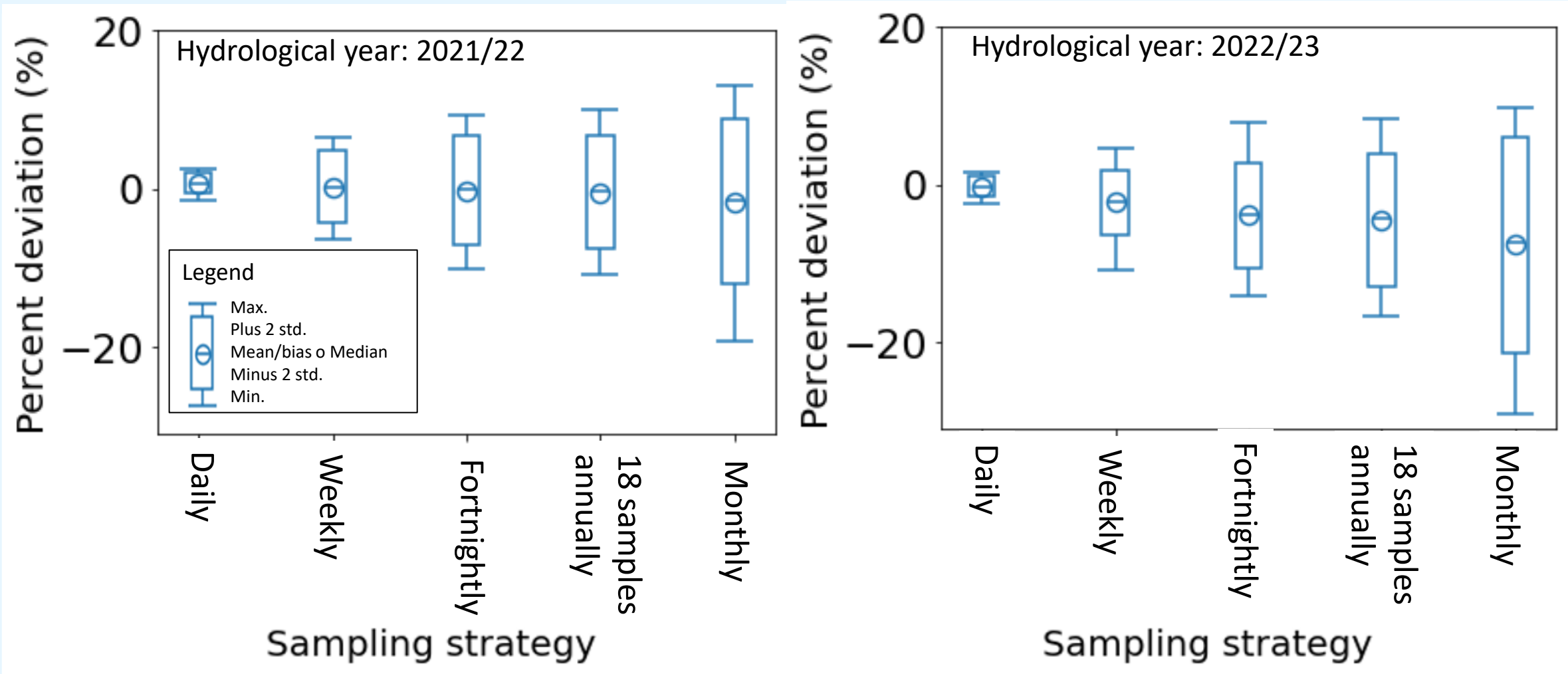

Näytteenottotiheyden vaikutus kuukausittaiseen typpikuormaan

Ylempi kuvaaja: bias -negatiiviset arvot tarkoittavat typpikuorman aliarviota eri näytteenottotiheydellä

Alempi kuvaaja: Typen kuukausikuorman keskihajonta 1000 simuloidun näytteenoton perusteella eri näytteenottotiheyksien mukaisesti

From PhD study SENTEM van't Veen et al., 2024 Importance of high-frequency in-situ sensor measurements of nitrogen for accurate monthly and annual load calculations in two small Danish streams (unpublished)

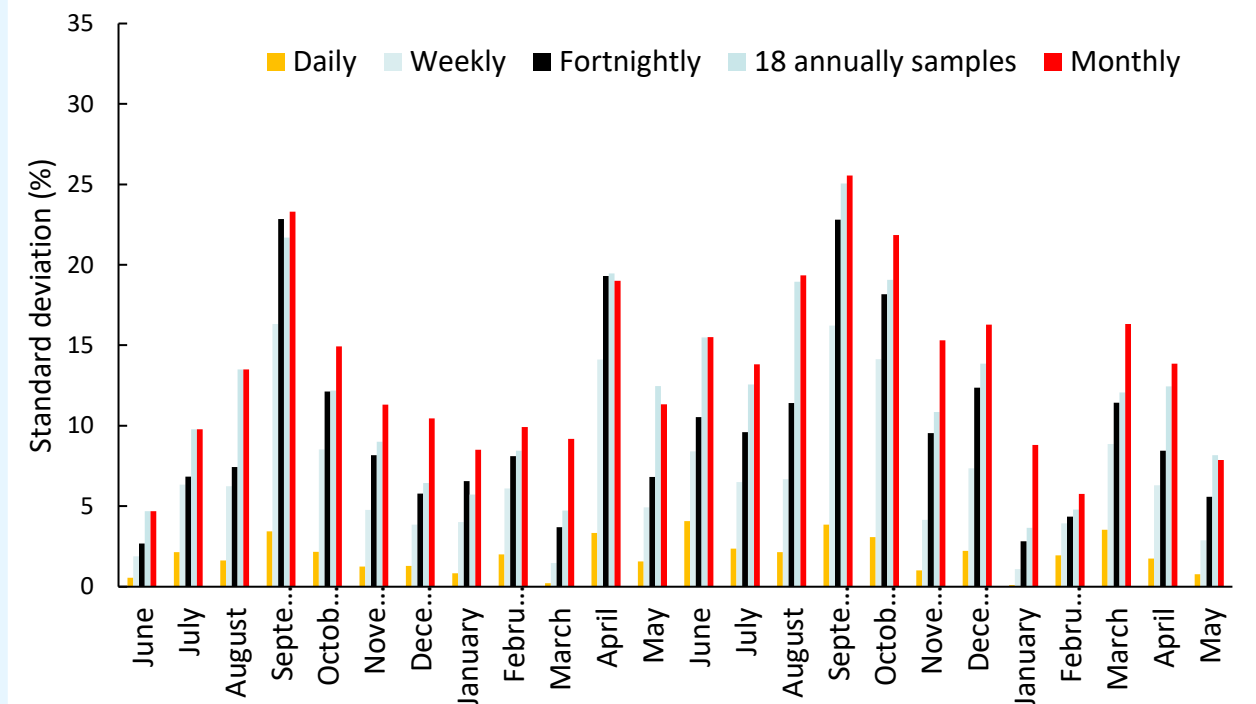
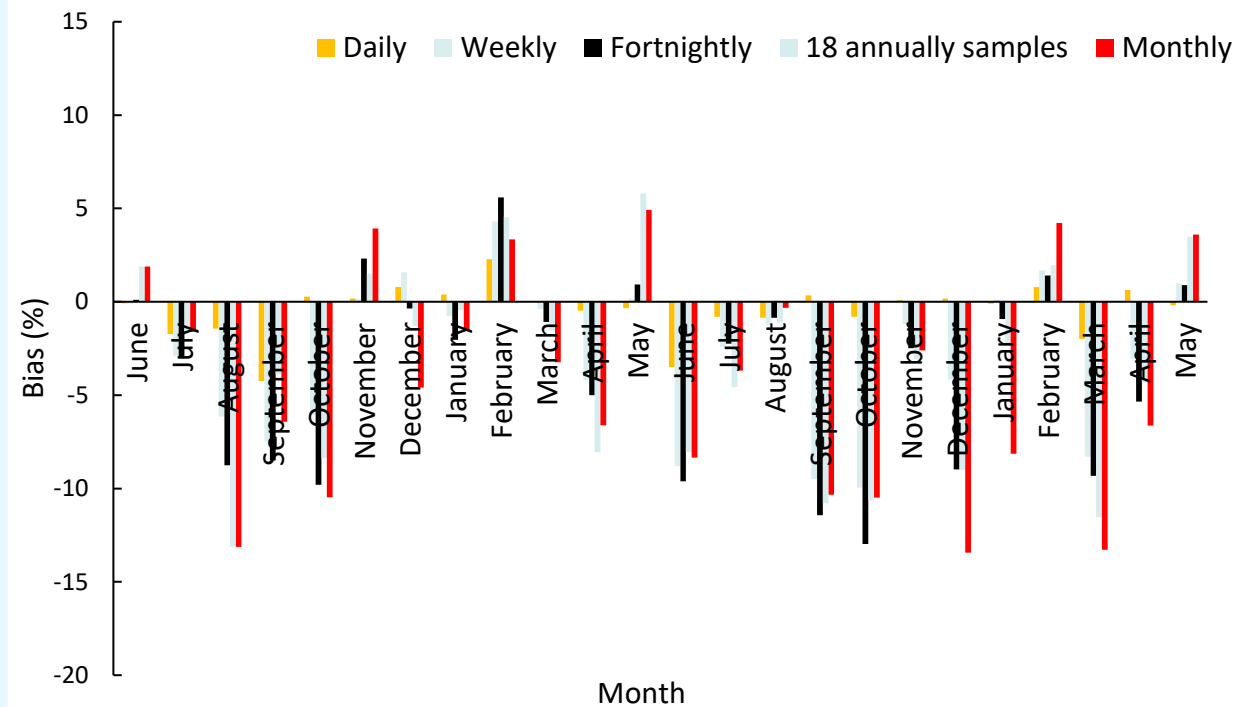

Menti:

- Mikä on mielestäsi hyväksyttävä epävarmuus vedenlaadun määrittämiselle vesientilan arvioinnissa?
 - Hyväksyn sen, että epävarmuutta on vain yhden ja saman luokan sisällä
 - Hyväksyn 20% riskin määrittää tila väärässä luokassa
 - Hyväksyn 50 %:n riskin määrittää tila väärässä luokassa

Menti: join at [menti.com 13863868](https://www.menti.com/join/13863868)

➤ Seuraatko jatkuvatoimisesti mitattua vedenlaatua jostain palvelusta?

- Kyllä, säännöllisesti
- Kyllä, joskus
- Kyllä, 1-2 kertaa
- En koskaan

➤ Jos sensoreilla mitattua reaaliaikaista vedenlaatua pääsisi seuraamaan avoimesta palvelusta, kenelle se erityisesti mielestäsi soveltuisi?

- vesienhoidon parissa työskenteleville
- valtion/kunnan viranomaisille
- viljelijöille ja metsänomistajille
- virkistyskäyttäjille
- vesilaitoksille
- kaikille kansalaisille
- Muille/muuhun tarkoitukseen?

Miten ravinnesuhteet muuttuvat?

WP3:n tuloksia

Nordbalt Ecosafe EU-projektin sidosryhmätilaisuus

Katri Rankinen, Suomen ympäristökeskus

Tummunen ja rehevöityminen

- **Ruskettuminen:** veden värin tummunen valuma-alueelta tulevan humuksen ja liuenneen orgaanisen aineen vuoksi
- **Nuhraantuminen:** hidas rehevöityminen karuissa, kirkaissa tai humuksellisissa järvissä
- **Rehevöityminen:** perustuotannon kasvu ravinnepitoisuuden lisääntymisen vuoksi
- **Ravinnesuhteet muuttuvat**
- **Näkösyvyys pienenee ja pintaveden lämpötila nousee**



Ravinnekuormitukseen vaikuttavia tekijöitä valuma-alueella

NORDBALT
ECOSAFE

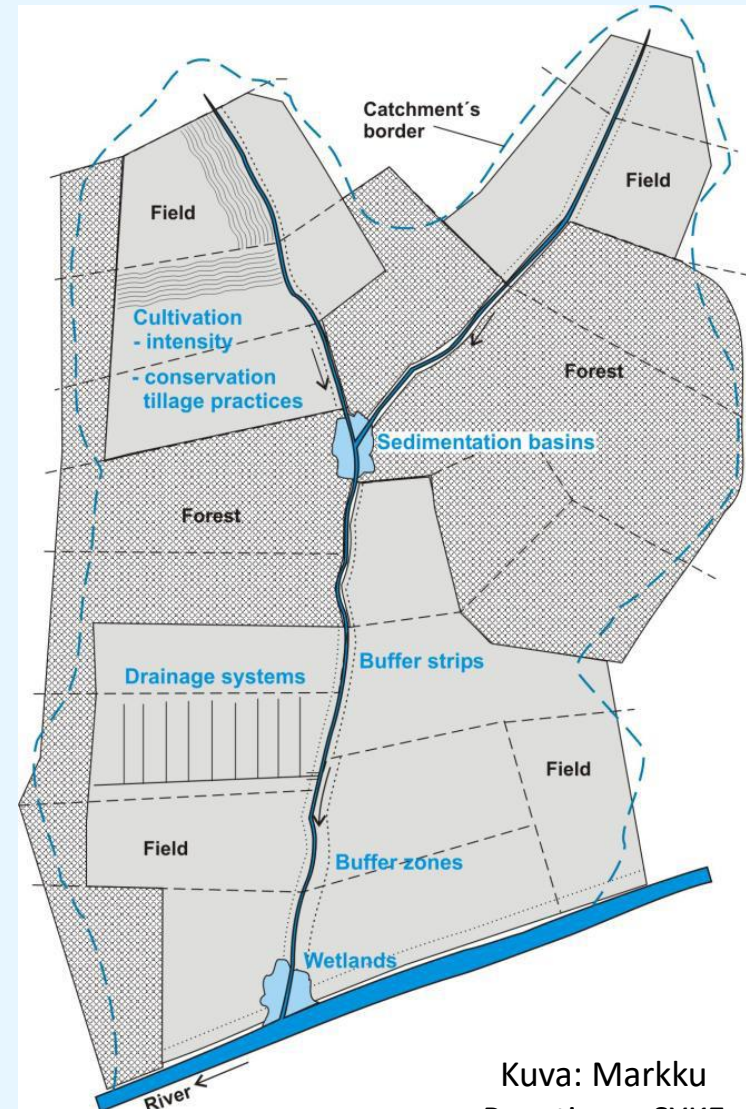
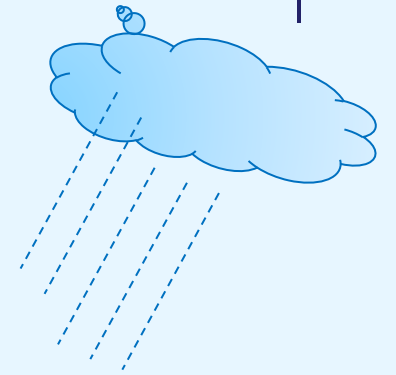

Kuva: Markku
Puustinen, SYKE

Pistekuormitus
Haja-asutuksen
jätevesikuormitus
Hajakuormitus
Ilmaperäinen
laskeuma

Ravinnekuormitukseen vaikuttavia tekijöitä valuma-alueella

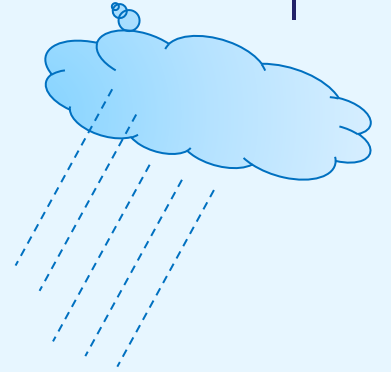

- **Ravinnekuormituksen vaihtelusta selittää yksinään:**
 - › Valunta 70-80 %
 - › Peltoprosentti jopa 60 %
 - › Järviprosentti 50 %
- **Käytettävä laskentamenetelmiä, joilla todellisen muutoksen saa selville**

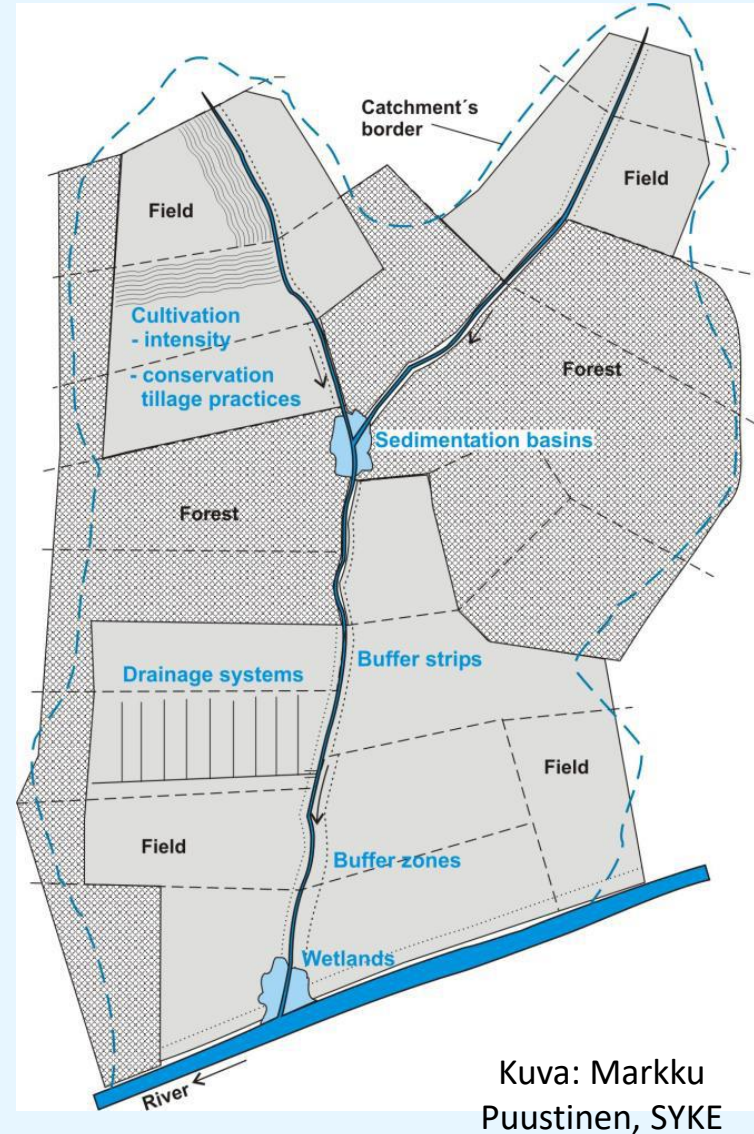
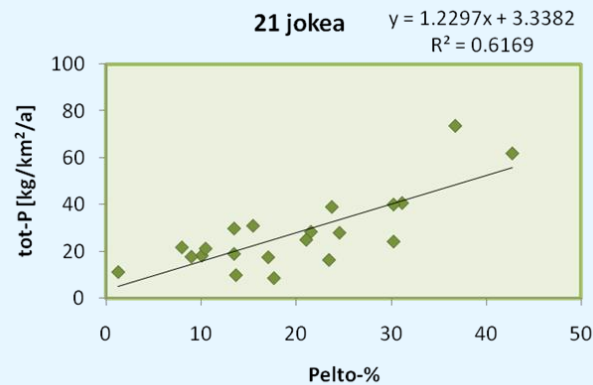
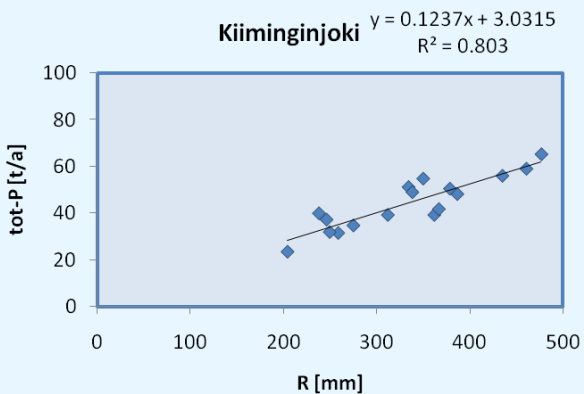

Kuva: Markku Puustinen, SYKE

Pistekuormitus
Haja-asutuksen
jätevesikuormitus
Hajakuormitus
Ilmaperäinen
laskeuma

Ravinnekuormituksen mittaukset

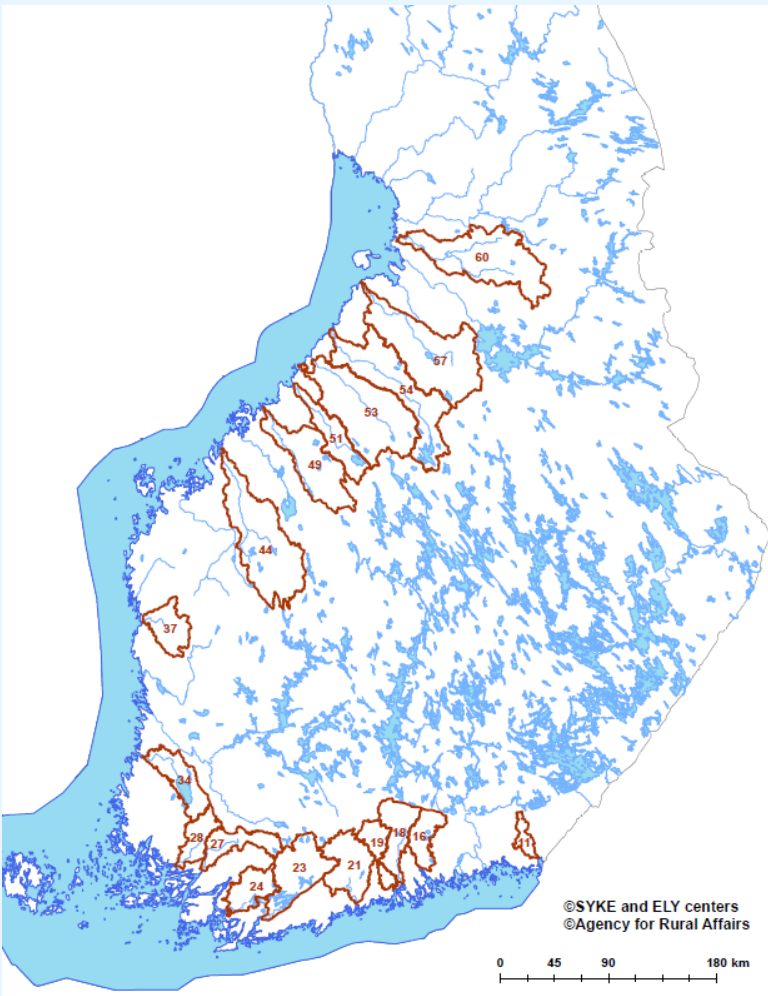

Virtaaman mittaus päivittäin, vedenlaadun mittaus säännöllisesti, myös jatkuvatoimisia ravinnemittauksia

Alue	Joki	Ala [km ²]	Pelto-%	Järvi-%	Merialue
11	Virojoki	357	13	3	Suomenlahti
16	Koskenkylänjoki	895	30	4	Suomenlahti
18	Porvoonjoki	1273	30	2	Suomenlahti
19	Mustijoki	783	29	2	Suomenlahti
21	Vantaanjoki	1686	23	2	Suomenlahti
23	Karjaanjoki	2046	17	11	Suomenlahti
24	Kiskonjoki	629	22	6	Saaristomeri
27	Paimionjoki	1088	42	2	Saaristomeri
28	Aurajoki	874	36	1	Saaristomeri
34	Eurajoki	1336	23	13	Selkämeri
37	Lapväärtinjoki	1098	13	0	Selkämeri
44	Lapuanjoki	4122	22	3	Pohjanlahti
49	Perhonjoki	2524	11	3	Pohjanlahti
51	Lestijoki	1373	11	6	Pohjanlahti
53	Kalajoki	3658	16	3	Pohjanlahti
54	Pyhäjoki	3712	11	5	Pohjanlahti
57	Siikajoki	4318	10	2	Pohjanlahti
60	Kiiminginjoki	3814	2	3	Pohjanlahti

Maatalouden fosforikuormitus laskee

- Fosfori on peräisin maataloudesta ja pistekuormituksesta
- Toimenpiteitä mm. ravinnetaseiden pienentäminen, peltojen kasvipeitteisyys, suojakaistat ja kosteikat, luonnonhoitopellot ym.

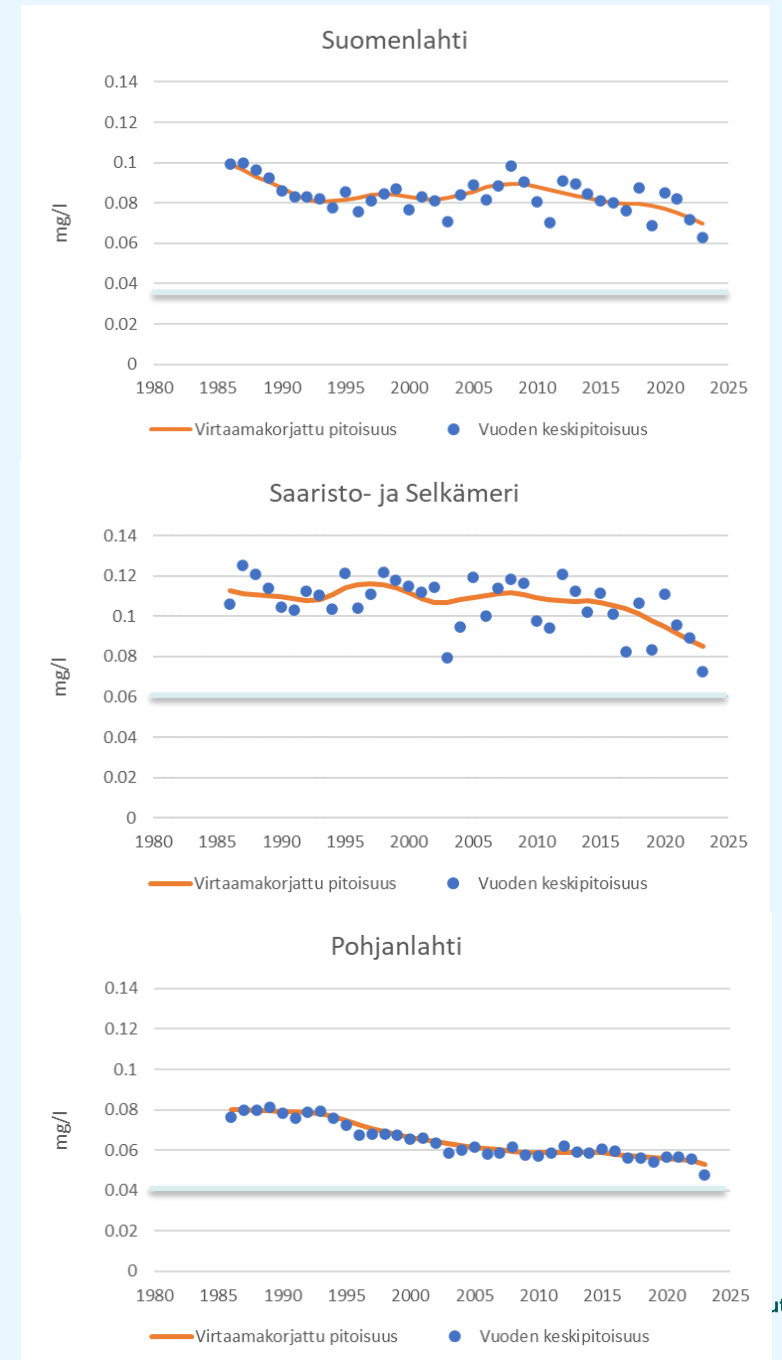
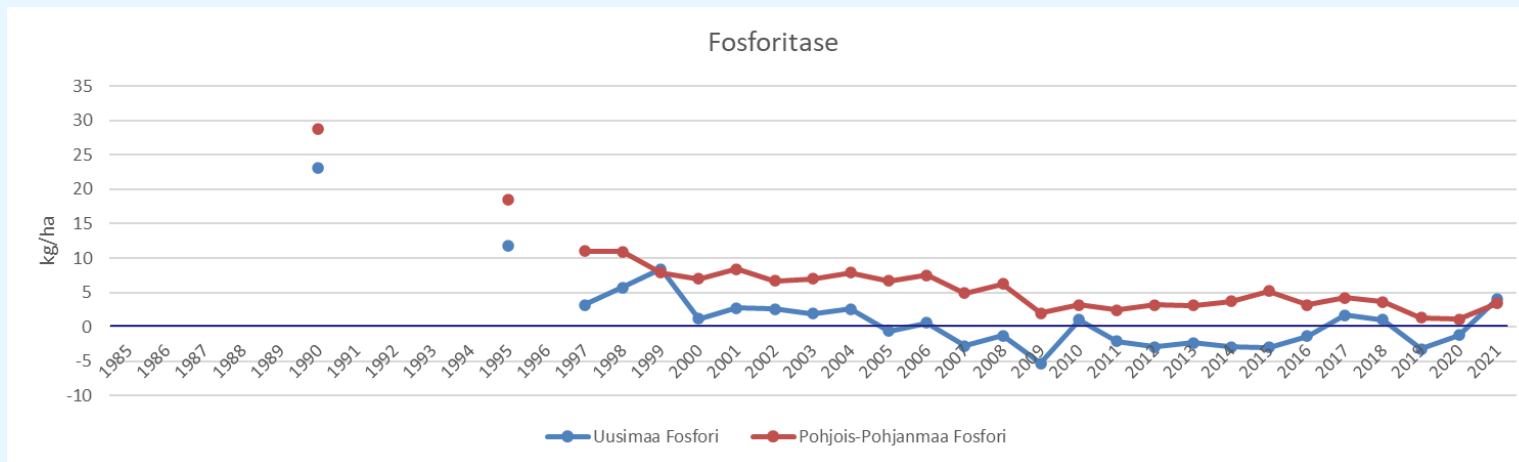

Maatalouden typpikuormitus laskee

- Typpi on peräisin maataloudesta, metsistä ja pistekuormituksesta
- Toimenpiteitä mm. ravinnetaseiden pienentäminen, peltojen kasvipeitteisyys, suojakaistat ja kosteikat, luonnonhoitopellot ym.

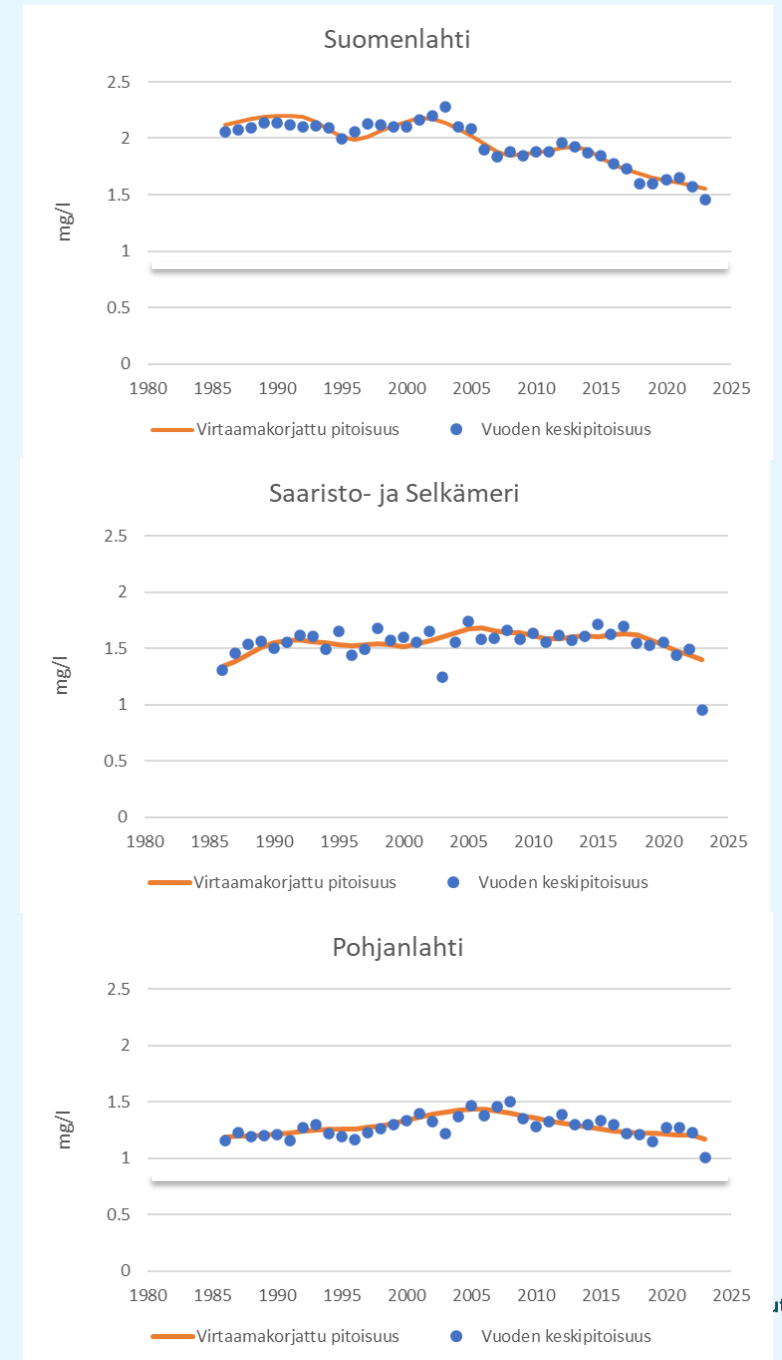
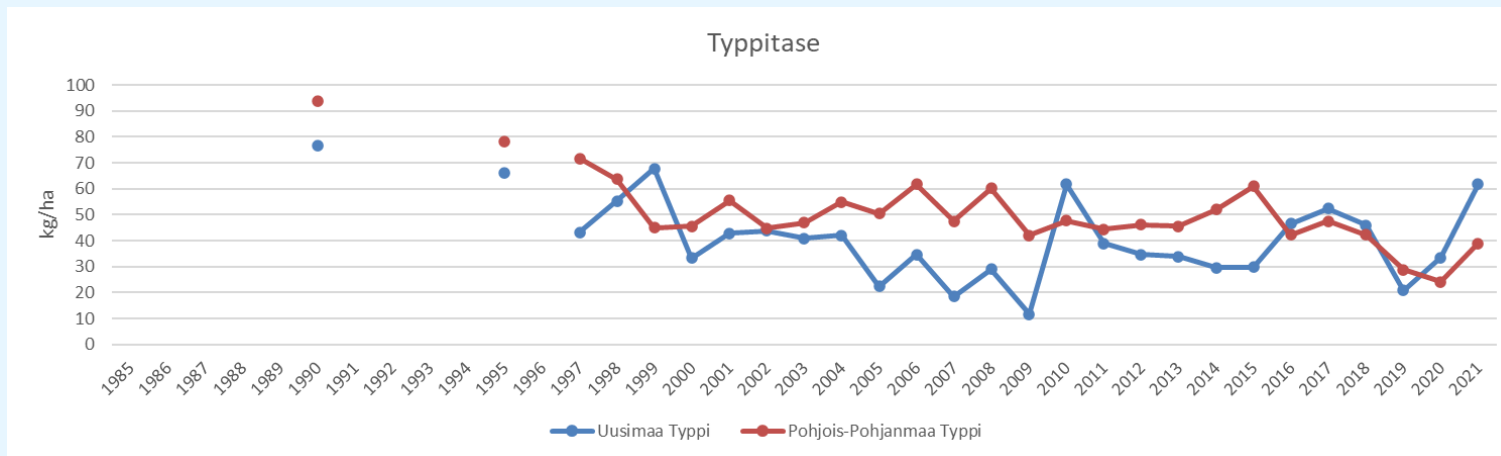

Vesien ruskettuminen jatkuu

- **Syitä: happamoittavan laskeuman väheneminen, ilmastonmuutos, maankäytön muutos**
- **Hiili on peräisin lähinnä suometsistä ja soilta**
- **Erytisesti Pohjanmaan joissa on korkeat hiilipitoisuudet**
- **Vesiensuojelutoimenpiteet eivät vähennä liukoista hiiltä**

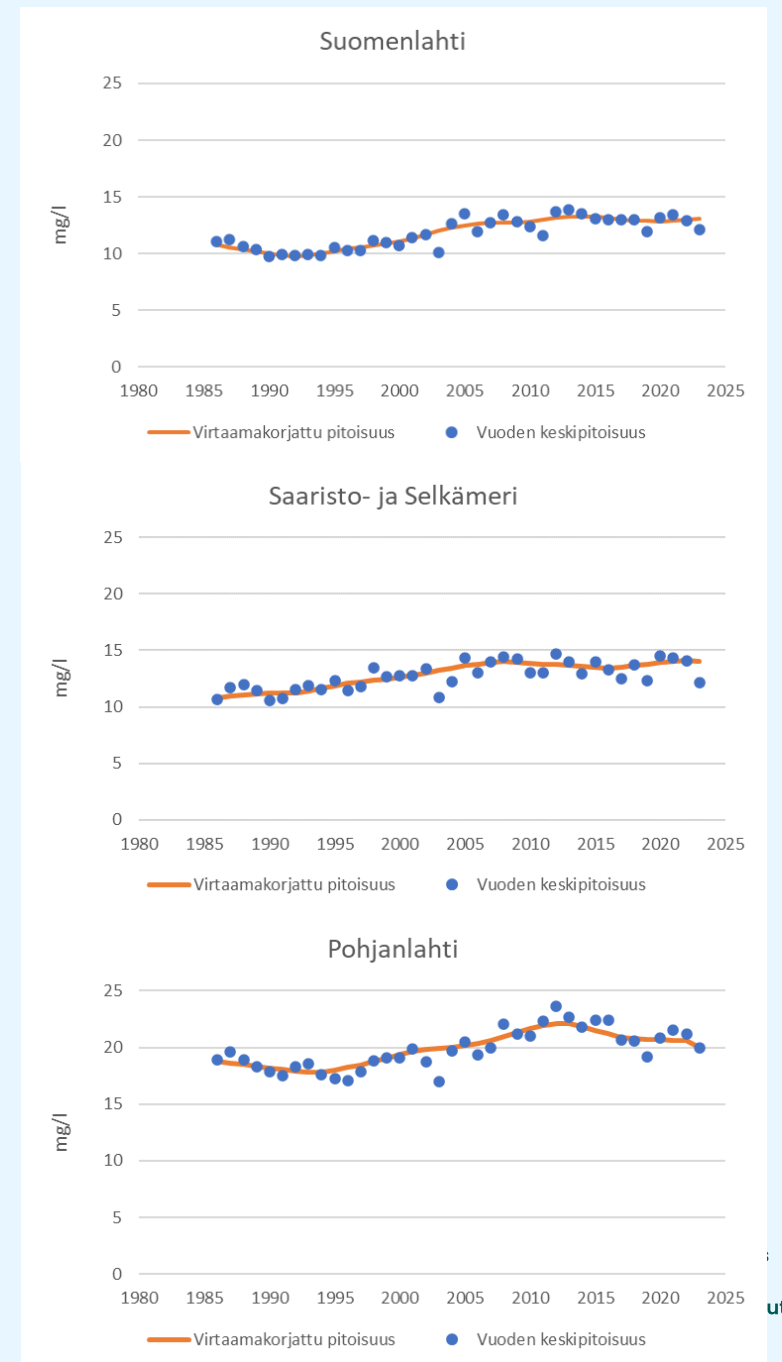

Ravinnesuhteiden muutos

- Liebigin minimitekijälaki: vähäisin ravinne rajoittaa kasvua
- Stoikiometria: hyvä OC saatavuus suosii mikrobiologisia prosesseja joessa
- Järvien lisäksi myös joet pidättävät ravinteita lyhyestä viipymästä huolimatta
- Suomenlahden ja Saaristo- ja Selkämeren joet ovat heterotrofisten mikrobien mukavuusalueella (vihreä laatikko)
- Pohjanlahteen laskevissa joissa orgaanista hiiltä on ylimäärin, joten se kasvattaa mikrobimassaa alempana vesistössä, jos siellä on riittävästi ravinteita

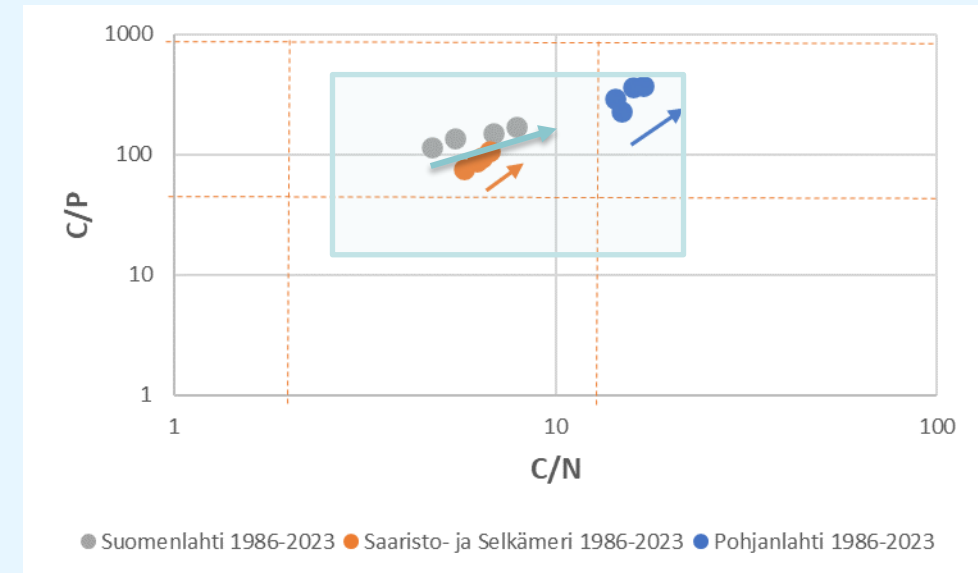
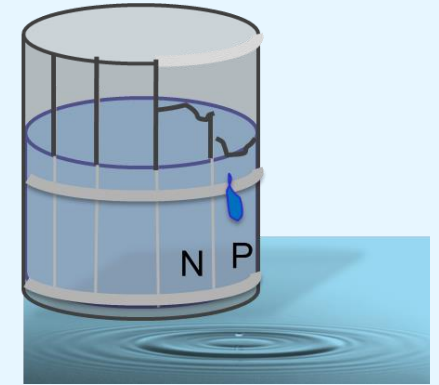

Stutter et al. 2018

Mitä muutoksia Temmesjoella?

- Temmesjoen virtaama- ja vedenlaatumittaukset eivät muodosta jatkuvaa aikasarjaa
- **Kokonaistypen pitoisuuden aikasarja noudattaa Pohjanlahden jokien keskimääräistä kehitystä**
- Kokonaisfosfori on selvästi korkeammalla tasolla
- **Orgaanisen hiilen pitoisuus nousee, mutta on edelleen matalampi kuin Pohjanmaan joissa keskimäärin**

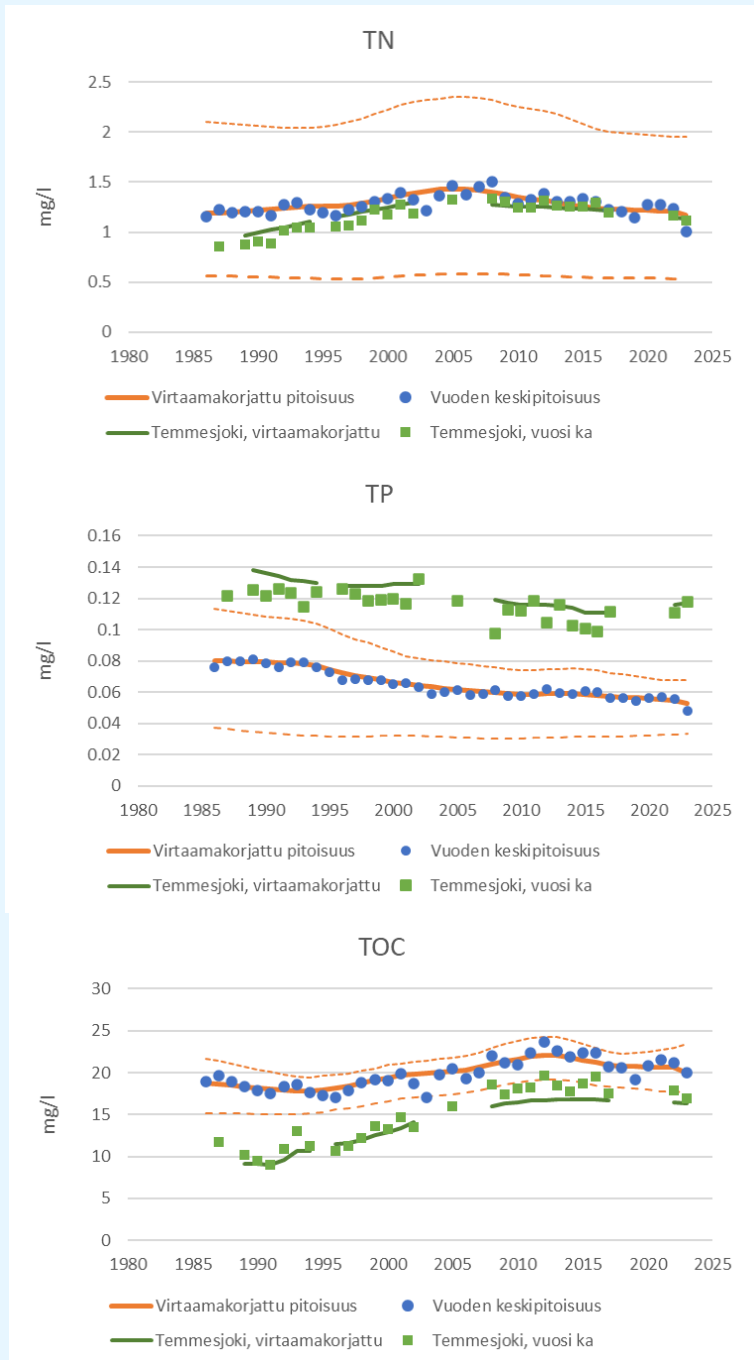

Mitä muutoksia Temmesjoella?

- Temmesjoen ravinnesuhteet ovat muuttumassa heterotrofisten mikrobien mukavuusalueelta kohden runsashiilistä aluetta
- **Koska mittaukset ovat Temmesjoen alaosasta, ylimääräinen orgaaninen hiili kulkeutuu mereen**
- Lisää meren ruskettumista, ja mikäli ravinnekuorma mereen kasvaa, lisää sitoutumista mikrobeihin

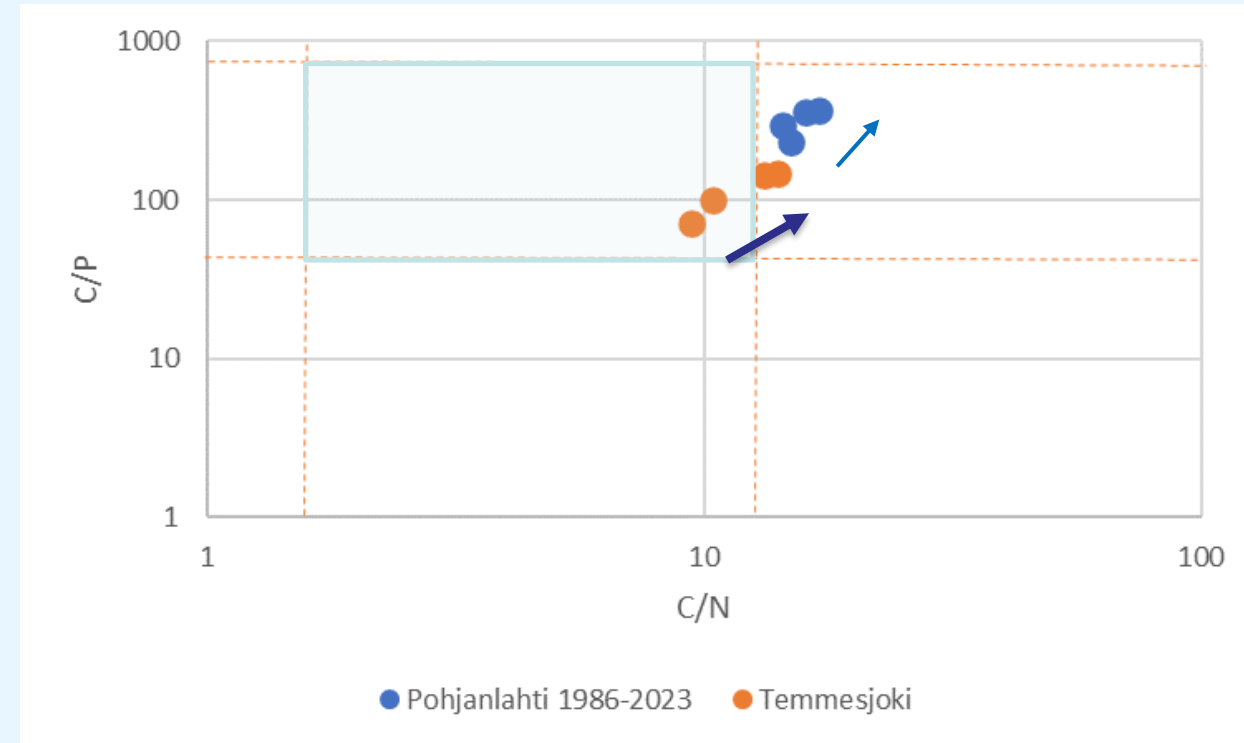

Kysymyksiä?

Miksi Temmesjoen fosforipitoisuudet ovat korkeampia kuin muissa Pohjanmaan joissa?

Miten Temmesjoen fosforipitoisuutta voisi laskea?



Kiitos!

Nordbalt Eco-Safe



MALLINTAMALLA LISÄÄ TIETOA RAVINNEKUORMASTA

Hannu Marttila, Joy Bhattacharjee

Oulun yliopisto

Temmesjoki ja Tyrnävänjoki

Tavoitteet

- › Ekologinen ja kemiallinen tila huono
- › Ravinteiden ja kiintoaineen pitoisuudet korkeita
- › Tavoite: Mallintaa hydrologiaa ja veden laatua SWAT+ mallilla, jotta ymmärretään paremmin typen (N) ja fosforin (P) kulkeumareitit ja lähteet, ja voidaan paremmin ohjata toimenpiteitä ja vähentää ravinnekuormitusta

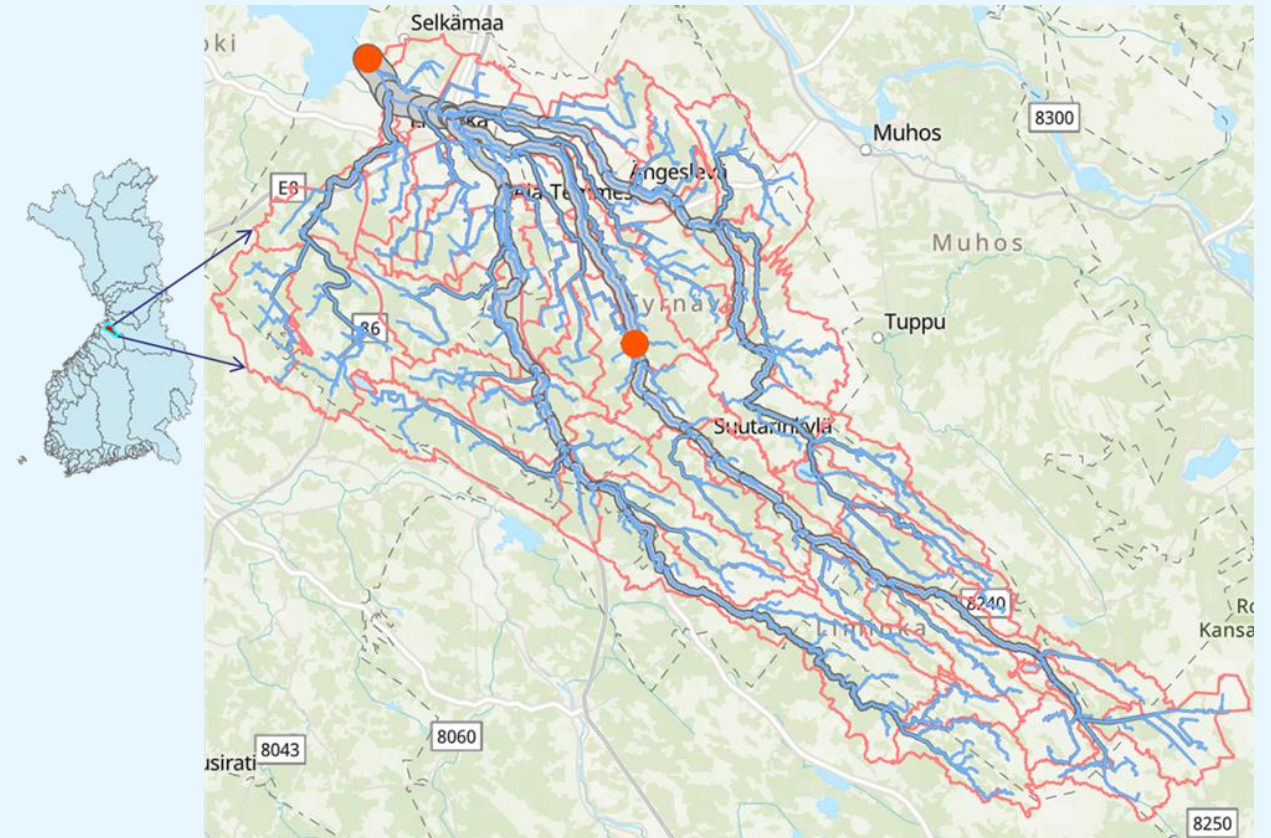

Temmesjoki ja Tyrnävänjoki

Mallinnuksen tavoitteet

Askel-1: SWAT+ mallin rakentaminen, kalibrointi ja validointi

Askel-2: SWAT+ mallin vertailu kansallisen VEMALA mallin kanssa

Askel-3: Ekologisesti turvalliset typen (N) ja fosforin (P) vähennys tavoitteet nykyisessä ja tulevaisuuden ilmastossa

Temmesjoki ja Tyrnävänjoki

Askel-1: Mallintaminen ja olemassa oleva data

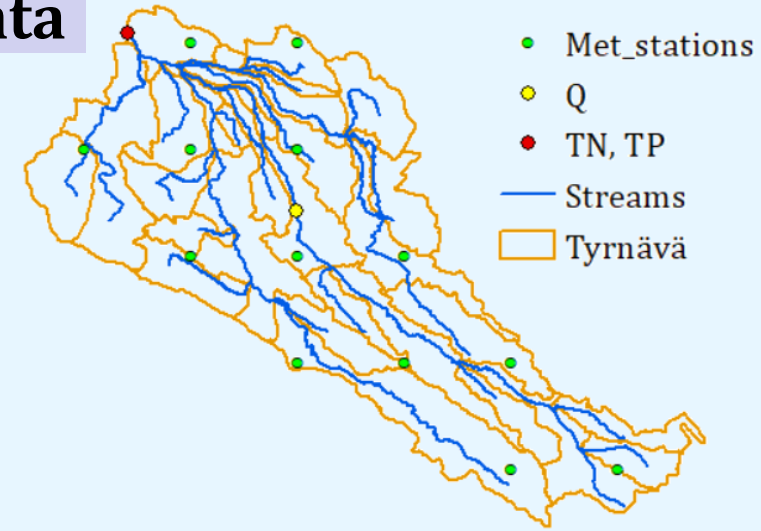
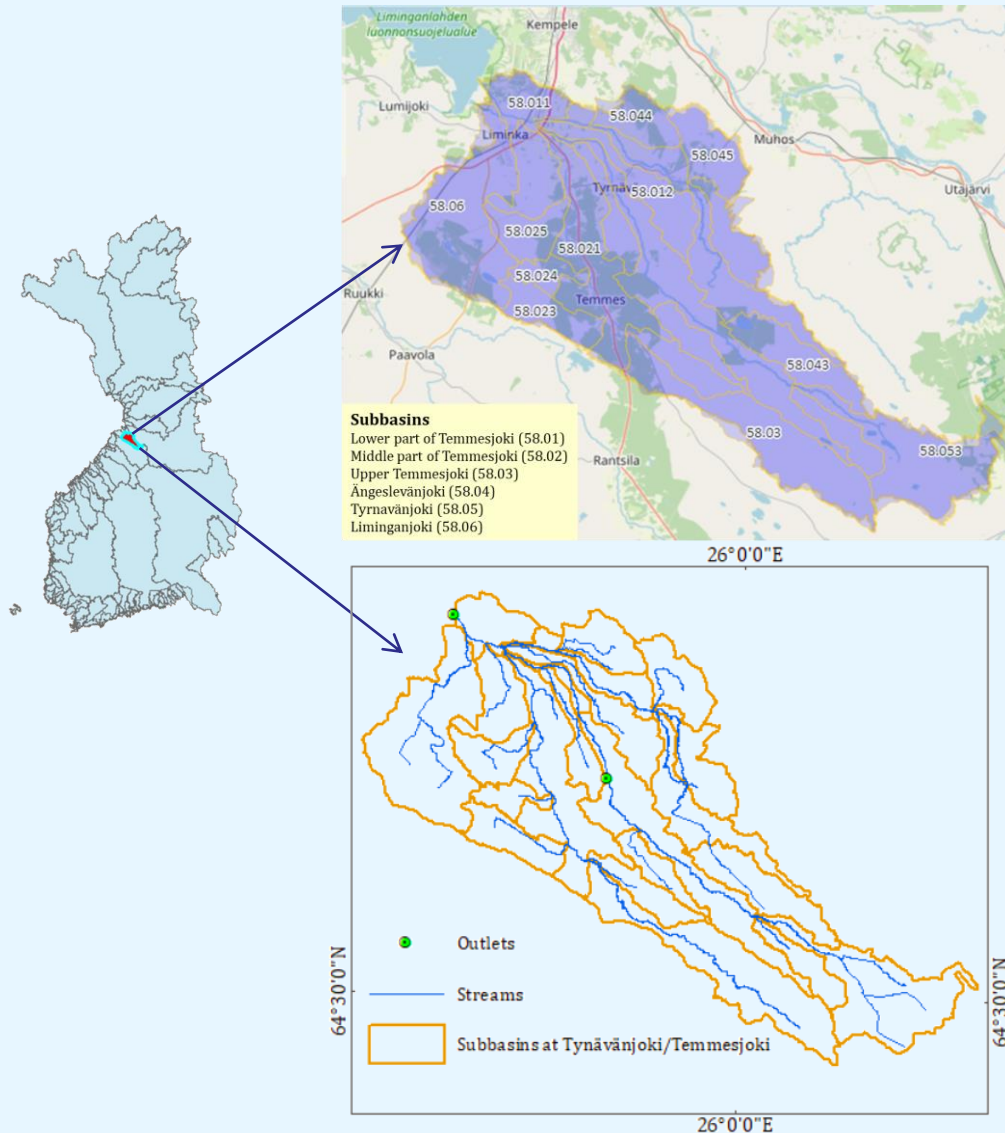

Virtaama ennen merta

Temmesjoki ja Tyrnävänjoki

Askel-1: Mallintaminen ja olemassa oleva data

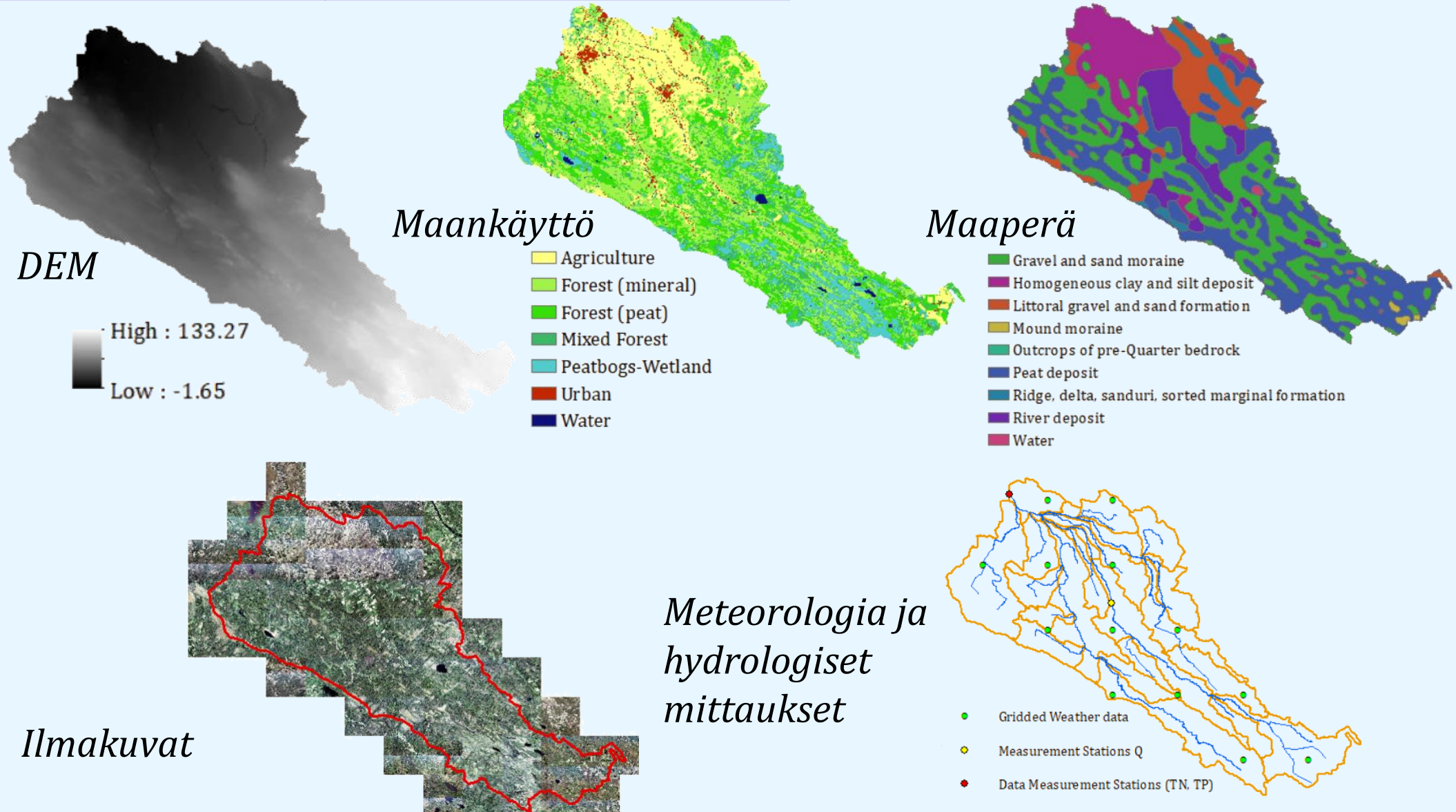

Temmesjoki ja Tyrnävänjoki

Askel-1 → Askel-3: Mallintaminen

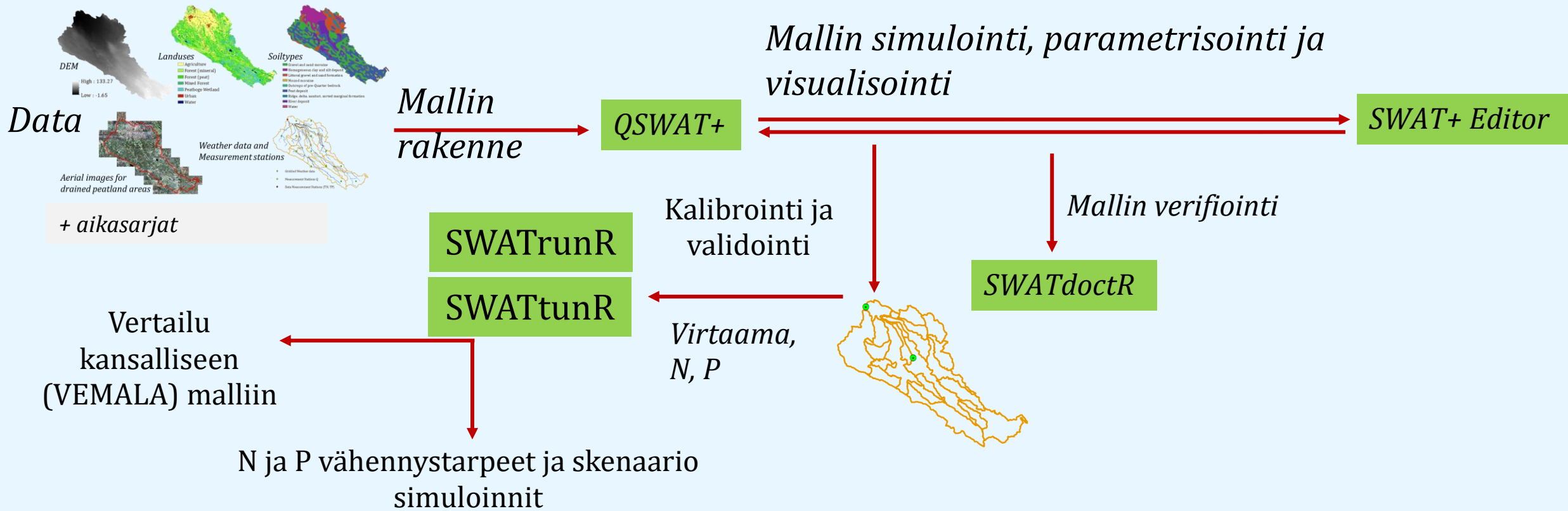

Temmesjoki ja Tyrnävänjoki

Askel-1 & Askel-2: Mallinnuse tulokset (Virtaama)

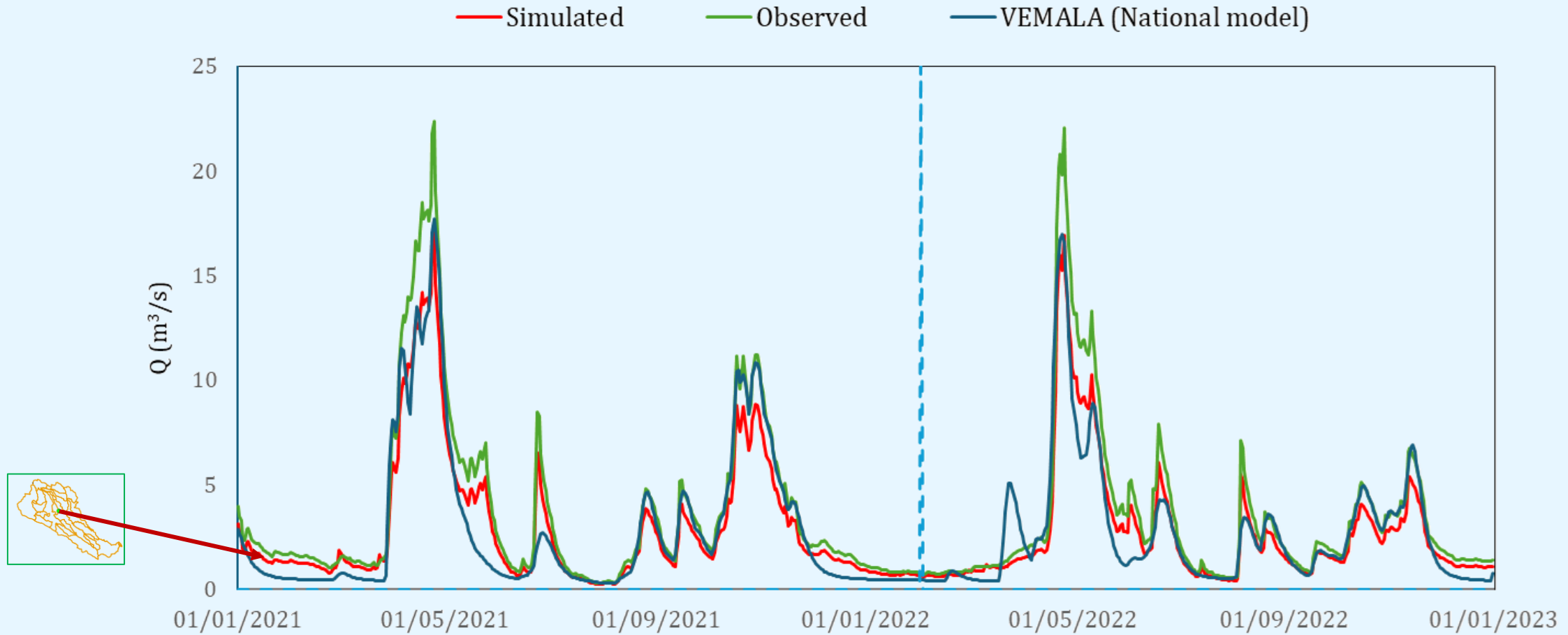

Temmesjoki ja Tyrnävänjoki

Askel-3: N ja P vähennys tavoitteet ja skenaariot

Typpi	N vähennystehokkuus %
Rakennettu kosteikko	14- 54
Kerääjäkasvit	32
Kasvittunut suojavaöhyke	57

Fosfori	P vähennystehokkuus %
Rakennettu kosteikko	34 (6-62)
Kerääjäkasvit	30
Maanmuokkauksen vähentäminen ja suorakylvö	27-50
Kipsikäsittely	50
Kasvittunut suojavaöhyke	27-97
Kaksitasouomat	14
Lannoituksen vähentäminen	7 to 19

Temmesjoki ja Tyrnävänjoki

Askel-3: N ja P vähennys tavoitteet ja skenaariot

Vesiensuojelu-keino N ja P kulkeuman vähentämiseen	Mahdollista simuloida SWAT+ mallilla	Huuhtouma juurivyöhykkeestä	Pintavalunta	Salaojavalu	Pohjavesivalunta	Joen virtaama	Tulvan hallinta	Kuivuuden hallinta	Metaanipäästöt	N2O päästöt	Hiilen pidättäminen	Sedimentin pidättäminen	Biodiversiteetti	Fosforipäästöt maaperästä
Pintavalutuskentät ja kosteikot	+		x				0	0	0	-	0	+	+	+
Soiden ja kosteikkojen ennallistaminen	+		x	x	x	x	+	+	-	-	+	+	+	-
Kasvittuneet suojavöhykkeet	+	x					0	0	0	0	+	+	+	0
Kerääjäkasvit	+								x	x				

Mitkä keinot ovat realistisia ja toteutettavissa olevia Temmesjoen valuma-alueella?

KIITOS! KYSYMYKSIÄ?

ENGLISH VERSION NEXT

Tyrnävänjoki

Status of the Catchment

Catchment area (km ²)	1181
Average precip. (mm/yr)	477
Mean temperature (°C)	2.6
Mean streamflow (mm)	231
Agriculture (%)	15
Forest (%)	82

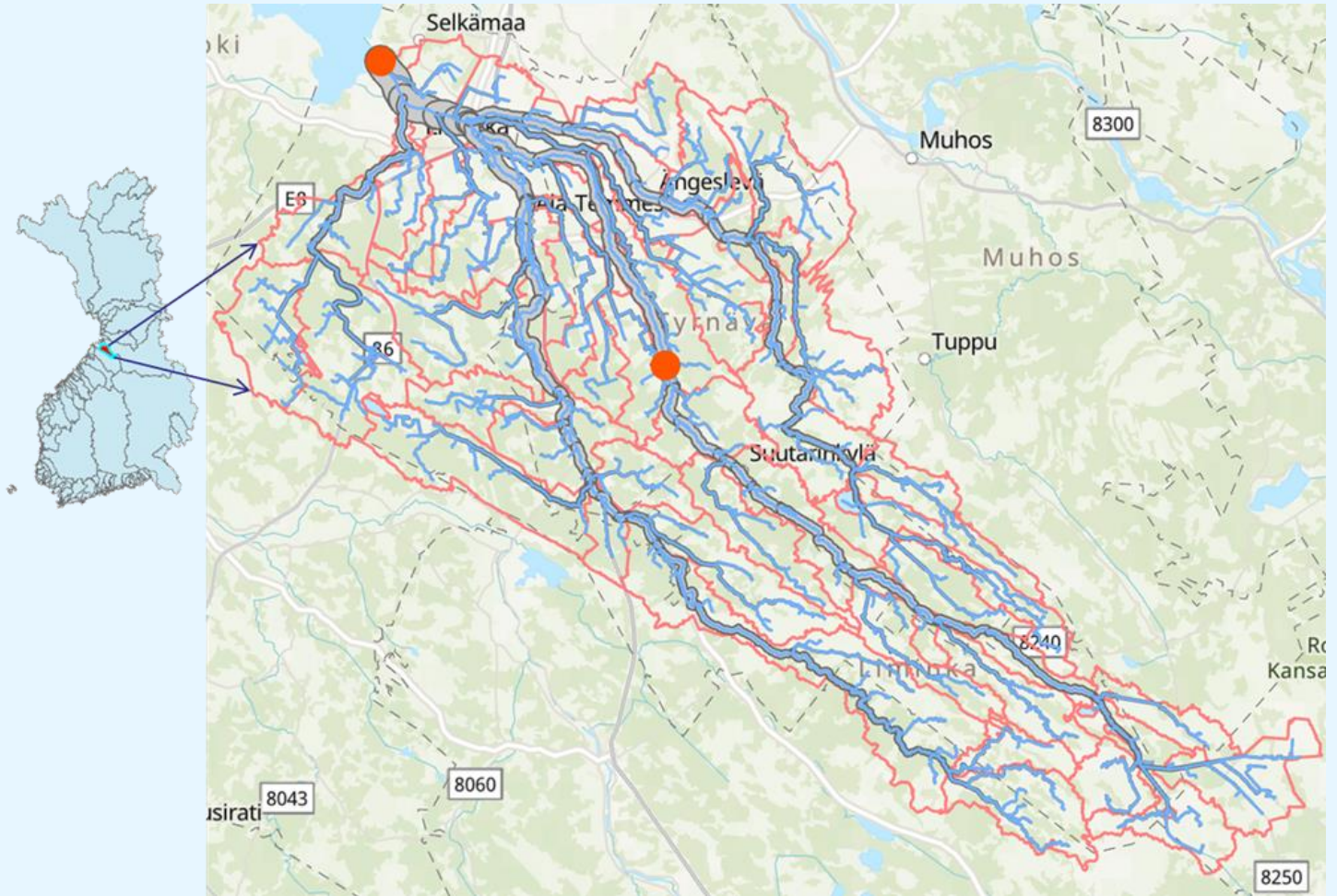

Watershed, subbasins and streams are delineated by the SWAT+ model with floodplain delineation (areas delineated as light-shaded areas indicate floodplains). The stream gauge stations at Temmesjoki River and most downstream outlets at Tyrnävä are indicated by red points.

Why this Project is important?

The river Temmesjoki has two tributaries: River Tyrnävänjoki and River Angeslevänjoki, which have a poor ecological status.

The concentrations of nutrients and suspended solids are very high, and the ecological status of the main river channel is poor.

Thus, the objectives of the current study are to apply the SWAT+ model in the Temmesjoki (Tyrnävänjoki) river basin and to understand the status of Nitrogen (N) and Phosphorus (P) and nutrient sources, pathways and to reduce nutrient emissions efficiently.

Goals of the Project

Step-1: Setup, calibration, and validation of SWAT+ models in the Tyrnävänjoki River basin

Step-2: Comparison of the SWAT+ model to the existing national model of Finland (VEMALA)

Step-3: Identification of N and P reduction targets and setup scenarios to bring nutrients within safe ecological boundaries under current and future climate conditions

Tyrnävänjoki

Step-1: Modelling (Available Data)

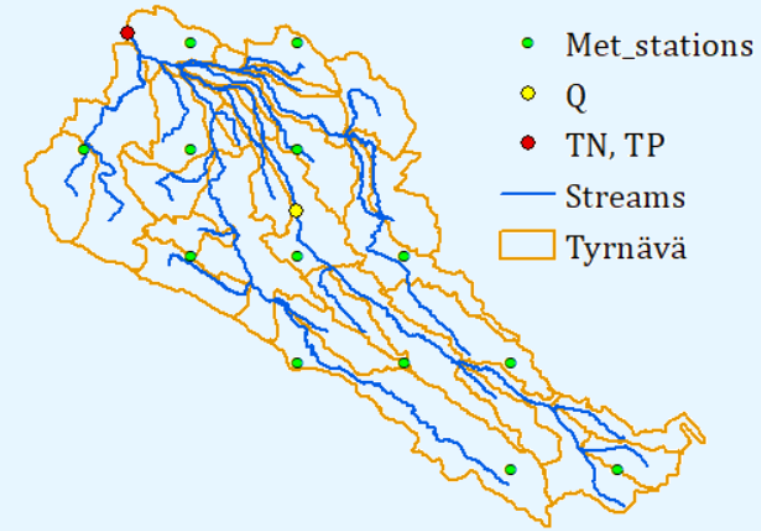
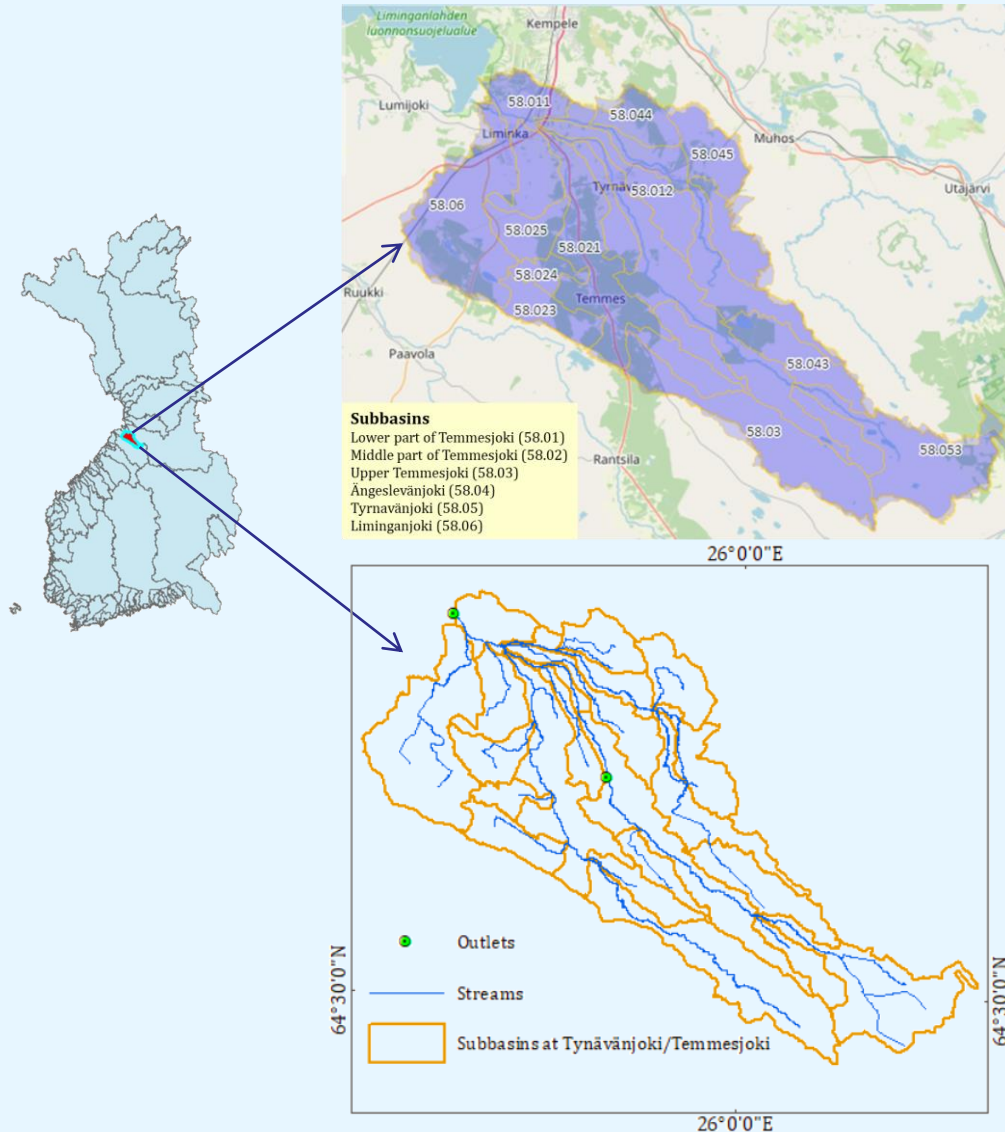

Discharge at the most downstream outlet

Tyrnäväenjoki

Step-1: Modelling (Available Data)

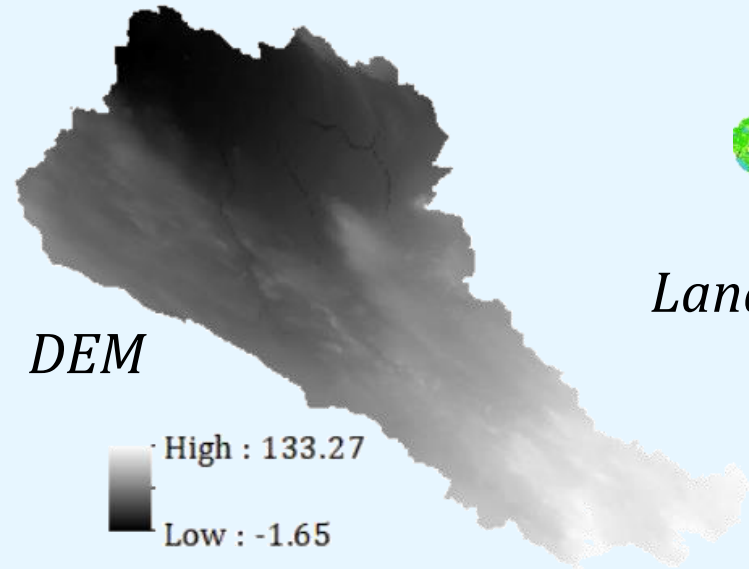

Landuses

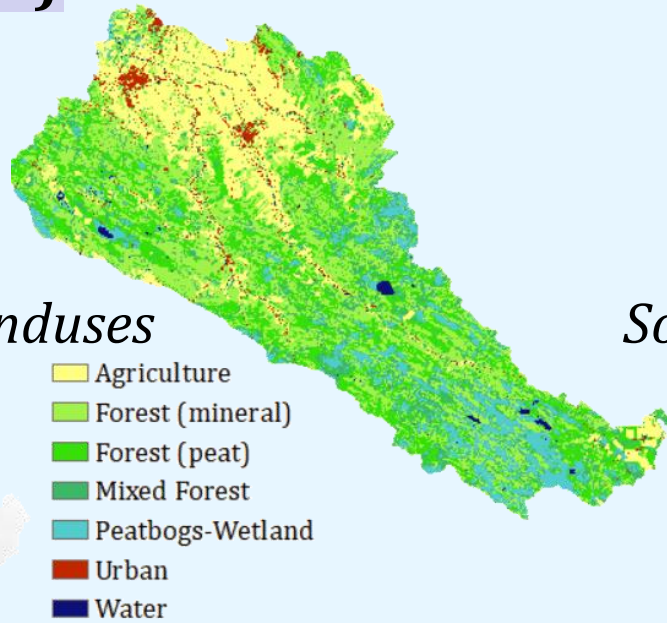

Soiltypes

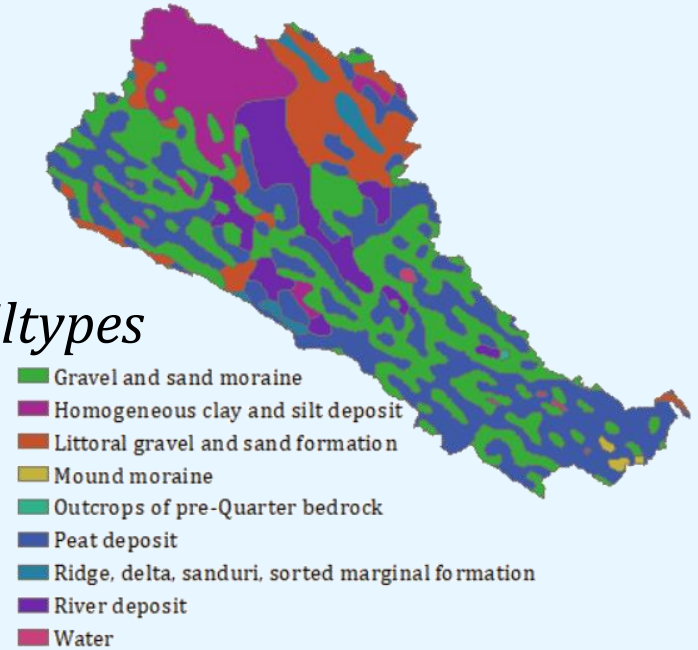

Weather data and Measurement stations

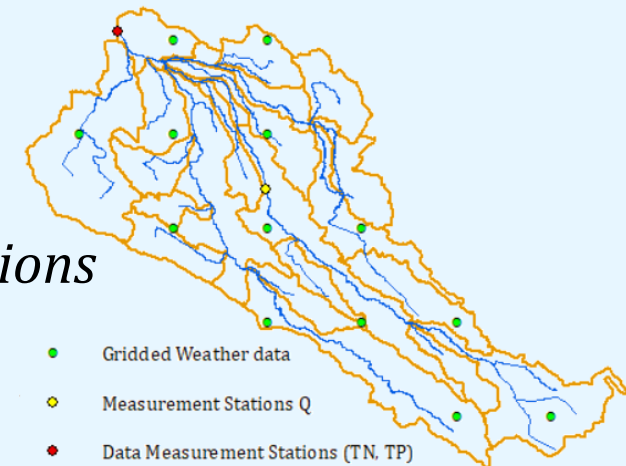

Tyrnävänjoki

Step-1 to Step-3: Modelling (Procedures)

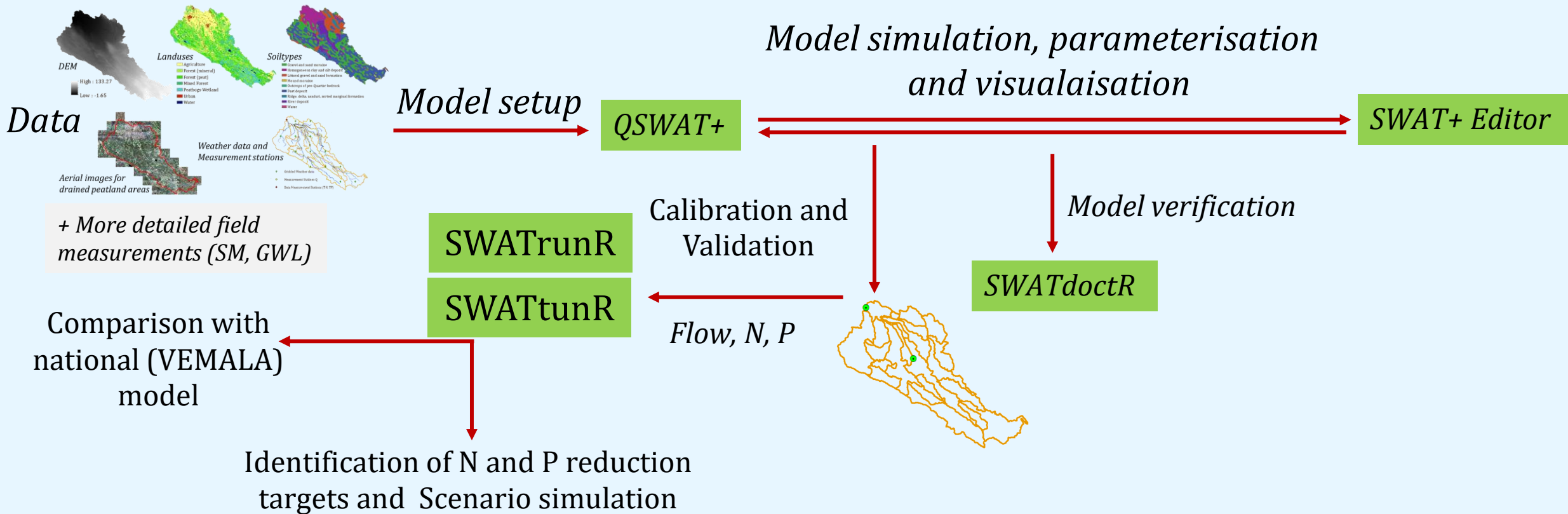

Tyrnävänjoki

Step-1 to Step-3: Modelling (Procedures)

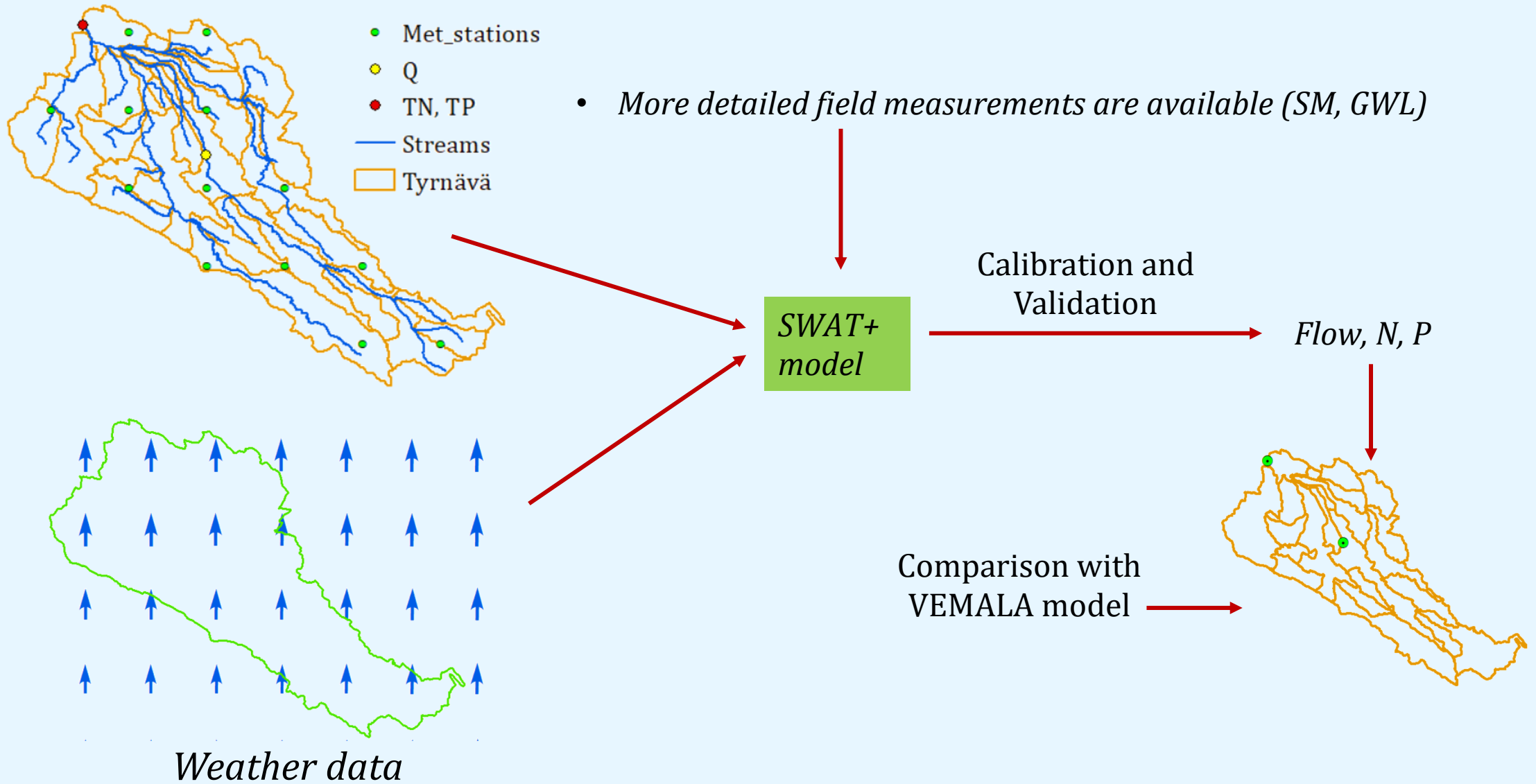

Tyrnävänjoki

Step-1 & Step-2: Modelling (Results-Flow)

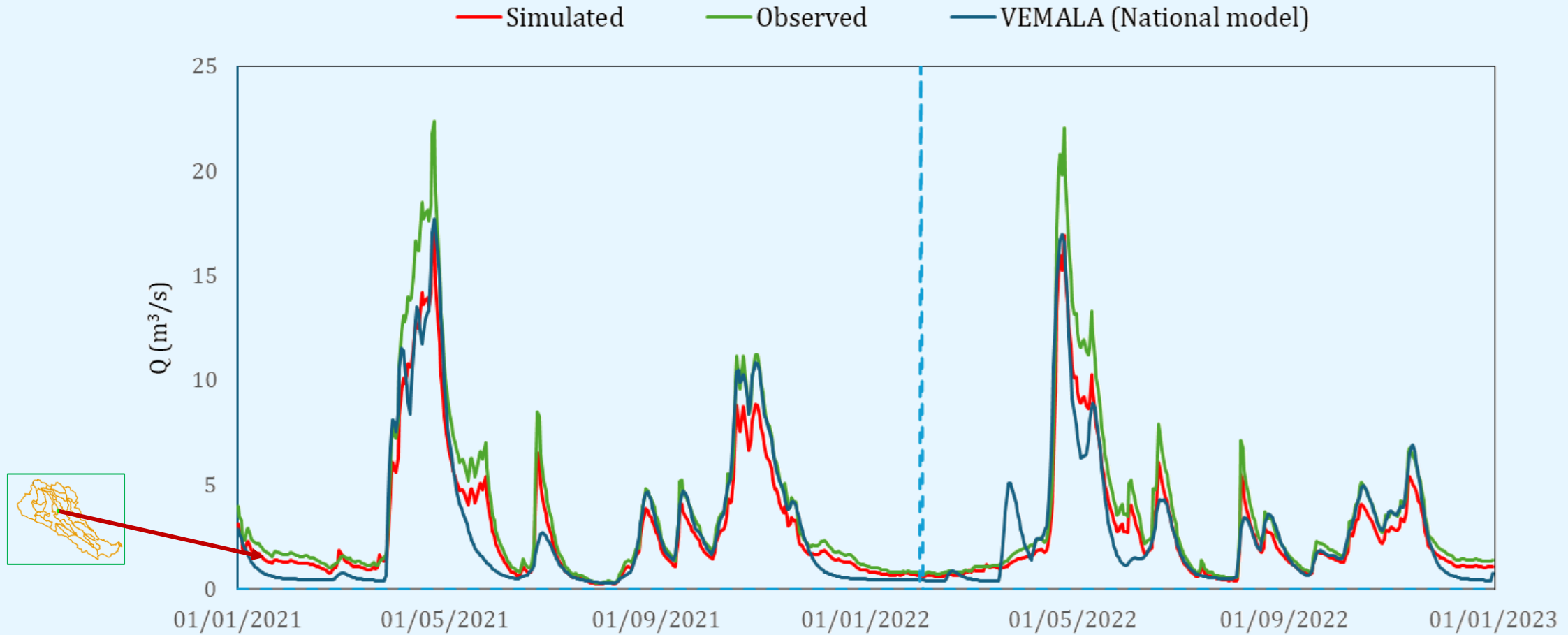

Tyrnävänjoki

Step-3 : N and P reduction targets and setup scenarios

Nitrogen	N reduction efficiency in %
Constructed wetlands	14- 54
Catch crops	32
Buffer strips with grass	57

Phosphorus	P reduction efficiency in %
Constructed wetlands	34 (6-62)
Catch crops	30
Reduced tillage and direct seeding	27-50
Application of gypsum or structure lime	50
Buffer strips with grass	27-97
Two stage ditches and channels	14
Reduced fertilizer use	7 to 19

Step-3 : N and P reduction targets and setup scenarios

Transport mitigation measures to reduce N & p target	Possibility to simulate in SWAT+	Leaching from the root zone	Surface runoff	Tile flow	Groundwater flow	Stream flow	Flood control	Drought mitigation	Methane emissions*	N2O emissions*	Carbon sequestration	Sediment retention	Biodiversity***	Phosphate emissions from soils
Surface constructed wetlands (on fields)	+		x				0	0	0	-	0	+	+	+
Restored wetlands	+		x	x	x	x	+	+	-	-	+	+	+	-
Buffer strips with grass	+	x					0	0	0	0	+	+	+	0
Catch Crops	+								x	x				



Funded by the
European Union

This project has received funding from the European Union's Horizon Europe research and innovation programme under Grant Agreement No. 101060020



WP 5: Luontopohjaiset ratkaisut ja vesiensuojelutoimenpiteet

Katrin Bieger & Brian Kronvang

Pasi Valkama



Ravinnehuuhtoumaa vähentävät toimenpiteet

Mitä teemme:

Tunnistetaan Pohjoismaiden ja Baltian alueella vakiintuneimmat ravinnehuuhtoumien vähentämistoimenpiteet ja laaditaan luokittelu, jossa otetaan huomioon tekijöitä, jotka ovat olennaisia tietyn toimenpiteen valinnassa, suunnittelussa ja arvioinnissa (ravinteiden kulkeutumisreitit, ravinteiden vähentämisen tehokkuus, muut hyödyt ja -haitat, toimeenpanon esteet).

Vesiensuojelutoimenpiteiden luokittelua

- › Vedenlaadun hallinnan perusta on ravinnehuuhtoumien ehkäiseminen ja vähentäminen lähtöalueella
- › Toimenpiteet, joilla puututaan kuormitukseen uomastossa eivät toimi tehokkaasti, jos valunta ja ravinnepitoisuudet ovat hyvin suuria

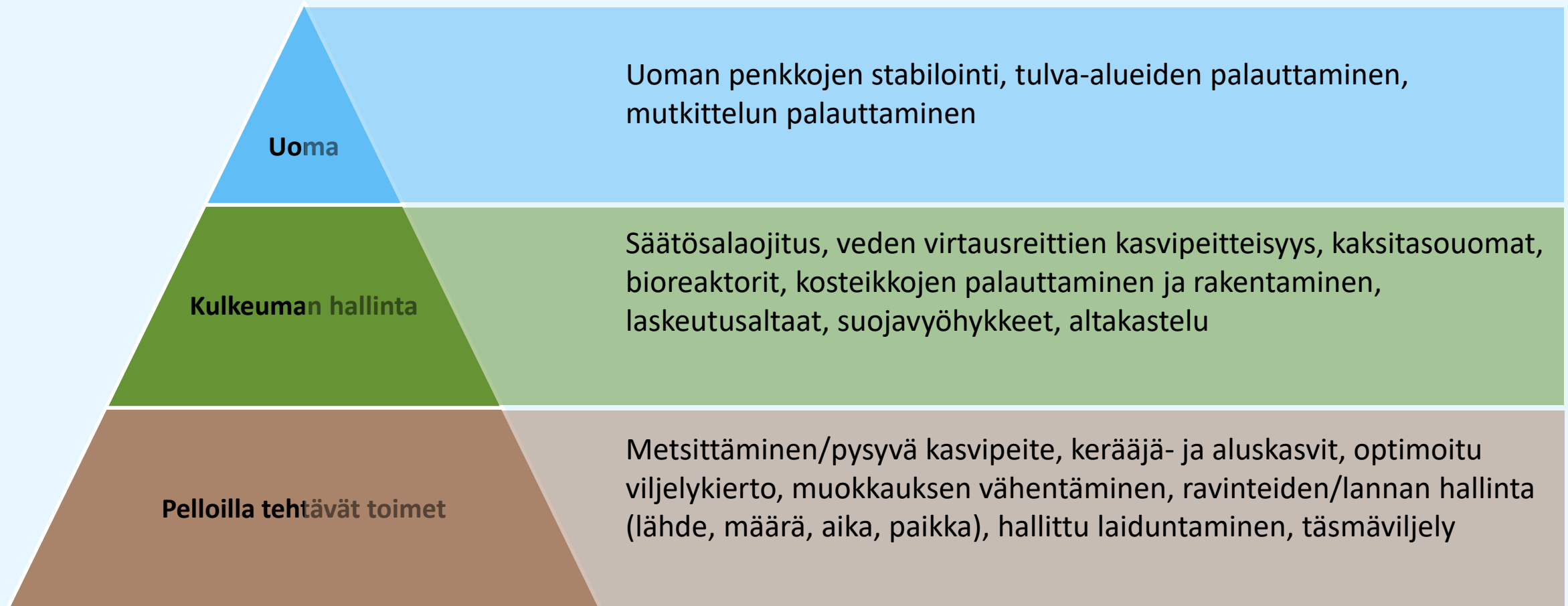

Portfolio

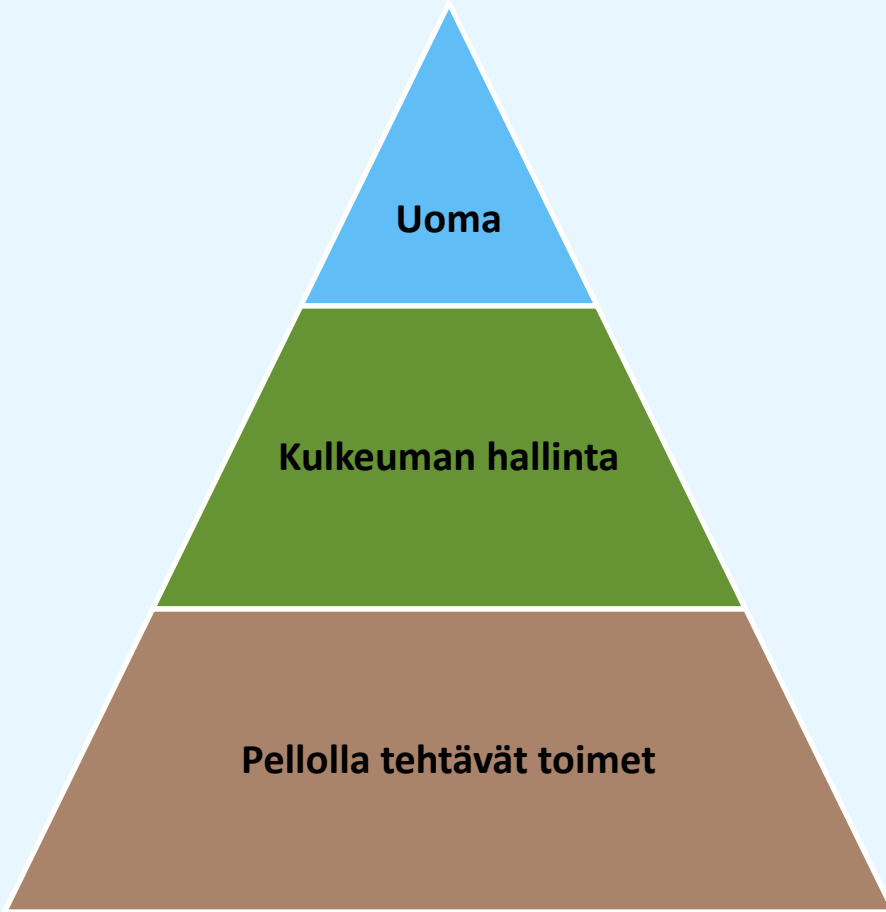

	DK	NO	SE	FI	LV	PL
Pelloilla tehtävät toimet						
Viljelykierto				X	X	X
Kerääjä- ja aluskasvit	X	X	X	X	X	X
Syysviljan aikainen kylvö	X					X
Pysyvä kesanto	X		X	X		X
Kesanto viljelykierron osana	X		X	X	X	X
Pysyvät nurmet, niityt ja laitumet				X	X	X
Energiakasvit	X		X	X	X	X
Metsittäminen	X		X	X		X
Kevennetty muokkaus ja suorakylvö	X	X	X	X	X	X
Kevennetty muokkaus – ei syyskylvöä		X	X	X		X
Kate						X
Syvämuokkaus jankkurointi				X		X
Maanparannusaineiden, kuten rakennekalkin ja kipsin käyttö			X	X	X	X
Täsmälannoitus (minerrallannoite ja lanta)	X	X	X	X	X	X
Lannoitteiden vähennetty käyttö	X				X	X
Nitrifikaation hidastaja lietelannassa	X					
Lannan levitystä koskeva sääntely			X	X	X	X
N- ja P- lannoituksen raja-arvot lannalle	X		X	X		X
Kulkeuman hallinta						
Surface constructed wetlands	X		X		X	
Ennallistetut kosteikot	X	X	X	X	X	X
Bioreaktorit hakkeella	X			X		
Säätösaloitus	X		X	X		X
Tulvaniityt kuivatusvesille	X					
Kosteikkoviljely	X			X		X
Suojakaistat, joissa on ruohoa tai puita	X	X	X	X	X	X
Integroidut ja kyllästetyt suojavyöhykkeet	X					
Ruohoa/heinää kasvavat virtausreitit		X	X			X
Kasvipeite / ei maanmuokkausta alueilla, joilla tulva- ja/tai eroosioriski on suuri		X	X		X	X
Uomissa tehtävät toimenpiteet						
Rakennetut kosteikot	X	X	X	X	X	X
Laskeutusaltaat metsäalueilla		X	X	X		X
Uomien mutkittelun palauttaminen	X	X	X	X		X
Kaksitasouomat	X		X	X		
Uomien ennallistaminen, pohjien kunnostaminen						X

Vesiensuojelutoimenpiteiden kohdentaminen valuma-alueella

- Toimenpiteiden tehokkuus ravinnekuorman vähentämisessä riippuu sen sijainnista suhteessa kriittisiin kuormituksen lähtöalueisiin, kulkureitteihin ja vastaanottaviin vesistöihin
- Hankkeessa tunnistetaan aluekohtaisesti mahdollisuudet toimenpiteiden toteuttamiseen paikkatietoanalyysin, SWAT+-mallinnuksen ja aiempiin tutkimuksiin perustuvien toimenpiteiden huuhtouman vähennystehon perusteella
- Täsmällisten suositusten sijaan maanomistajille ja paikallisille/alueellisille sidosryhmille annetaan mahdollisuus valita mailleen ja vesistöalueelleen sopivat vaihtoehdot

Esimerkki: Kosteikkojen ennallistaminen Tanskassa

Vaihe 1: Tulvatasanteiden rajaaminen, valuma-alueen kosteikon ennallistamiseen soveltuvien alueiden tunnistaminen SWAT+-rajapinnan avulla.

Vaihe 2: Kaupunkialueiden poissulkeminen, koska ne eivät sovellu kosteikkojen ennallistamiseen.

Vaihe 3: Karttojen tarkastelu työpajoissa “Odense Fjord Kystvandrådet” ja “Odense Fjord Samarbejdet” 9. lokakuuta 2023 ja kosteikkojen ennallistamiseen soveltumattomien alueiden poissulkeminen paikallisen suunnittelun avulla seitsemässä kunnassa, jotka sijaitsevat (osittain) Odensen vuonon valuma-alueella.

Step 4: 1. Optimistisen ja 2. konservatiivisen skenaarion kehittäminen → perustuvat työpajojen tuloksiin ja karttoihin jo olemassa olevista kosteikoista.



Lopullinen kartta ja mallin tulokset

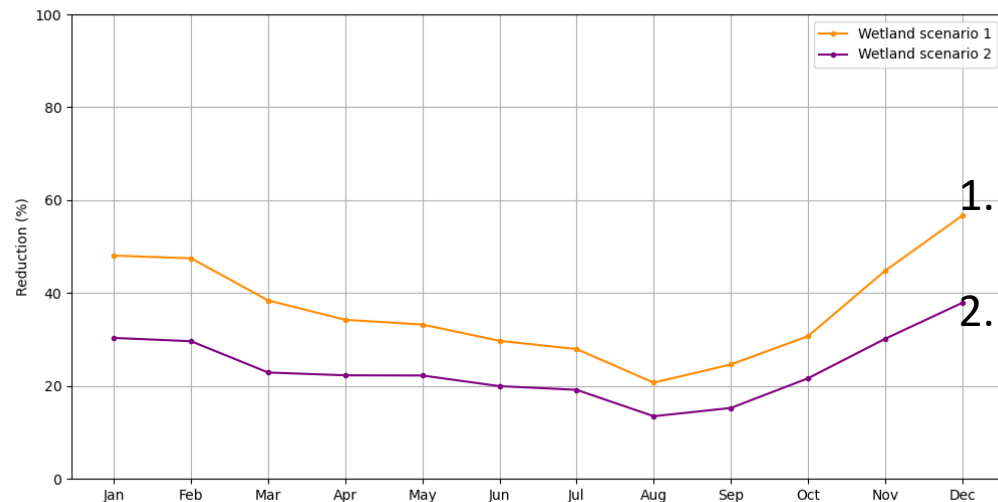
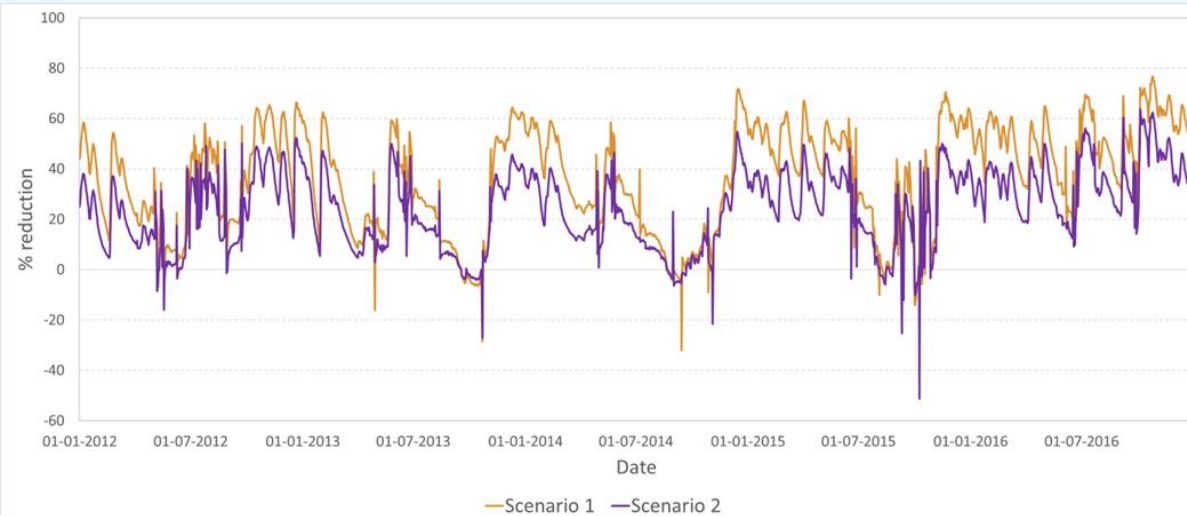

1. Optimistinen

2. Konservatiivinen

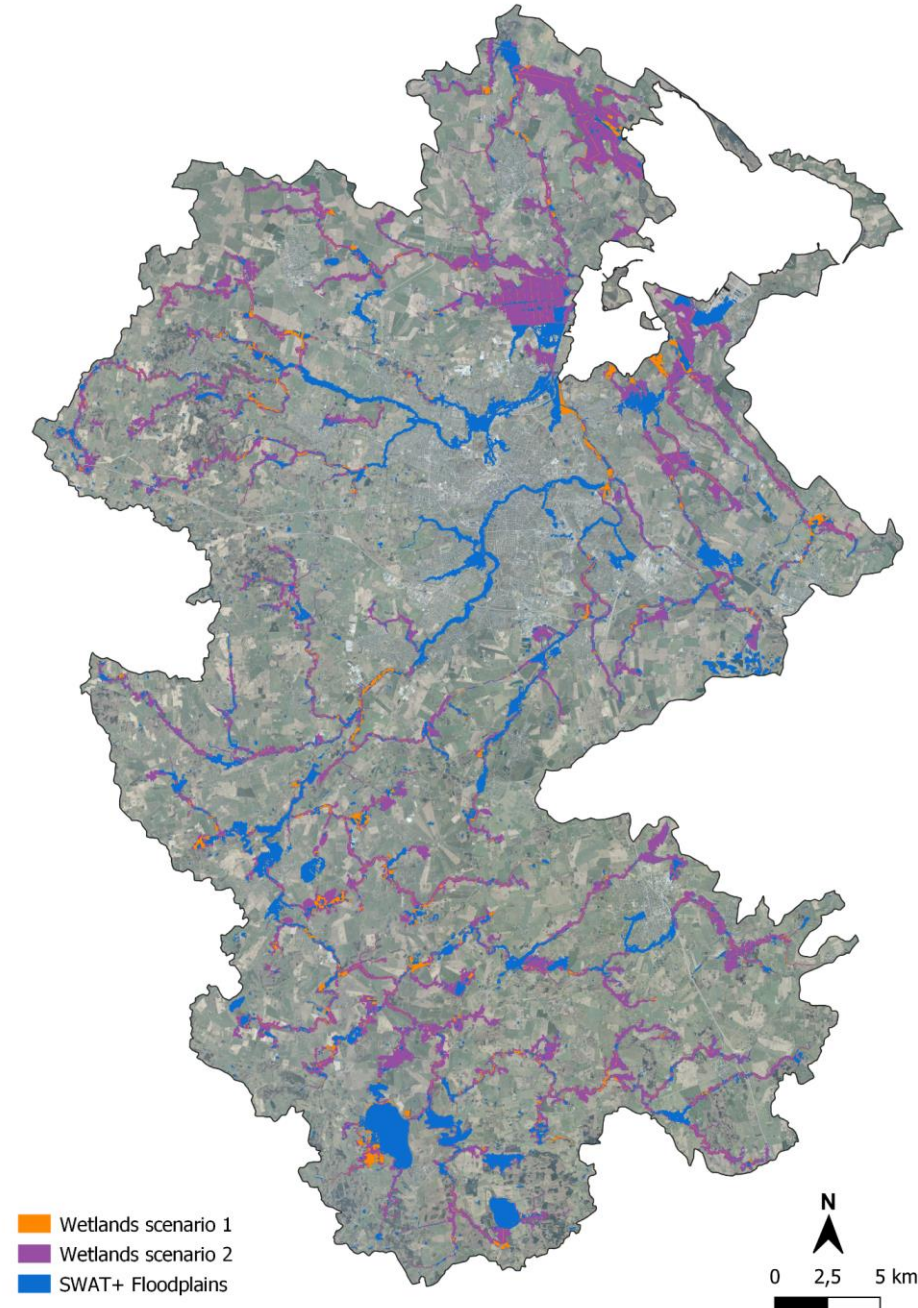

Mitkä menetelmät ovat mielestäsi tehokkaimpia ravinnekuormituksen vähentämiseksi?

Pelloilla tehtävät toimet

Kerääjä- ja aluskasvit

Kevennetty muokkaus ja suorakylvö

Maanparannusaineiden, kuten rakennekalkin ja kipsin

Lannoitteiden vähennetty käyttö

Metsittäminen

Kulkeuman hallinta

Ennallistetut kosteikot

Säätösalaojitus

Suojakaistat, joissa on ruohoa tai puita

Kasvipeite / ei maanmuokkausta alueilla, joilla tulva- ja/tai eroosioriski on suuri

Uomissa tehtävät toimenpiteet

Rakennetut kosteikot

Kaksitasouomat

Uomien mutkittelun palauttaminen

Laskeutusaltaat metsäalueilla

› Menti: join at [menti.com 13863868](https://menti.com/13863868)

NORDBALT-ECOSAFE

WP6 yhteiskunnan ohjauskeinot

Hannuksen Piilopirtti, Tyrnävä 14.10.2024

Anu Lähteenmäki-Uutela, Syke



Funded by
the European Union



Suomen ympäristökeskus
Finlands miljöcentral
Finnish Environment Institute

Vantaanjoki lähestyy hyvää tilaa

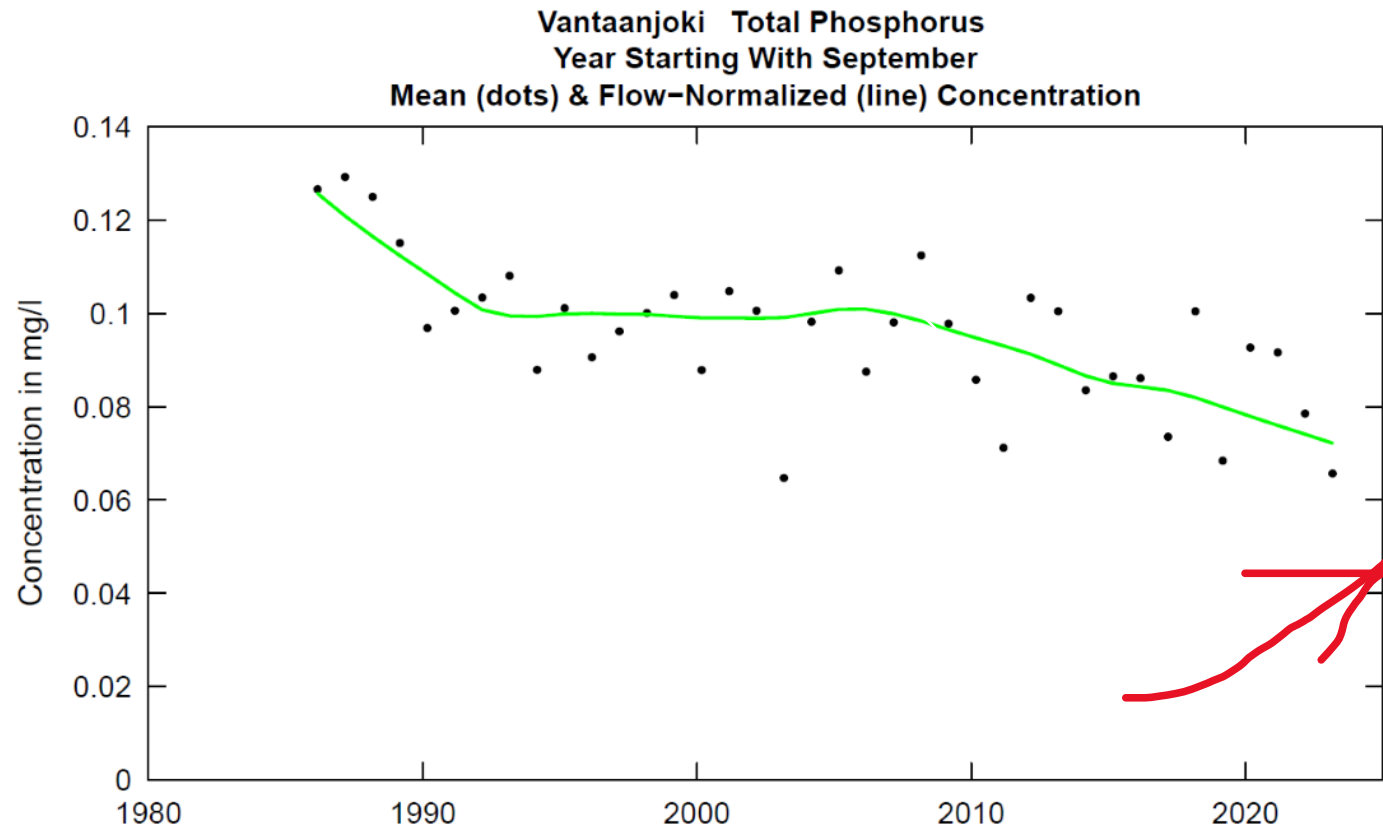
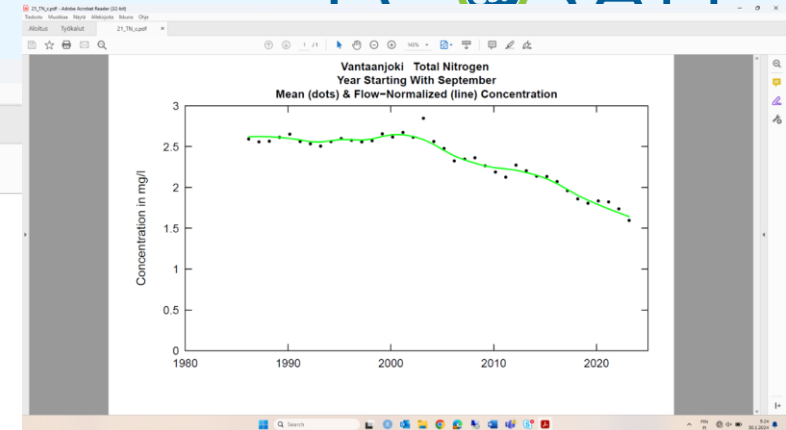

Vantaanjoki: taustaa

- **Muutoksia ja toimia:** peltoja otettu muuhun käyttöön, lannoitteiden käyttö vähentynyt, peltojen kipsikäsittely, talviaikainen kasvipeitteisyys, kosteikkoja rakennettu
- **Ohjauskeinoja:** lannoituksen sääntely, kipsihankkeet

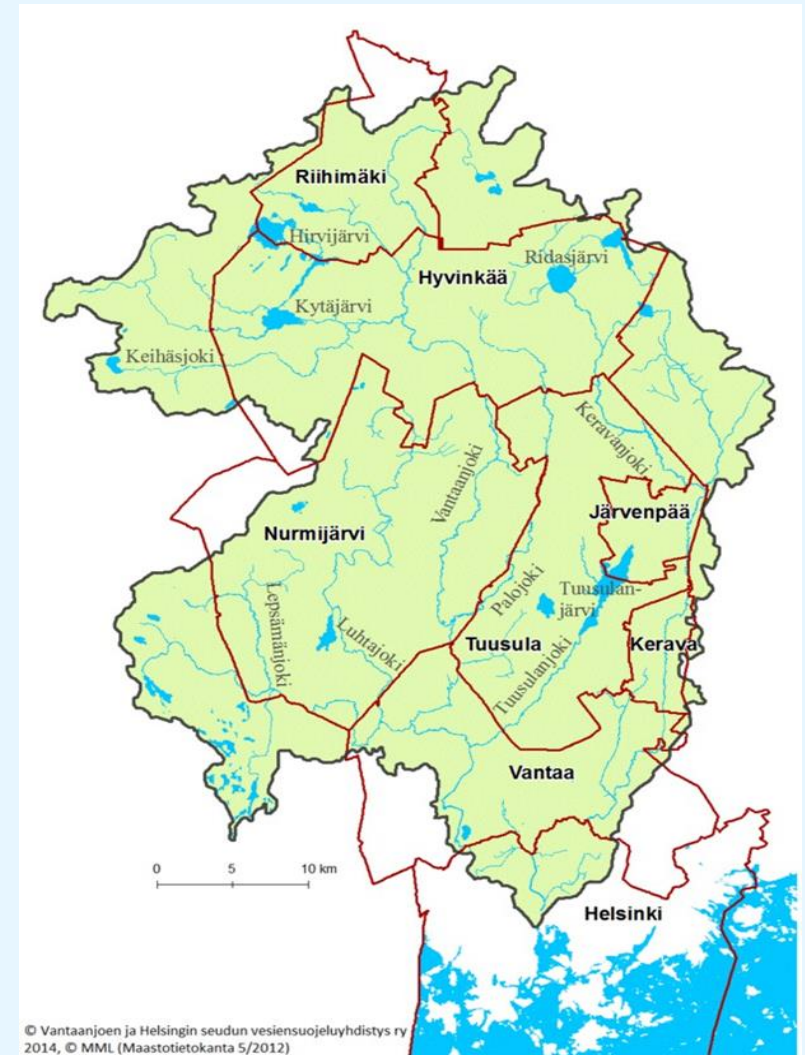

Norja: Morsa/Hobøl-joella fosfori alas

Ei syyskyntöä,
fosforilannoitteiden
käytön väheneminen,
suojakaistat, rakennetut
kosteikot,
ruohopeitteiset ojat

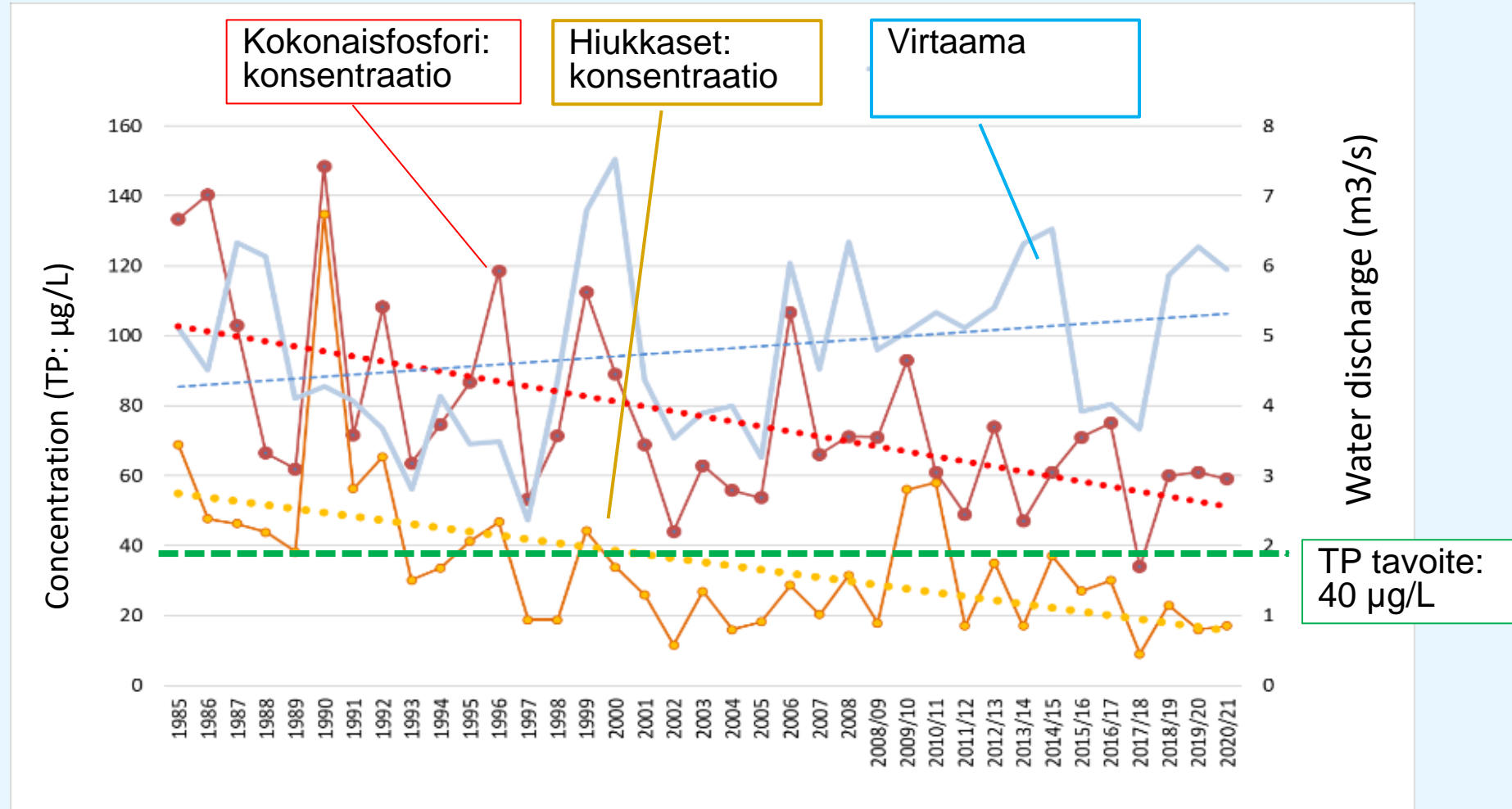

Morsa: ei syyskyntöä

2009: uusi laki: 60% maasta jätettävä
kyntämättä syksyllä

2013: laki kumottiin,
taloudellinen tuki väheni

2023: laki takaisin

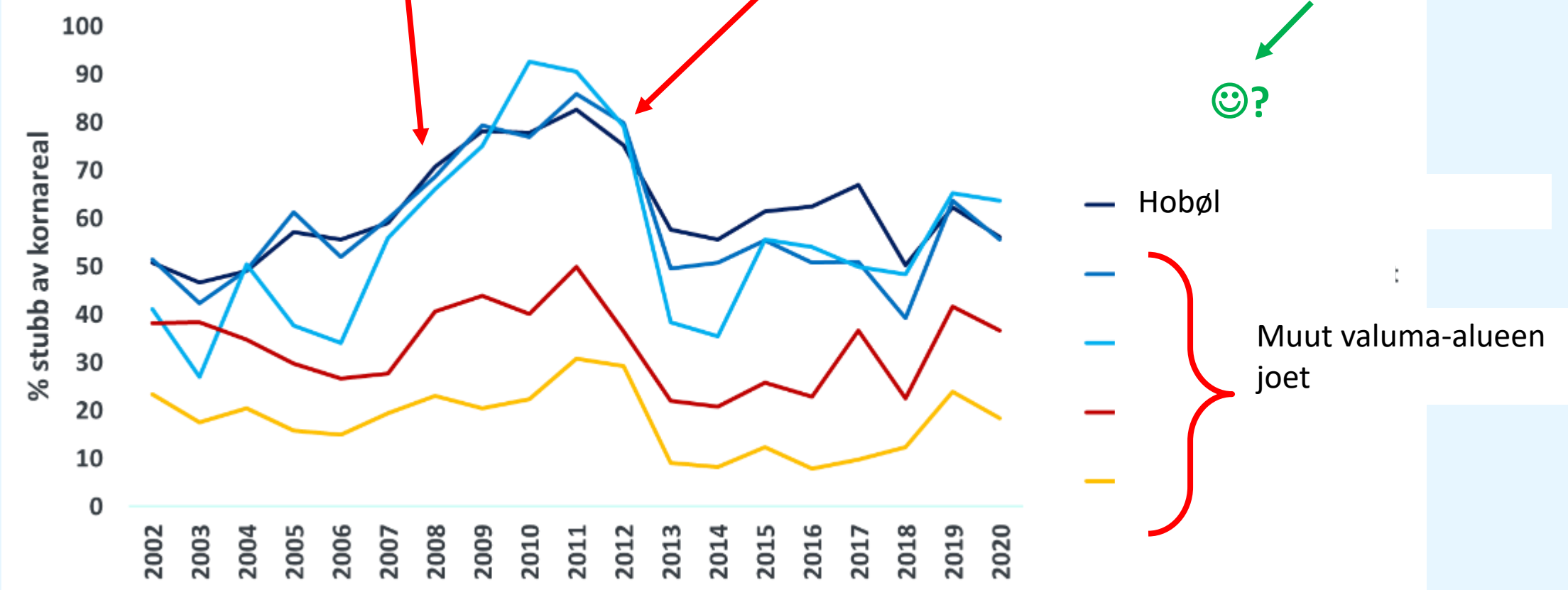

Tanska: Odense-joki paranee

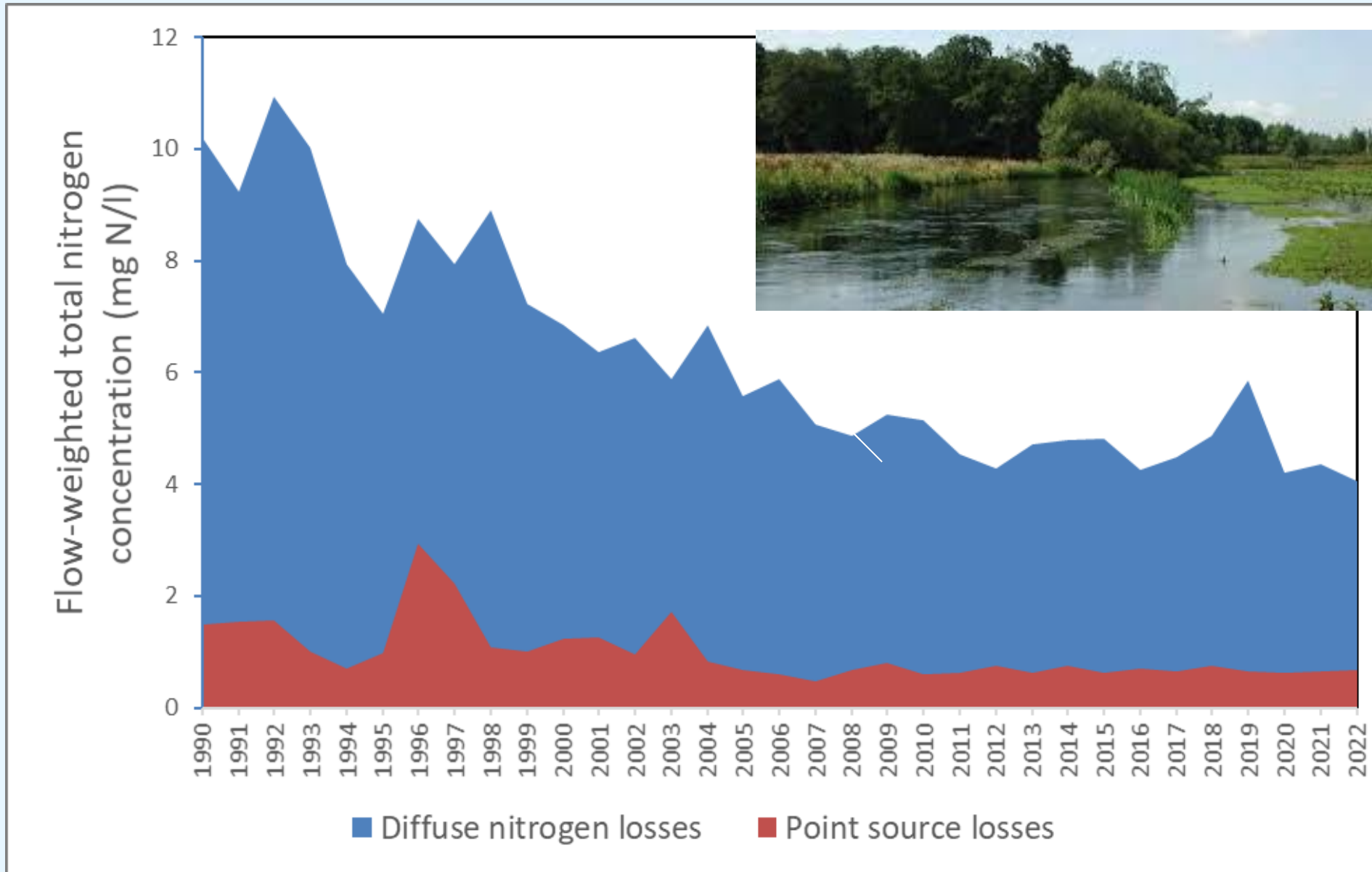

Tanska: Odense-joki

- nitraattidirektiivin toimeenpano: ympäristösuunnitelmat 1985, 1987, 1991: lannan hyödyntämisen säännöt (kemiallisten lannoitteiden käyttö -50%, typen hajakuormitus -40% vuoteen 2001)
- 1998: laaja kosteikkojen kunnostusohjelma (18.000 ha), lannoitteiden käytön vähentäminen, pakolliset kerääjäkasvit
- 2003: lannan hyödyntämisen lisääminen, kerääjäkasvit, kosteikot, metsittäminen
- 2016-2017: lannoitteiden käytön **säännöt pois**, kompensointina kerääjäkasvit ja kosteikot
- 2022-2027 tavoitteet: 15 % Tanskan maatalousmaasta metsäksi (250.000 ha), eloperäisille maille kosteikkoja (140.000 ha)

Puola: Słupia-joki, P ja N

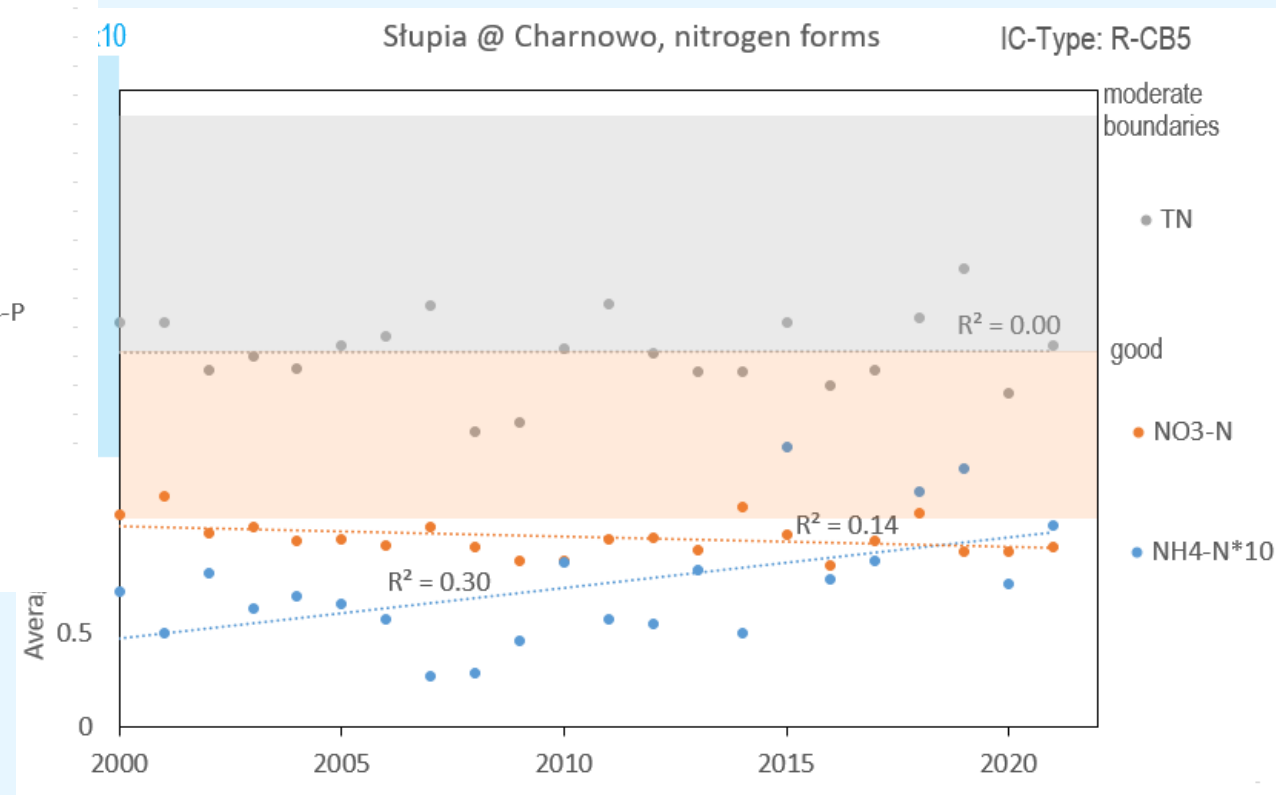
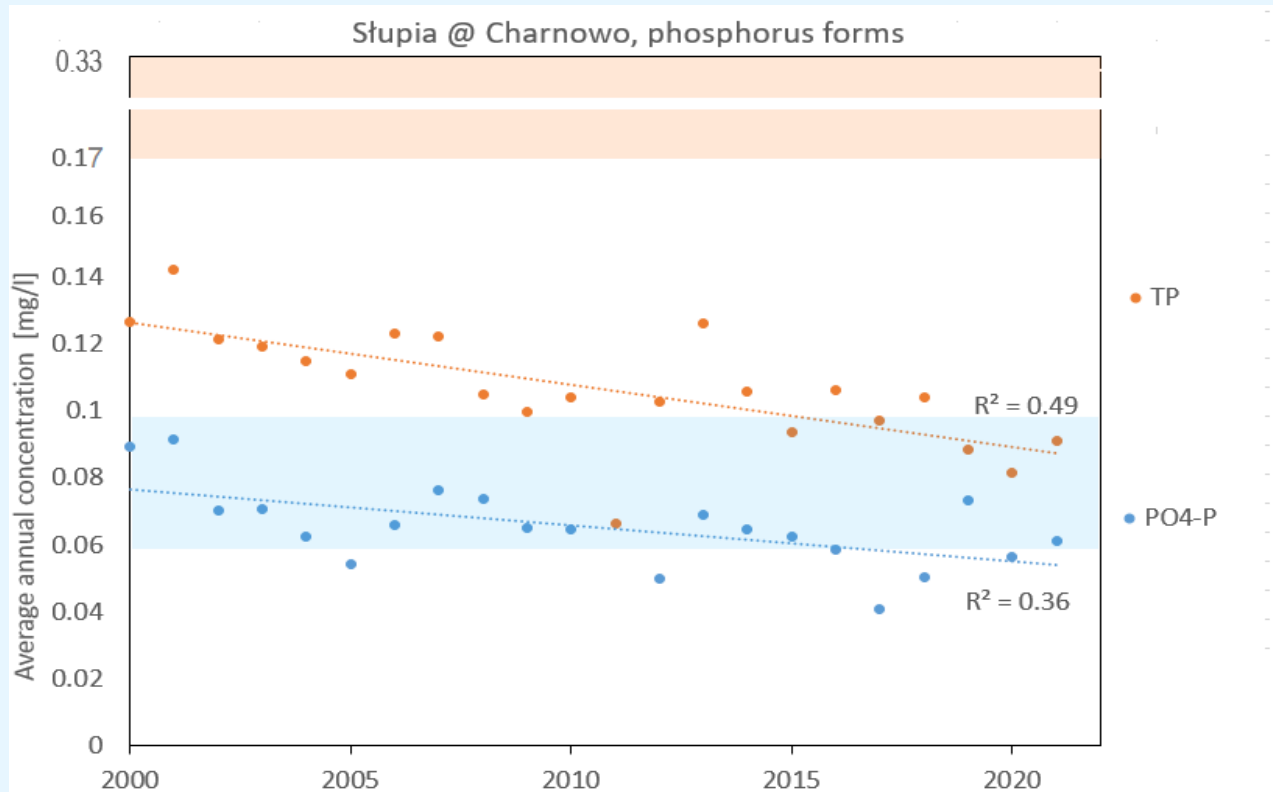

Puola:

- merkittävimmät fosforipitoisuuksien alenemat johtuvat kaupunkien jätevesien käsittelystä (ks. seuraava kalvo)
- EU:n pesuainesäätely 2005 vaikuttanut fosforikuormitukseen
- typpilannoitteiden käyttö **lisääntynyt**
- 2014-2020 lähtien metsittämistä ja suojakaistoja
- 2023 ympäristöjärjestelmät ravinnepäästöjen vähentämistavoitteet

Słupia-joen pistekuormitus alenee

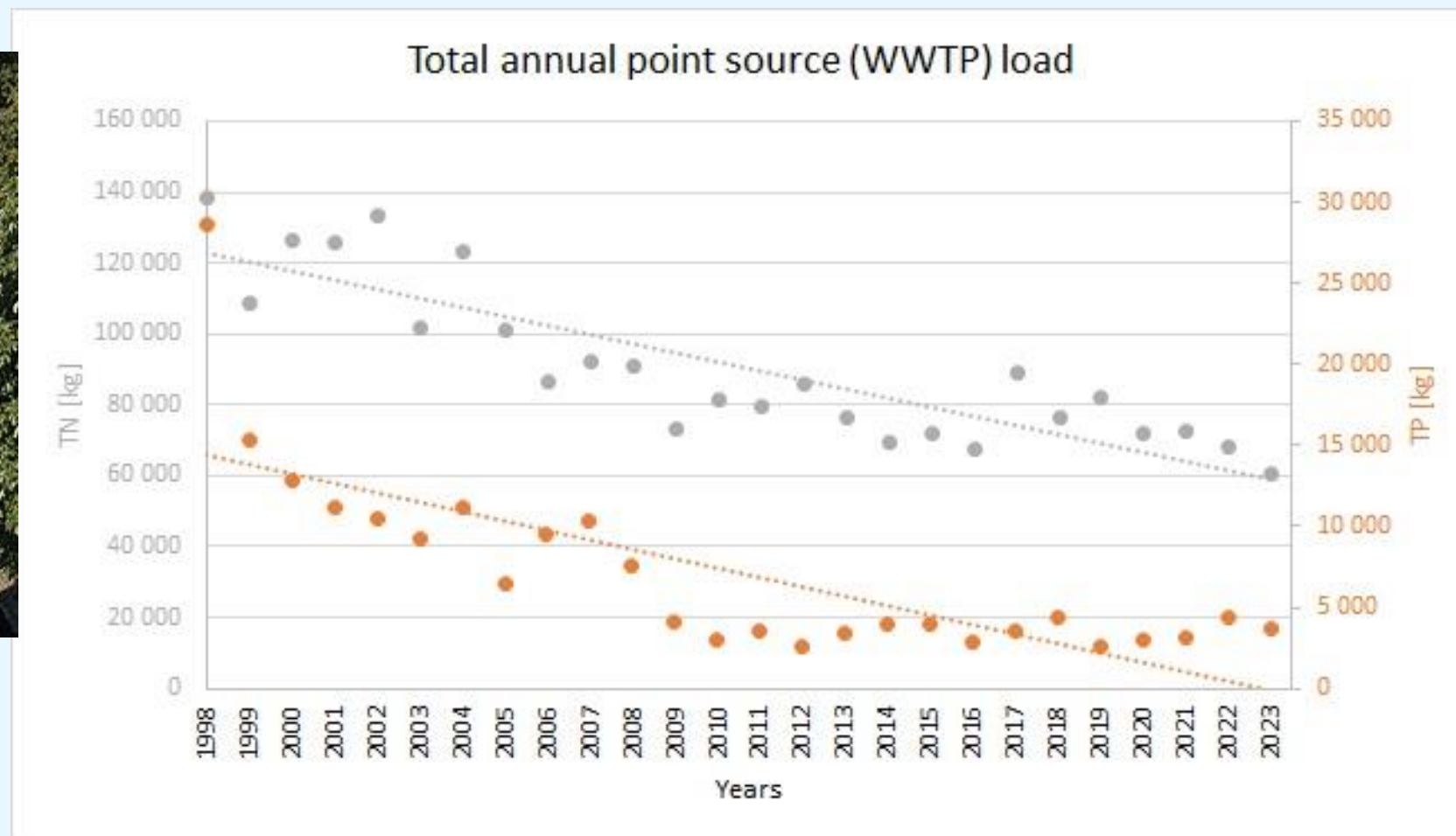

Johtopäätökset ja Menti-kysymykset

Ravinnekuormitus vähenee, kun vesiensuojelutoimia tehdään ja yhteiskunnan ohjauskeinoja käytetään.

- Mitä toimia pitäisi tehdä?
- Mitä ohjauskeinoja tulisi käyttää?

Maatalous osana valuma- aluelähtöistä vesienhallintaa

Markus Saari, POPELY

Valuma-alue

- Alue jolta jokin vesistö kerää vetensä
- Valuma-alueita on monen kokoisia ja tasoisia. Lähtökohtaisesti kaikille vesistöille voidaan määrittää valuma-alue.
- Mitä vedelle tapahtuu kun sitä tippuu taivaalta valuma-alueelle? Millaisen matkan se kulkee? Mitkä tekijät matkan varrella määrittelevät sen laatua ja liikettä? Mitä kaikkea se mahdollistaa matkallaan?
- Ihmistoiminta muuttanut valuma-alueita – ”Toimivatko” ne kunnolla? Onko liian märkää? Kuivaa? Voivatko eliöt hyvin?
- Voidaanko niiden toimintaa suunnitella ja ”korjata”? – Vesienhallintaa ja valuma-alue suunnittelua

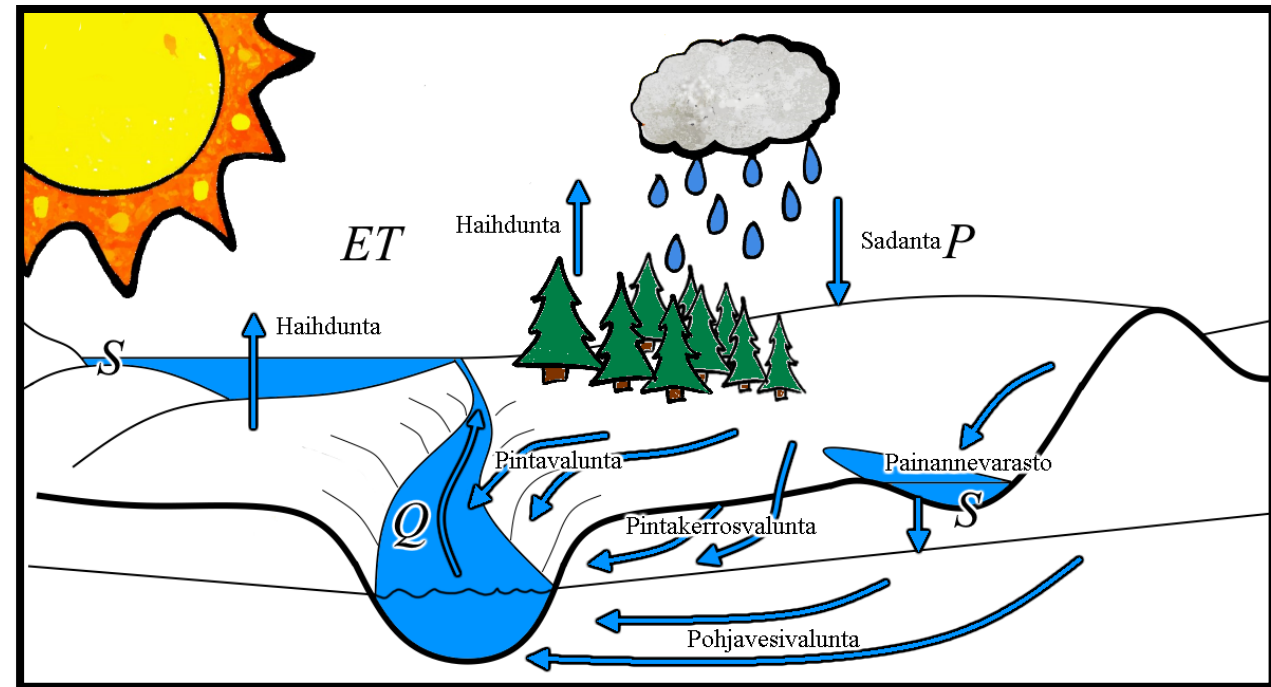

Vesienhallinta

- Vesienhallinnaksi voidaan lukea kaikki ne valuma-alueella tehdyt toimet, joiden tavoitteena on muuttaa veden liikettä ja vaikuttaa sen laatuun, määrään ja sijaintiin
- Vesienhallinnan määritelmä riippuu siitä, keneltä sitä kysyy
- Vesienhallintatoimella ja veden liikkeen ja sen luonteen muokkaamisella on aina jokin tarkoitus – Tämä voi olla esimerkiksi kuivatus maa- ja metsätalouden tuottavuuden nimissä tai vastaavasti vesiensuojelukosteikon perustaminen

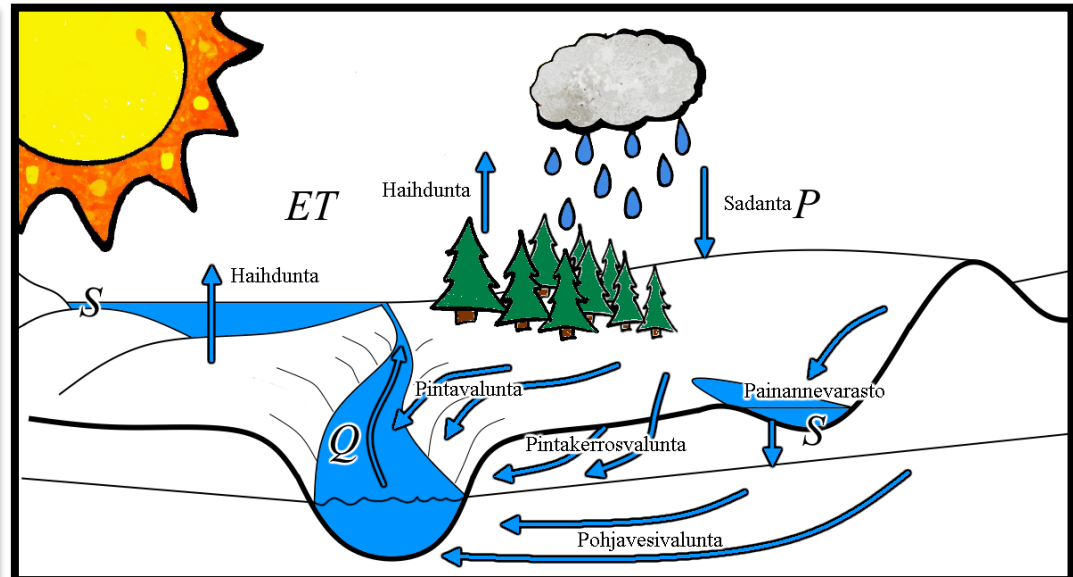

Valuma-aluelähtöisyys vesienhallinnassa

- Viime aikoina on enenemässä määrin tiedostettu valuma-aluelähtöisyyden merkitys kokonaisvaltaisessa vesienhallinnassa
- Valuma-aluelähtöisyys vesienhallinnassa edellyttää:
 - Hydrologisen kytkeytyneisyyden ja valuma-alueen toiminnan ymmärtämistä
 - Eri vedestä riippuvien ja veteen vaikuttavien toimien tunnistamista
 - Näiden toimien syy-seuraussuhteiden ymmärtämistä ja liittämistä tarkasteltavaksi valuma-alueen kokonaisuudeksi
- Valuma-alue lähtöisyys ei tarkoita sitä, että rajataan valuma-alue ja suunnitellaan toimia tämän rajatun alueen sisällä
- Parhaimmillaan valuma-alue suunnittelu ja valuma-alue lähtöinen vesienhallinta on monitavoitteista ja mahdollisimman kattavasti eri vesiin liittyvät toimijat ja niiden tarpeet huomioivaa – Ilmastonmuutos, monimuotoisuus, veden riittävyys ym.
- Vaatii laaja-alaista osaamista

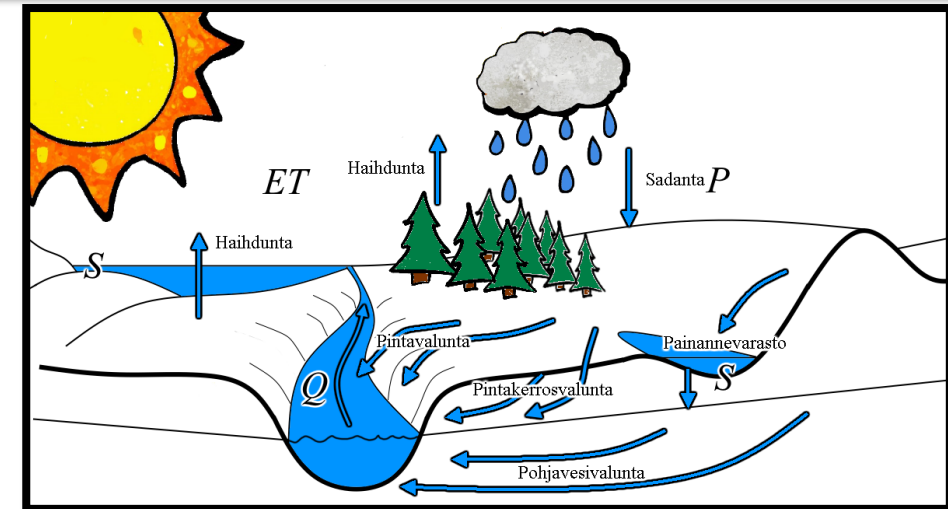

Valuma-aluelähtöisyys käytännössä

- Valuma-aluelähtöisellä vesienhallinnalla ei ole vakiintuneita käytänteitä, koordinaatiota sekä tietovarannot ja rahoituskanavat ovat osin hajallaan – Tämän vuoksi valuma-aluelähtöinen toteuttaminen vesienhallinnassa on yleistynyt hitaasti
- Käsitteet ja termien käyttö usein kirjavaa
- Maa- ja metsätalouden vesienhallintaa on pyritty edistämään viime vuosina MMM:n ja YM:n rahoittamilla hankkeilla sekä YM:n valuma-aluepiloteilla
- Hankkeiden toimet voimakkaasti vesistöjen tilaan ja niiden kunnostukseen kytkeytynyttä – Tässä kehityttyä ja tietoisuus valuma-aluelähtöisestä lähestymistavasta lisääntynyt

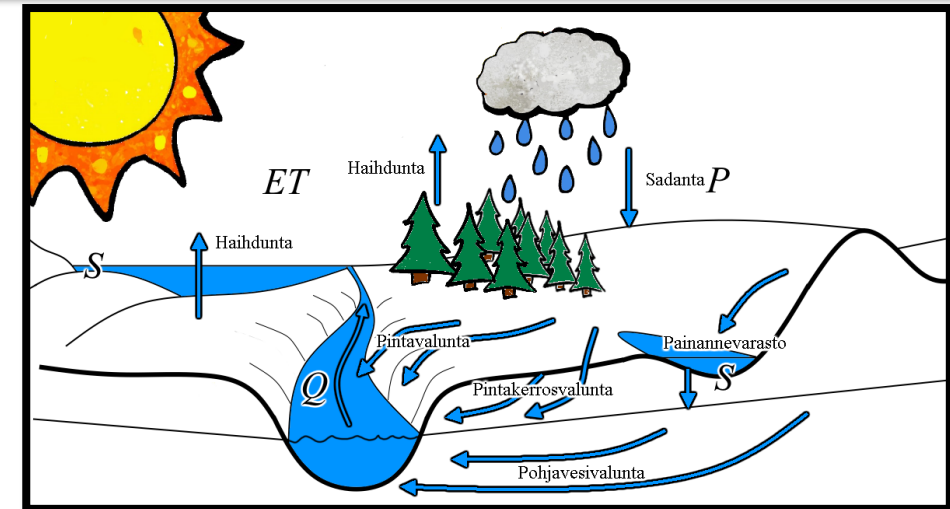

Valuma-alueelähtöisyys käytännössä

- Kohteiden ja toimenpiteiden priorisointia, aineistopohjaista analysointia ja kokonaisvaltaisempaa tekemistä
- Toimijaverkostot kehittyneet paljon
- Yleensä kaksi lähestymistapaa: Maanomistaja- tai vaikuttavuuslähtöistä
- Useimmiten näistä valitaan maanomistajalähtöisyys – Hankemuotoinen toiminta ohjaa vahvasti toimintamalleja
- Valuma-alueelähtöisyyttä pyritty sisällyttämään myös vesien- ja merenhoidon toteutuksiin
- Valuma-aluesuunnittelun tiekartta

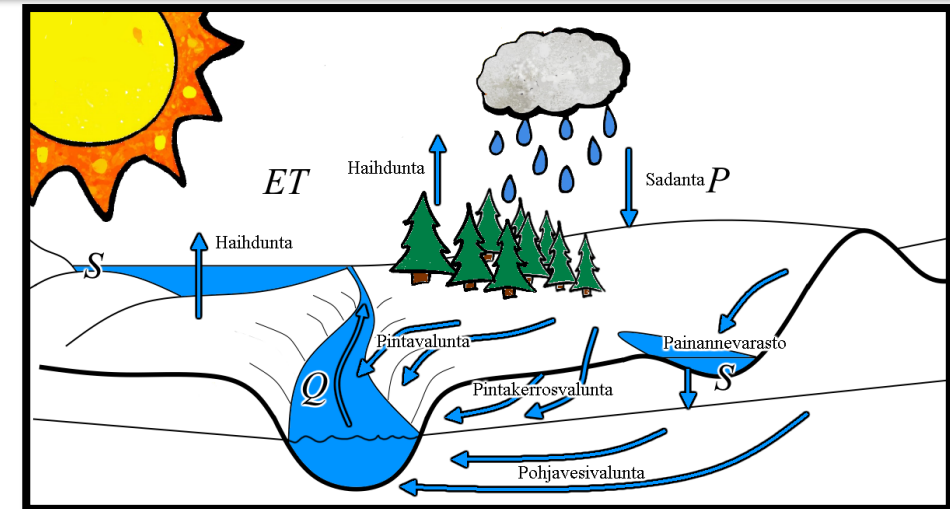

Mitä seuraavaksi?

- Pullonkauloihin puuttuminen
 - Koordinaatio
 - Resurssit
 - Tiedot ja taidot

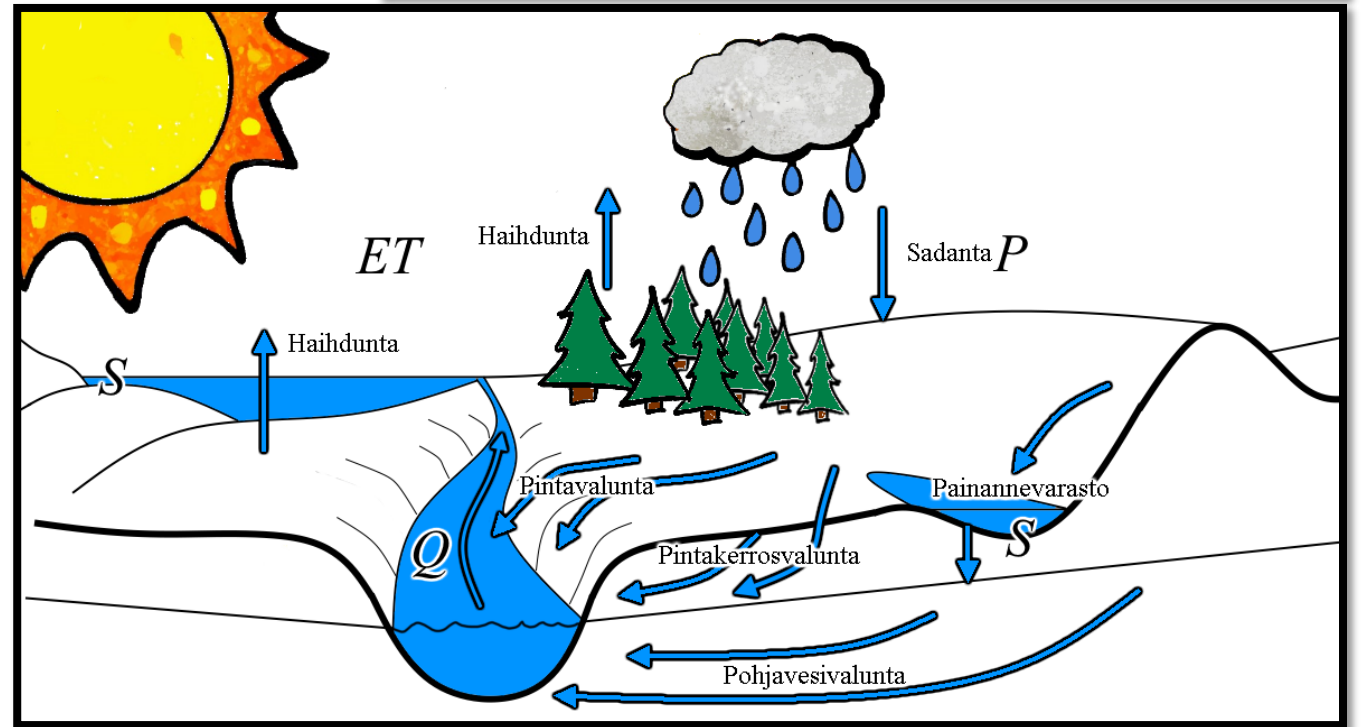
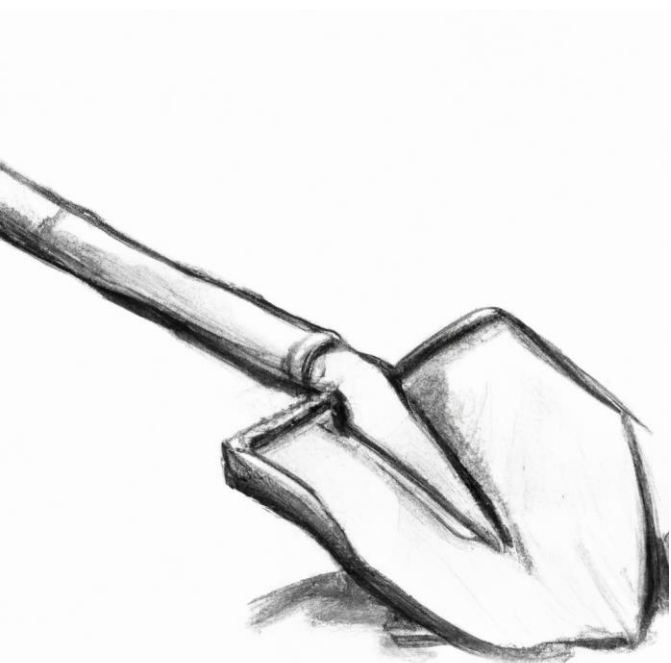

Maatalous osana vesienhallintakokonaisuutta

- Vesienhallinnan näkökulmasta maatalous on hyvin intensiivinen maankäyttömuoto
- Sillä on niin valuma-alueisiin ja niiden vesiin liittyviä tarpeita kuin vaikutuksiakin
- Vesienhallinta on oleellinen osa maataloutta
 - Pellon kasvukunto – Onko vettä tarpeeksi vai liikaa?
 - Kuormitus – Minkälaista vettä maatalousalueelta valuu vesistöihin? Viljelykäytäntöjen vaikutus?
 - Ilmastovaikutus – Veden pinnan säätely? Hiilensidonta?

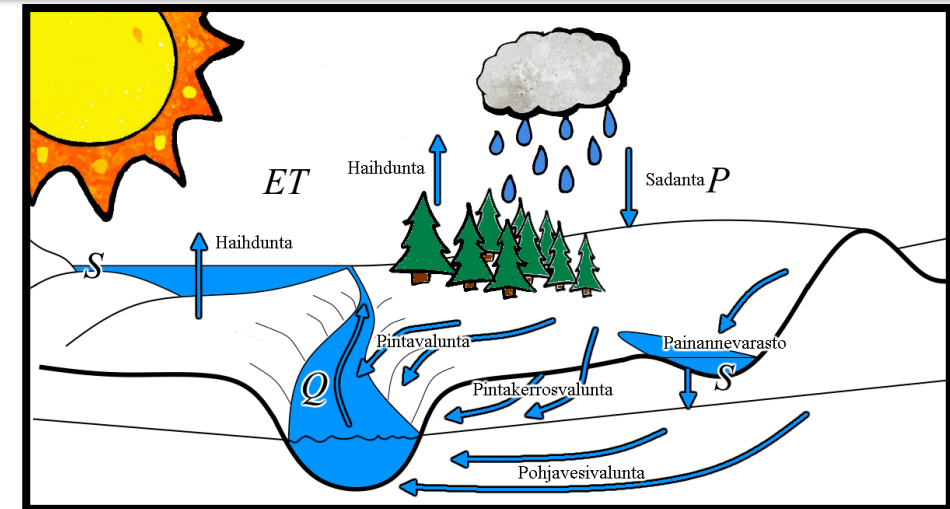

Maatalous osana vesienhallintakokonaisuutta

– Vesien määrällinen hallinta

- Laajamittainen kuivatus ollut pakollista viljelyn mahdollistamiseksi monilla alueilla
- Muu valuma-alueiden maankäyttö (esim. metsätalous) sekä runsas ojitus korostavat veden poistumista valuma-alueilta entisestään – Valuma-alueiden vedenpidätyskyky?
- Tämä yhdistettynä sääolojen äärevöitymisen lisääntymiseen on johtanut siihen, että maatalouden toimintaolosuhteet vuoristorataa

30.5.2024

yle

Maatalous

Kesä tuli äkkiä ja toi kylvösäät – nyt pelloille kaivataan kiireesti jo vettä

Pirkanmaan tilanne on samankaltainen kuin koko Etelä-Suomen. Paikoin on tullut sadekuuroja, mutta laajalti itämisen kannalta on jo kuivaa.



Veden riittävyys – Mikä neuvoksi?

- Miten voidaan varmistaa, että vettä on tarjolla riittävästi ja oikeaan aikaan?
- Toimet maatalousympäristössä – Pumppaus? Veden varastointi? Kastelujärjestelmät? Automaatio?
- Toimet valuma-alueilla – Vesien viivyttäminen ja valuma-alueiden vedenpidätyskyvyn parantaminen
- Haasteellista teknisesti ja kaikin muin mahdollisin tavoin – Vaatii usein kokonaisvaltaista suunnittelua ja eri tahojen osallistamista ympärivaluma-aluetta



Veden riittävyys – Käytännön esimerkkejä

- Ruukin tutkimusaseman koepellot ja veden varastoallas
- Turvepelto, happamat sulfaattimaat, pohjoinen maatalous
- Varastointiallas kerää yläpuolisen valuma-alueen vettä ja se on kytketty säätökastelujärjestelmään
- Tarkoituksena kokeilla viljelyä korotetulla pohjaveden pinnalla (30 cm maanpinnasta)
- Tarkastellaan lohkoakohtaisesti vesistökuormitusta ja kasvihuonekaasupäästöjä

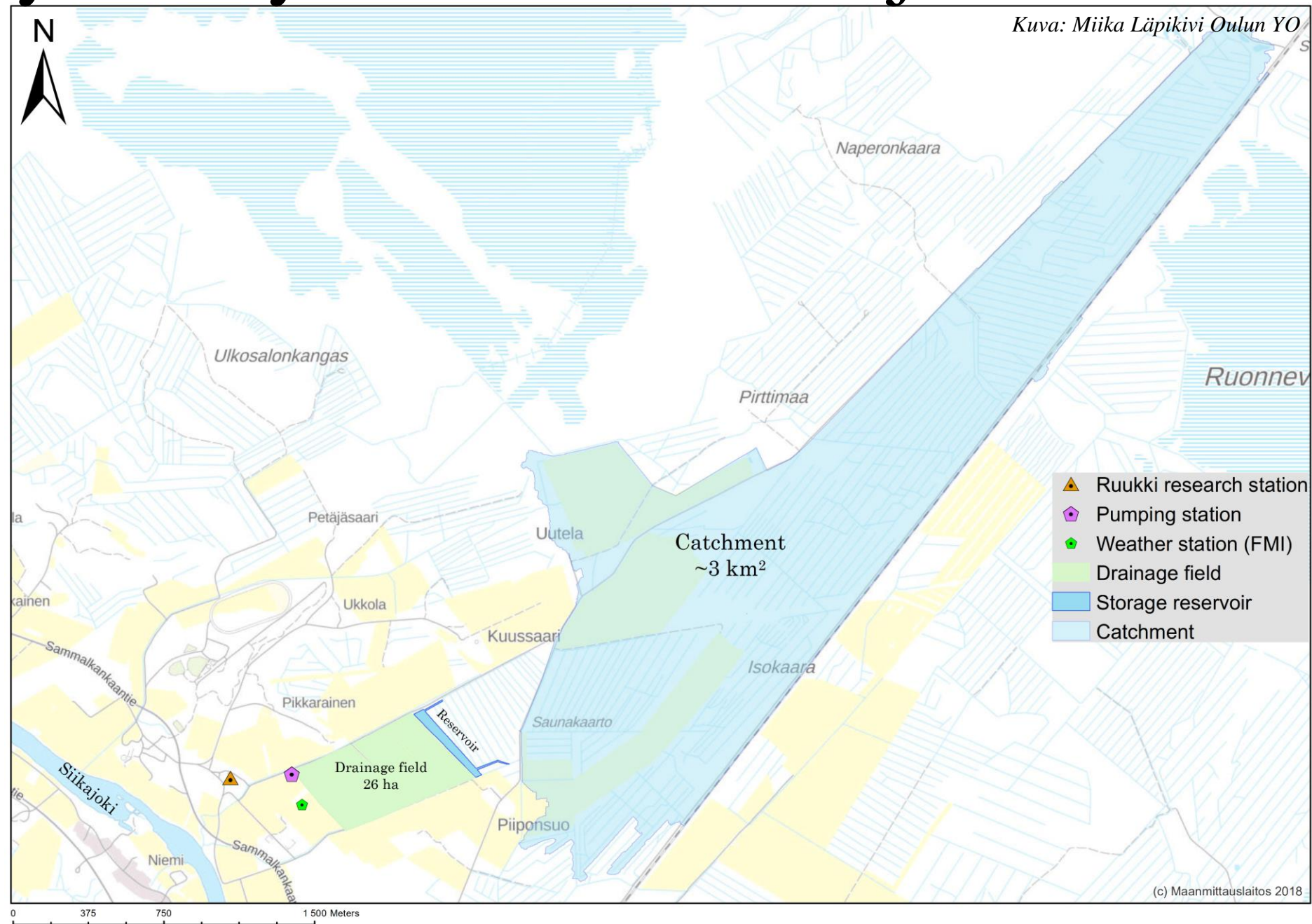

Ruukki

*Lisätietoja:
Maarit Liimatainen LUKE
Miika Läpikivi Oulun yliopisto*



Mitä täytyy huomioida veden varastoinnissa?

- Mitkä ovat edellytykset veden varastointiin? Millaiset mahdollisuudet yläpuolinen valuma-alue tarjoaa? Onko vettä tarjolla tarpeeksi? Voidaanko valuma-alueella tehdä toimia sen soveltuvuuden parantamiseksi? Veden viivyttäminen?
- Mitä vaikutuksia kastelulla on? Tarvitaanko lupia? Kastuuko naapurit?
- Miten huolehditaan tekniikasta?
- Miten todennetaan korkea pohjaveden pinta?
- Vedenlaatu?
- Tuet?

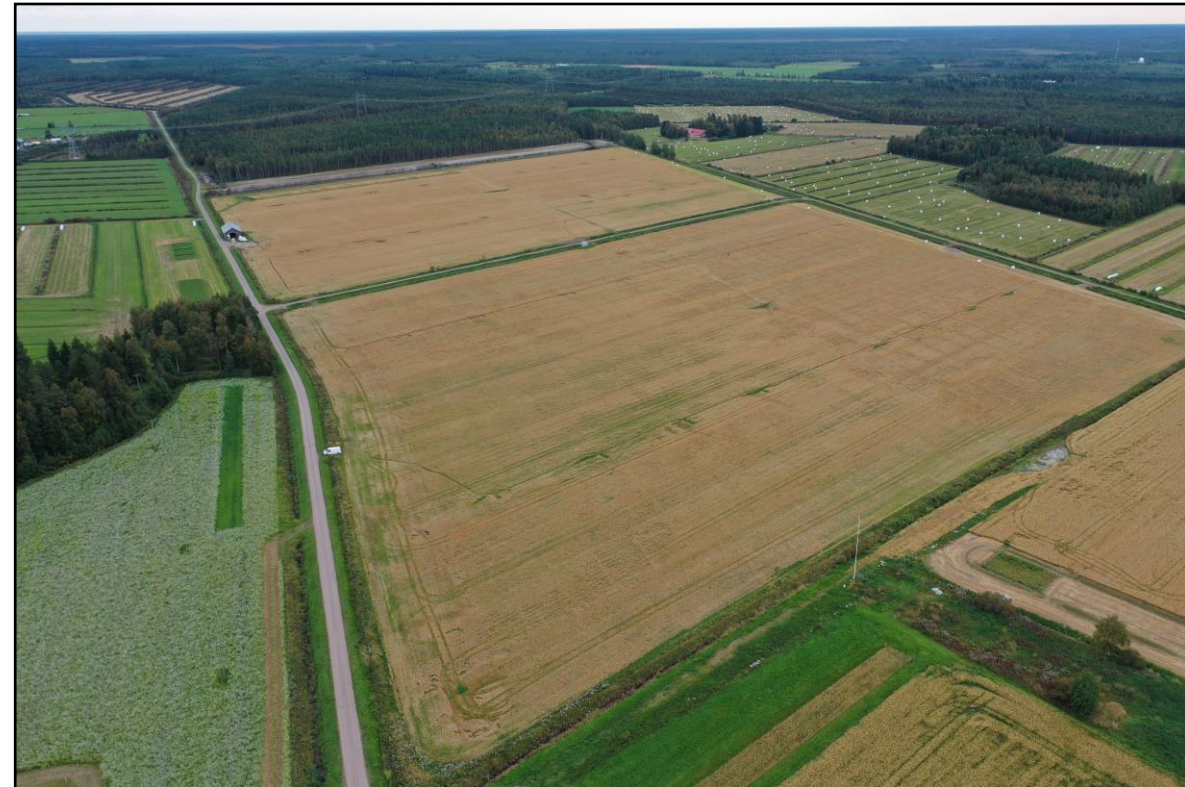

Tiedoksi

Suomessa on ollut 2000-luvulla kaksi vakavaa kuivakautta

Kuivuus on globaalisti yksi tuhoisimmista luonnonkatastrofeista. Vaikka Suomessa on runsaat vesivarat, ei Suomikaan ole turvassa kuivuuden vaikutuksilta.

Suomessa on 2000-luvulla koettu kaksi vakavaa kuivakautta, vuosina 2002–2003 sekä vuonna 2018. Näiden lisäksi viimeisen viiden vuoden aikana, vuosina 2019 ja 2023, on ollut hyvin kuivia kausia.

Vuoden 2018 vakava kuivuus oli kesällä ja aiheutti joidenkin arvioiden mukaan yli 400 miljoonan euron tappioita maataloussektorille. Hallitus antoi tuolloin 86,5 miljoonan euron tukipaketin maataloudelle kuivuuden johdosta.

Ilmastonmuutos kasvattaa kasvukauden pituutta, mutta samalla kasvaa haihdunta ja kuivat kaudet. Tämä tarkoittaa sitä, että jos maatalous ei pysty sopeutumaan ilmastonmuutokseen, ei pidemmästä kasvukaudesta ole hyötyä.

Valuma-alue suunnittelun tiekartta



Tavoite 1 – ”prosessi”

Valuma-alue suunnittelu on vakiintunut toimintatapana. Valuma-alue suunnitelmia laaditaan tarvelähtöisesti ja ne ohjaavat käytännön toimia.



Tavoite 2 – ”työkalut ja osaaminen”

Valuma-alue suunnittelun osaaminen on kasvanut. Kattavat tietovarannot ja suunnittelutyökalut ovat kaikkien toimijoiden käytössä.



Tavoite 3 – ”ohjaukset”

Ohjaukset ja rahoitusvälineet mahdollistavat toimien kustannustehokkaan, oikeudenmukaisen ja monitavoitteisen kohdentamisen ja toteutuksen valuma-alueella.



- [Valuma-alue suunnittelun tiekartta vuoteen 2030 - Valto \(valtioneuvosto.fi\)](#)

Suomen ympäristökeskuksen raportteja 17 | 2024

Monitavoitteinen valuma-alue suunnittelu

Yhteenveto ohjeista, oppaista, tietotuotteista ja hankkeista

Mika Marttunen, Teija Rantala, Miika Kajanus, Ville Turunen, Satu Virkkumaa, Marko Häkkinen, Pihla Seppälä, Aleksi Räsänen



[Monitavoitteinen valuma-alue suunnittelu : Yhteenveto ohjeista, oppaista, tietotuotteista ja hankkeista \(helsinki.fi\)](#)

Kiitos

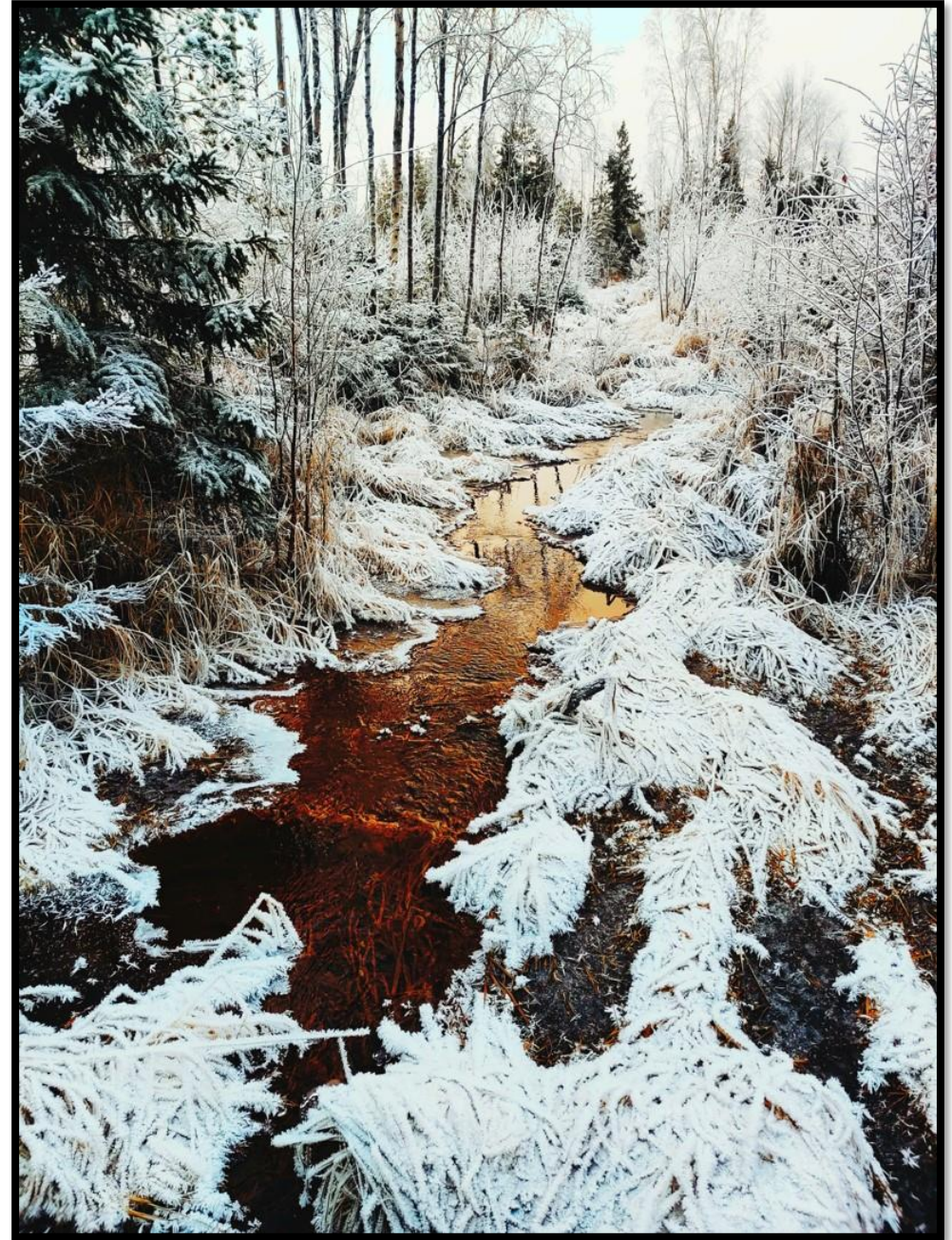



Maaseutuhallinnon Tyrnävän yhteistoiminta-alue

- Vuoden 2013 alusta aloittaneen maaseutuhallinnon yhteistoiminta-alueen muodostavat Hailuodon, Kempeleen, Limingan, Lumijoen, Muhoksen ja Tyrnävän kunnat.
- Maaseututoimistot ovat Tyrnävällä ja Muhoksella. Tyrnävän maaseututoimistolta annetaan palvelua viikoittain, Hailuodossa, Limingassa ja Lumijoella.
- 3 maaseutuasiamiestä
 - 493 aktiivitilaa
 - 40 228 ha viljelyksessä
 - Yleisimmät viljelykasvit
 - Rehunurmi n. 12 264ha
 - Kaura n. 6 478ha
 - Rehuohra 6 135ha
 - Karjatiloja 84 kpl, joista lypsykarjatiloja 47

Lukuja Tyrnävän maataloudesta

- 123 aktiivitilaa
- Peltoa viljelyksessä n. 11 131ha tilojen keskipinta-ala n. 90,5oha
- Viljan viljelyala on n. 4.139 ha josta on ohraa 2.140 ha ja kauraa 1.656ha
- Valkuais- ja öljykasveja viljellään yhteensä n. 977 ha
- Nurmiviljelyssä on 2.918 ha
- Perunaa on viljelyksessä yhteensä 1.317 ha
 - Siemenperunaa 638 ha
 - Ruokaperunaa 534 ha
 - Ruokateollisuusperunaa 147 ha
- Karjatiloja on yhteensä 13, joista lypsykarjatiloja 11

Ajankohtaista syksyllle 2024

- Älä levitä lannoitteita koskaan lumipeitteiseen, routaantuneeseen tai veden kyllästämään maahan
- Älä levitä lantaa tai orgaanisia lannoitevalmisteita 1.11.-31.3. välisenä aikana
 - voi poiketa levittämisen kieltoajasta marraskuun loppuun poikkeuksellisen sääolosuhteen vuoksi, näissä erityistapauksissa on aina tehtävä ilmoitus ympäristönsuojeluviranomaiselle lokakuun loppuun mennessä.
- 15.9. alkaen lannan voi levittää vain sijoittamalla tai hajalevityksellä jos lanta mullataan vuorokauden sisällä levityksestä



Ajankohtaista syksyille 2024

- Talviaikainen kasvipeitteisyys (ehdollisuus)
 - Viljelijätukien perusehto
 - Pellon ja pysyvien kasvien alasta vähintään 33 prosenttia pitää olla kasvipeitteistä talvikaudella (30.10.2024-15.3.2025). Vaatimusta ei voi täyttää pysyvän nurmen alalla.
 - Hyväksytään myös kevyesti muokattu ala, esim. Lautasäkeellä kertaalleen ajettu ala
 - Ei makseta erillistä korvausta



Ajankohtaista syksyllle 2024

- Ekojärjestelmätuen talviaikainen kasvipeitteisyys
 - Viljelijälle vapaaehtoinen, maksetaan korvausta n. 50€/ha
 - Alan tulee olla muokkaamatonta 31.10.2024-15.4.2025
 - Pysyvän nurmen tulee olla muokkaamatonta 31.10.2024-1.5.2025
 - Maksetaan myös korvauskelvottomalle alalle jos se on otettu käyttöön viimeistään vuonna 2022

- Alat joita ei voi ilmoittaa; kevytmuokattu ala, suojavyyhyke- ja turvepeltojen nurmet, sänki- ja avokesanto, kasvijäte, kasvimaa, peruna, porkkana, sipuli yms.



Ajankohtaista syksyille 2024

- Syysilmoitus, arvioitu aika 7.1.-4.2.2025
 - Talviaikainen kasvipeite**; ehdollisuuden vähimmäismaanpeitevaatimus ja ekojärjestelmätuen talviaikainen kasvipeitteisyys
 - Kiertotalouden edistäminen**
 - Käytetyt kasvinsuojeluaineet** (luomu ja puutarhakasvien vaihtoehtoisen kasvinsuojelun toimenpiteeseen ilmoitetut alat)
 - Valumavesien hallinta**
 - Lintupellot**



Ajankohtaista maaseutuhallinnossa

- Peltotukihaun muutos aika päättyi 2.10.2024
- Peltotukihakemukselle muodostuneiden tarkisteiden käsittely
- Tarkisteisiin liittyvien selvityspyyntöjen pyytäminen



Tavoitteellinen maksuaikataulu 2024, peltotuet

Marraskuu

- Ympäristökorvaus, maksuprosentti 85%

Joulukuu

- Luonnonhaittakorvaus, maksuprosentti 95%
- Perustulotuki, maksuprosentti 95%
- Ekojärjestelmätuki, maksuprosentti 95%
- Uudelleenjakotulotuki, maksuprosentti 95%
- Nuortenviljelijöiden tulotuki, maksuprosentti 95%
- Kansalliset peltotuet, maksuprosentti 100%



Yhteystiedot

Hanna Marttinen

Vs Maaseutupäällikkö

p. 044 2559885, hanna.marttinen@tyrnava.fi

Jonna Roininen

Maaseutuasiamies

p. 040 356 3109, jonna.roininen@tyrnava.fi

Ari Kauppi

Maaseutuasiamies

p. 040 8361001, ari.kauppi@tyrnava.fi





Spotkanie dyskusyjne, 22 stycznia 2025, Słupsk

Jak poprawić jakość wód w zlewni Słupi? Wyniki projektu NORDBALT ECOSAFE

Spotkanie odbędzie się w środę **22 stycznia 2025r.** w siedzibie **Słupskiego Inkubatora Technologicznego przy ul. Portowej 13B w Słupsku**. Będziemy zobowiązani za potwierdzenie udziału w spotkaniu (Marek Giełczewski, 505 987 873, marek_gielczewski@sggw.edu.pl) do dnia **17 stycznia 2025r.**

Wstępny program spotkania

- | | |
|-------------|---|
| 9:00-9:15 | Przywitanie uczestników, <i>kawa</i> |
| 9:15-9:30 | Ustalanie stężeń referencyjnych biogenów dla wód śródlądowych w celu ochrony bioty |
| 9:30-9:45 | Monitoring ciągły jakości wód powierzchniowych |
| 9:45-10:00 | Przykłady wdrażania polityk dotyczących działań ochronnych z krajów regionu Morza Bałtyckiego |
| 10:00-10:20 | Budowa narzędzia do symulacji efektywności działań ochronnych w zlewni Słupi (model SWAT+) |
| 10.20-10.40 | <i>Przerwa kawowa</i> |
| 10:40-11:00 | Propozycja katalogu działań ochronnych dla zlewni Słupi |
| 11:00-11:20 | Wstępne wyniki modelowania efektywności wybranych działań ochronnych |
| 11:20-12:00 | Dyskusja na temat kryteriów wyboru i lokalizacji działań ochronnych oraz ich efektywności |
| 12:00-12:10 | Podsumowanie spotkania |
| 12:10-13:00 | <i>Obiad</i> |



Spotkanie dyskusyjne / Stakeholders Meeting

Stupsk, 22 styczeń/January 2025

Lista uczestników - List of participants

Nr No.	Imię i nazwisko Name and surname	Instytucja Institution	Podpis Signature	Kontakt (mail) Contact
1.	Małgorzata Błaszczak	WODOCIĄG STUPSK	MBS	m.warowska@wodociagstupsk.pl
2.	Robert Zmuda-Turkiewicz	WODOCIĄG STUPSK	R. Zmuda	v.zmuda@wodociagstupsk.pl
3.	Justyna Ciolek	Ośrodek Doradztwa Rolniczego Stupsk	Ciolek	ichodak@poczta.pl
4.	Marek Ganiol	Ośrodek Doradztwa Rolniczego Stupsk	Ganiol	m.ganiol@poczta.pl
5.	Céline Jordanville	WODY POLSKIE NA STUPSK	Cy	celine.jordanville@wody.gov.pl
6.	Anne Jorvais	Ministerstwo Rolnictwa i Środowiska	Anne Jorvais	anne.jorvais@poczta.pl
7.	Katarzyna Kowalska	"WODOCIĄG STUPSK"	Kowalska	k.kowalska@wody.gov.pl
8.	Jakub Denis	W	Jakub Denis	j.denis@wody.gov.pl
9.	Anna Namonić	G101	Nas	a.namonic@wody.gov.pl
10.	Tom Kofel	G101	Tom Kofel	t.kofel@wody.gov.pl
11.	Piotr Baryk	G101	Piotr Baryk	p.baryk@wody.gov.pl
12.	Szymon Zmuda	G101	Szymon Zmuda	s.zmuda@wody.gov.pl

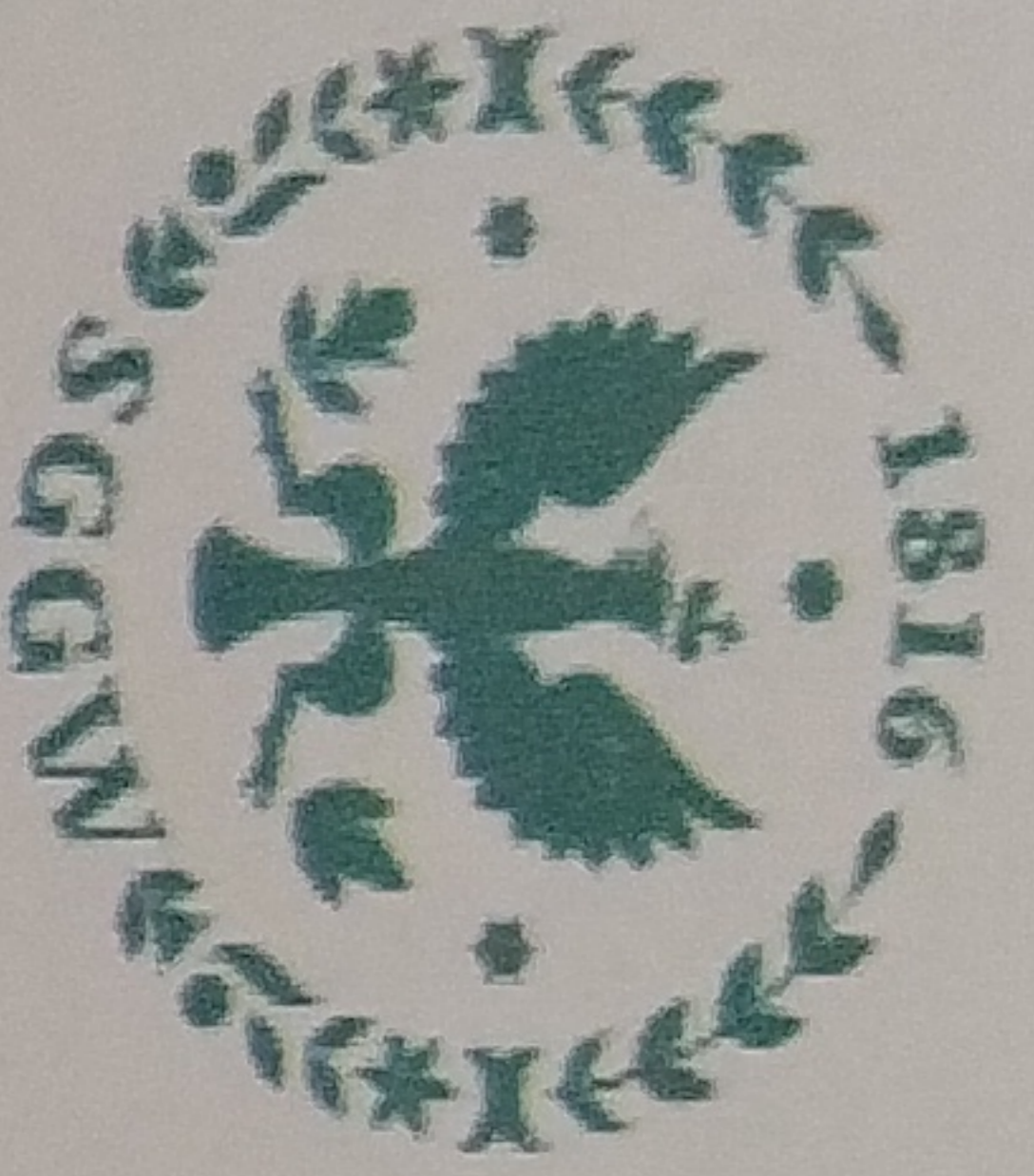

Nr No.	Imię i nazwisko Name and surname	Instytucja Institution	Podpis Signature	Kontakt (mail) Contact
13.	ADAM KIRIOR	MIM STUPSK	[Signature]	A.Kirior@um.stupsk.pl
14.	MARVIN JENIAK	PHIDS	[Signature]	marvin.jeniak@onet.pl
15.	MARCIN MILER	Państwowy Instytut Statystyczny	[Signature]	m.miler@powsinstat.gov.pl
16.	KAROLINA MIŁO	Uniwersytet Pomorski	[Signature]	karolina.milo@up.edu.pl
17.	ESMERALDA AHMED	Port Wodociąg Stupsk	[Signature]	esmeralda@powsinstat.gov.pl
18.				
19.				
20.				
21.				
22.				
23.				
24.				
25.				
26.				
27.				
28.				

Photo's from 2nd Regional stakeholder meeting in Poland





WP1: Ustalanie stężeń referencyjnych biogenów dla wód śródlądowych w celu ochrony bioty - jaką rolę odgrywa w tym klimat?

Anne Lyche Solheim, Jan Erik Thrane, Areti Balkoni (NIVA), Kirstine Thiemer (NIVA & AU), Brian Kronvang (AU), Jens Fölster (SLU), Jukka Aroviita (SYKE), Ainis Lagzdins (LV), Ignacy Kardel (PL)

Prezentacja na drugie warsztaty dla interesariuszy Nord-Balt ECOSAFE jesienią 2024 r.

Project: 101060020 — NORDBALT-ECOSAFE —
HORIZON-CL6-2021-ZEROPOLLUTION-01



Uzasadnienie podjęcia tematu

- Ramowa Dyrektywa Wodna UE (RDW) zobowiązuje kraje do ustalenia docelowych stężeń biogenów, które będą wspierać osiągnięcie dobrego stanu ekologicznego dla wrażliwych na biogeny biologicznych elementów jakości (BQE). Ogromne zróżnicowanie granic GMO między krajami dla porównywalnych typów:

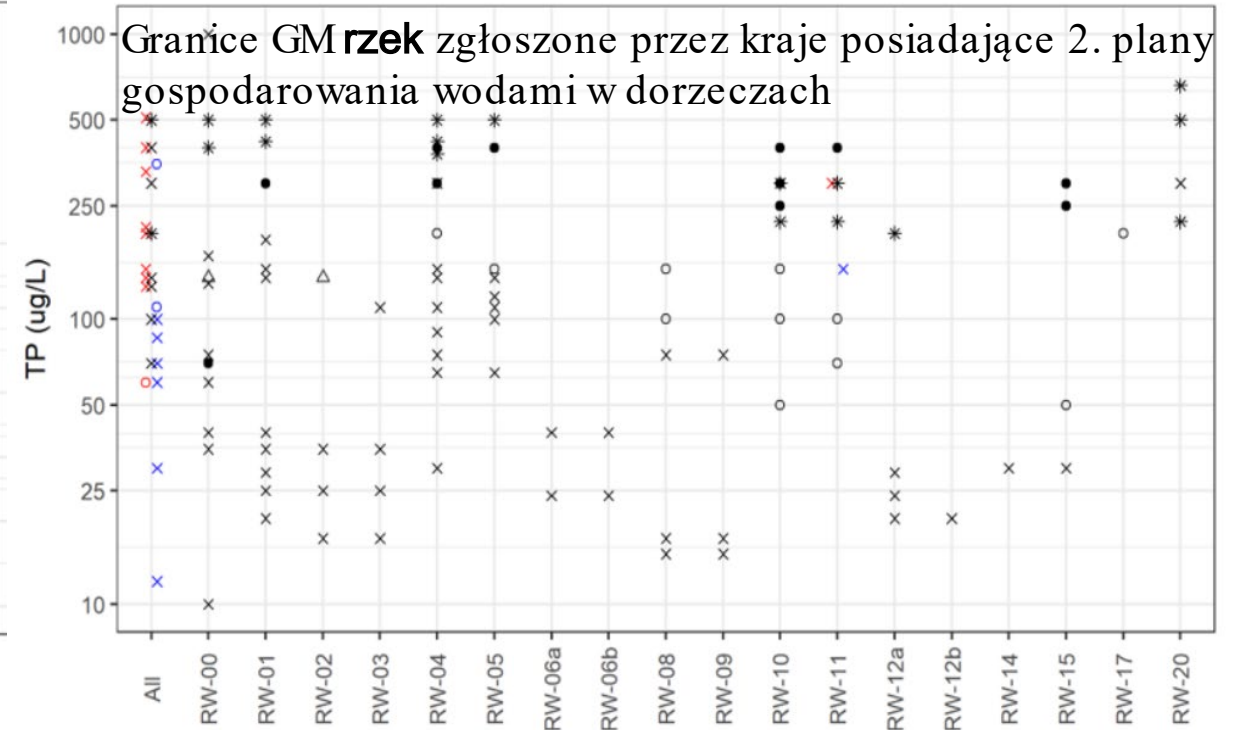
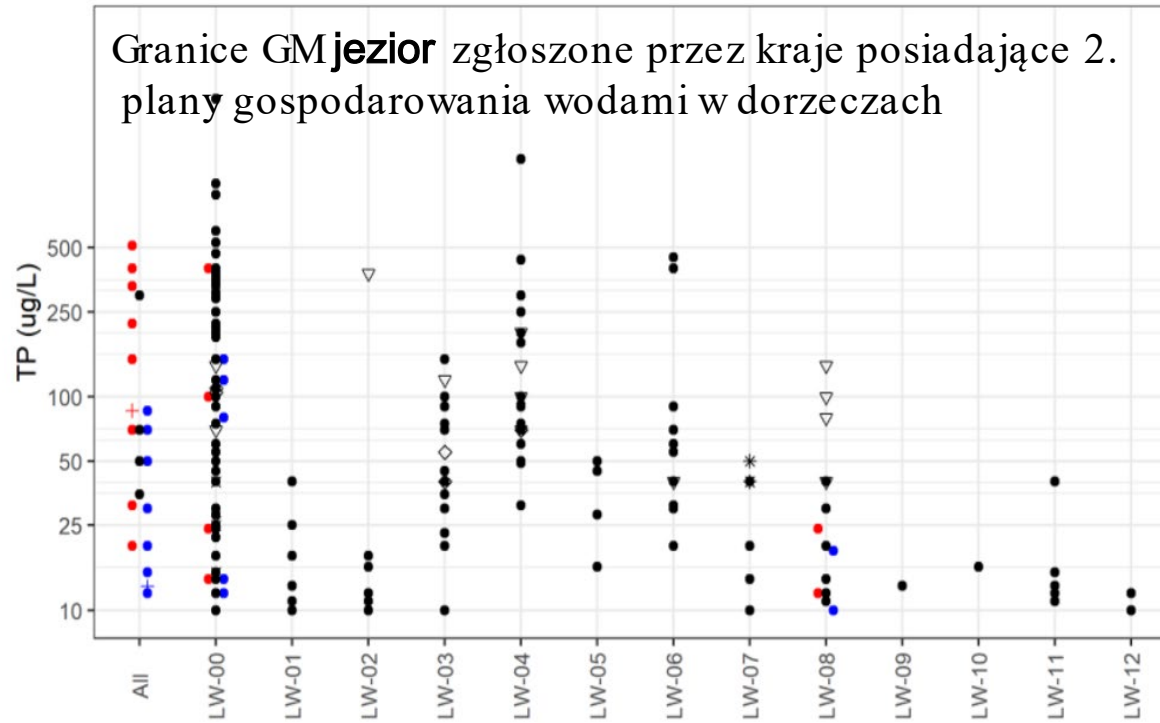

Czy wszystkie te wartości docelowe dla fosforu całkowitego (TP) wspierają dobry stan ekologiczny dla BQE?

Zestawy danych dla wspólnych typów w krajach partnerskich Nord-Balt Ecosafe:

Fitoplankton jeziorny

Fitobentos rzeczny

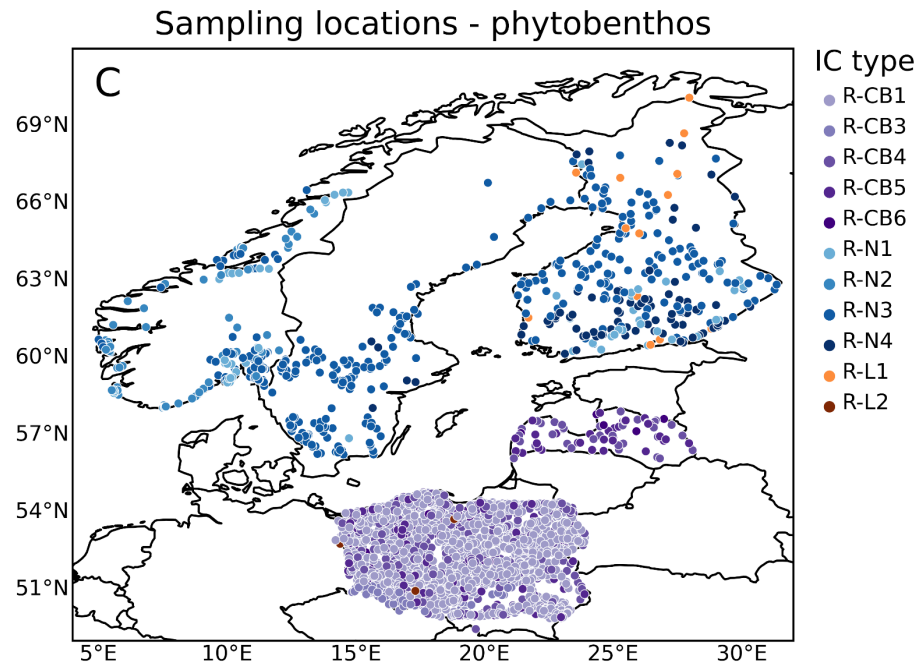
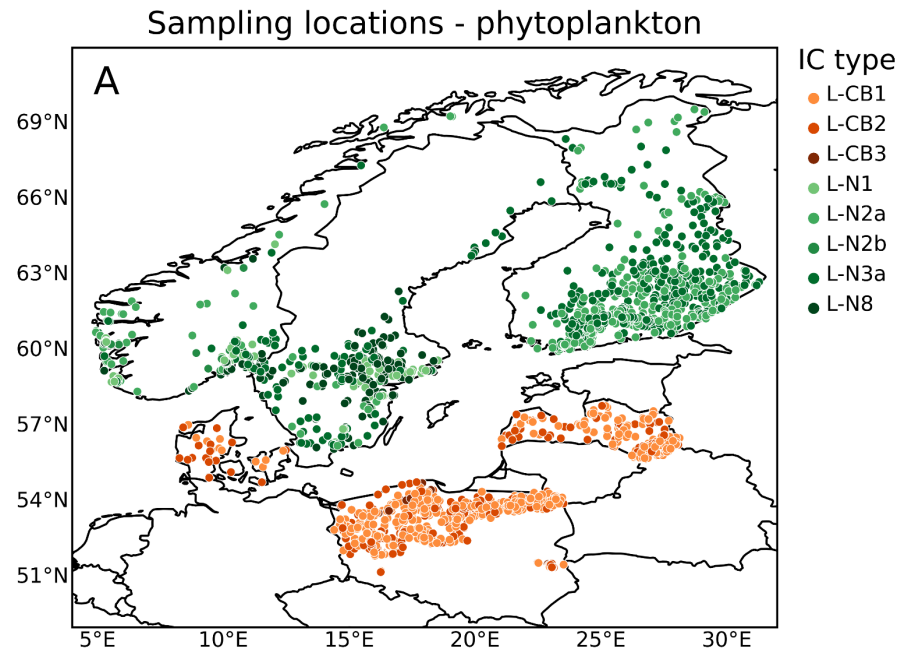

+ średnie roczne stężenia fosforu całkowitego i azotu całkowitego dla wszystkich jednolitych części wód z danymi biologicznymi przeliczonymi na znormalizowane wartości wskaźnika jakości ekologicznej (nEQR).

Wartości EQR są potrzebne do porównywania danych między zmiennymi i krajami.

Wartości EQR wskazują stan biologicznego elementu jakości, np. fitobentosu w rzekach i fitoplanktonu w jeziorach, i są oparte na odchyleniach od zbiorowisk referencyjnych w zharmonizowanej skali od 1 (niezakłócony) do 0 (całkowicie pogorszony).

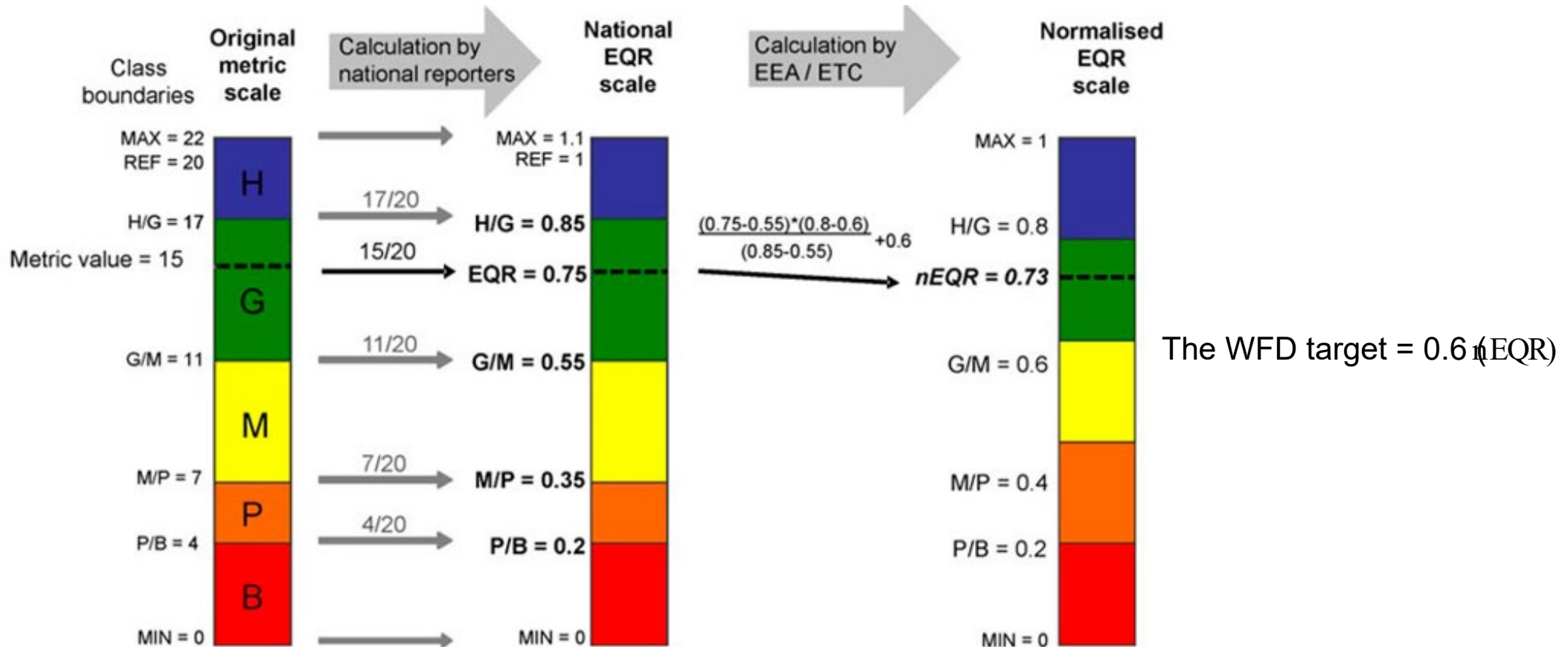

Podejście stosowane do ustalania granic biogenów w celu wspierania dobrego stanu biologicznych elementów jakości (BQE), na przykład fitobentosu

IC type R-N3 "Small/medium, lowland, organic, low alkalinity"

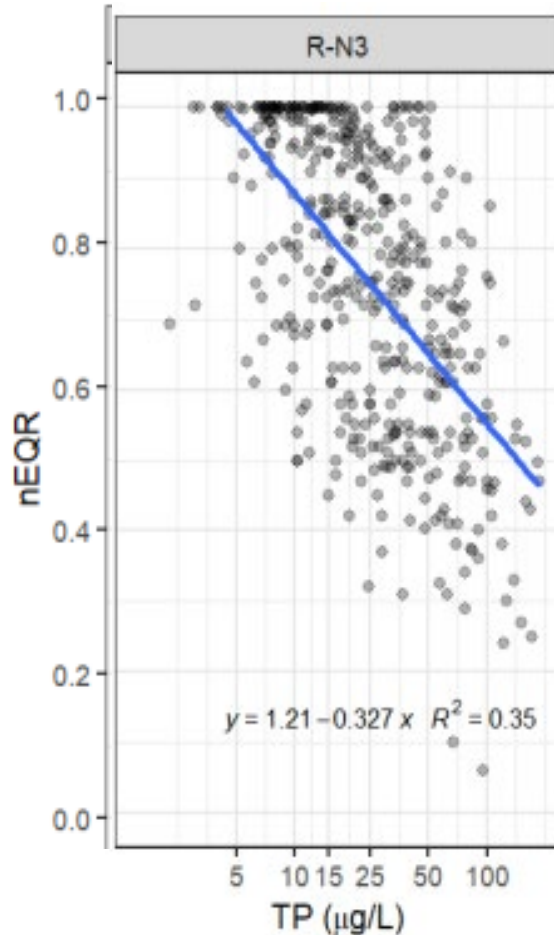

- Dwumianowa regresja logistyczna (BLR), przekształcająca regresję liniową wartości nEQR dla BQE w prawdopodobieństwo dobrego stanu ($EQR > 0,6$) lub niezadawalającego stanu ($EQR < 0,6$)
- Solidna metoda umożliwiająca równoważenie rozbieżności między fosforem całkowitym (TP) a wartościami EQR
- Zalecana przez grupę WFD CIS ECOSTAT, uwzględniona w wytycznych CIS-Best Practice v. 2, 2024 r.

TP vs phytobenthos nEQR					
Nordic river type	Country datasets	Total # WBs	Metric	GM boundary (µg/L)	probability of good
R-N3: Lowland, siliceous, humic rivers	FI=175, NO=116, SE=151	442	Kappa	38 [33-46]	0,66
			Omis =Comm	31 [26-36]	0,73
			FNR=FPR	44 [38-53]	0,61

Wyniki BLR i porównanie z aktualnymi granicami GM: Fosfor całkowity w jeziorach w regionie śródkowo-bałtyckim

Total Phosphorus ($\mu\text{g L}^{-1}$) Central-Baltic region		Lowland types	
CB-GIG type	Type description	L-CB1	L-CB2
		high alkalinity, stratified, non-humic	high alkalinity, non-stratified (very shallow), non-humic
BQE used for modelling		Phytoplankton	Phytoplankton
	mean	44	55
	conf.limits	39-49	47-63
modelled GM boundaries	r2	0.29	0.44
	prob good	0.58	0.48
	N (# WBs)	678	230
current GM boundaries	DK*	31	53
	LV	50	60
	PL	40-60	80

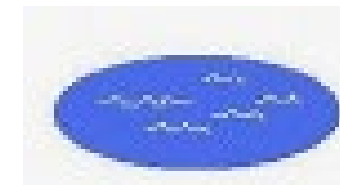

* The officially reported DK boundary is 82 $\mu\text{g/L}$ for L-CB2, which is too high

Current boundaries in yellow need validation with ECOSTAT toolkit (Shiny App)

Wyniki BLR i porównanie z obecnymi granicami GM: Fosfor całkowity w rzekach w regionie środkowo-bałtyckim

Total Phosphorus ($\mu\text{g L}^{-1}$)		Lowland river types	
Central-Baltic region		Lowland river types	
CB-GIG type		R-CB3 (R-CB2) ²	R-CB5
Type description		low alkalinity (< 0.4 mmol/L), small (10-100 km ²), siliceous	high alkalinity (>0.4 mmol/L), large (1000-10000 km ²)
BQE used for modelling		Benthic inverts	Phytobenthos
modelled GM boundaries	mean	119	106
	conf.limits	16-362	68-138
	r ²	0.31	0.14
	prob good	0.73	0.72
	N (# WBs)	61	164
current GM boundaries	DK	na	na
	LV		65-90
	PL	130-350	170-330



Very wide confidence limits and low r²

Obecne granice zaznaczone na żółto wymagają walidacji za pomocą zestawu narzędzi ECOSTAT (aplikacja Shiny).

¹ R-CB2 is lowland, but data are from R-CB3 mid-altitude.

³ R-CB5 is lowland, but the PL boundary is for a comparable mid-altitude type, no boundary has been set for the lowland type

Wyniki BLR i porównanie z obecnymi granicami GM: Azot całkowity w rzekach w regionie środkowo-bałtyckim



Total Nitrogen ($\mu\text{g L}^{-1}$)		Lowland river types	
Central-Baltic region		Lowland river types	
CB-GIG type	Type description	R-CB3 (R-CB2) ¹ low alkalinity (< 0.4 mmol/L), small (10-100 km ²), siliceous	R-CB5 high alkalinity (>0.4 mmol/L), large (1000-10000 km ²)
BQE used for modelling		Benthic inverts	Phytobenthos
modelled GM boundaries	mean	na	2299
	conf.limits	na	1588-3348
	r ²	na	0.13
	prob good	na	0.68
	N (# WBs)	na	160
current GM boundaries	DK	na	na
	LV		2300-3000
	PL	1800-3000	2000-3300

Bardzo szerokie granice ufności i niskie r²

¹ R-CB2 is lowland, but data are from R-CB3 mid-altitude.

³ R-CB5 is lowland, but the PL boundary is for a comparable mid-altitude type, no boundary has been set for the lowland type

Główne przesłania i refleksje

- -Oszacowane granice GM były w większości zgodne z obecnymi granicami w krajach ECOSAFE Nord-Balt, z wyjątkiem granic FI dla niektórych typów jezior i rzek oraz granic PL dla rzek typu R-C5.
- **-Granice środkowo-bałtyckie są wyższe niż nordyckie.**
 - Fauna i flora słodkowodna nie reaguje tak silnie na biogeny w krajach CB, jak w krajach skandynawskich, gdzie zwykle stwierdza się silny wpływ na fitobentos w zakresie 10-100 $\mu\text{g TP L}^{-1}$
 - **dlaczego?**
 - Wyższa zasadowość i naturalnie cieplejszy klimat?
 - Różne typy?
 - Bardziej wyraźne dodatkowe presje, np. zamulenie powodujące ograniczenie światła?
 - pestycydy,
 - metale ciężkie
 - czynniki te mogą zapobiegać lub zmniejszać reakcję BQE na biogeny
 - Czy należy stosować wiele presji, aby uzasadnić łagodniejsze granice?

Wpływ zmian klimatu na stan ekologiczny fauny i flory słodkowodnej

Kluczowe pytania, na które należy odpowiedzieć:

- Czy BQE stają się bardziej lub mniej wrażliwe na biogeny z powodu zmian klimatu?
 - **Bardziej wrażliwe** z powodu cieplejszych wód i niższych poziomów tlenu?
 - **Mniej wrażliwe** z powodu zwiększonego zmętnienia lub spłukiwania?
- Czy docelowe wartości biogenów należy dostosować ze względu na wpływ klimatu?
- Czy konieczne są dodatkowe środki redukcji biogenów w celu złagodzenia potencjalnie negatywnego wpływu zmian klimatu na stężenia biogenów i na odporność (tolerancję) fauny i flory słodkowodnej na zanieczyszczenie biogenami?

Ekstrakcja zmiennych klimatycznych dla lokalizacji Nord-Balt

Dane klimatyczne zostały pobrane z europejskiego zbioru danych obserwacyjnych Copernicus (ES) dla każdej jednolitej części wód z tego samego okresu, co dane dotyczące EQR i biogenów

Annual mean air temperature

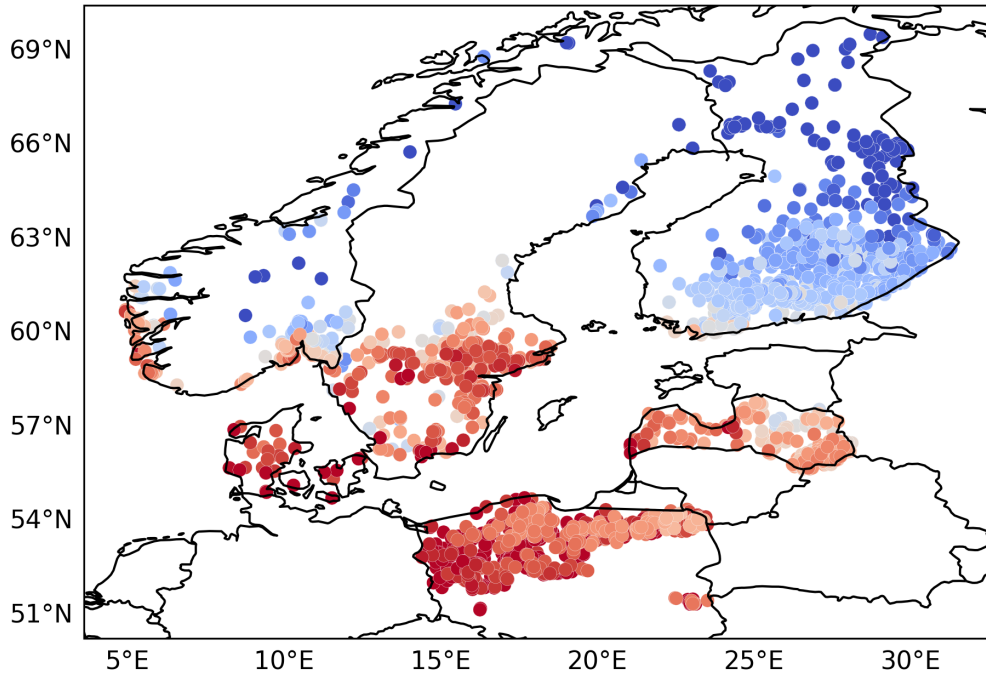

Daily mean precipitation

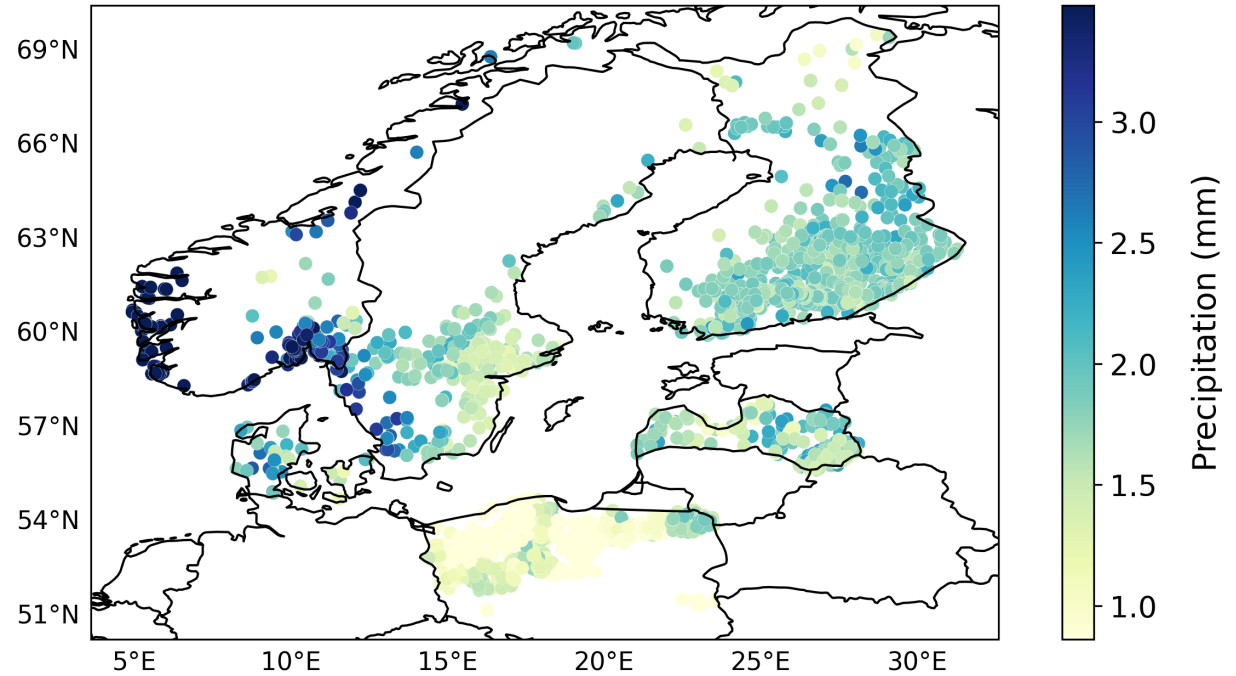

Wpływ klimatu na wartości EQR: Przykład skandynawskich jezior humusowych

- Wstępne wyniki oparte na uogólnionych liniowych modelach mieszanych (GLMM) wskazują, że:
 - Wzrost TP, średnie dzienne opady i średnia roczna temperatura mogą obniżyć stan ekologiczny fitoplanktonu w skandynawskich jeziorach humusowych.
 - Wpływ klimatu jest mniej wyraźny niż wpływ TP.

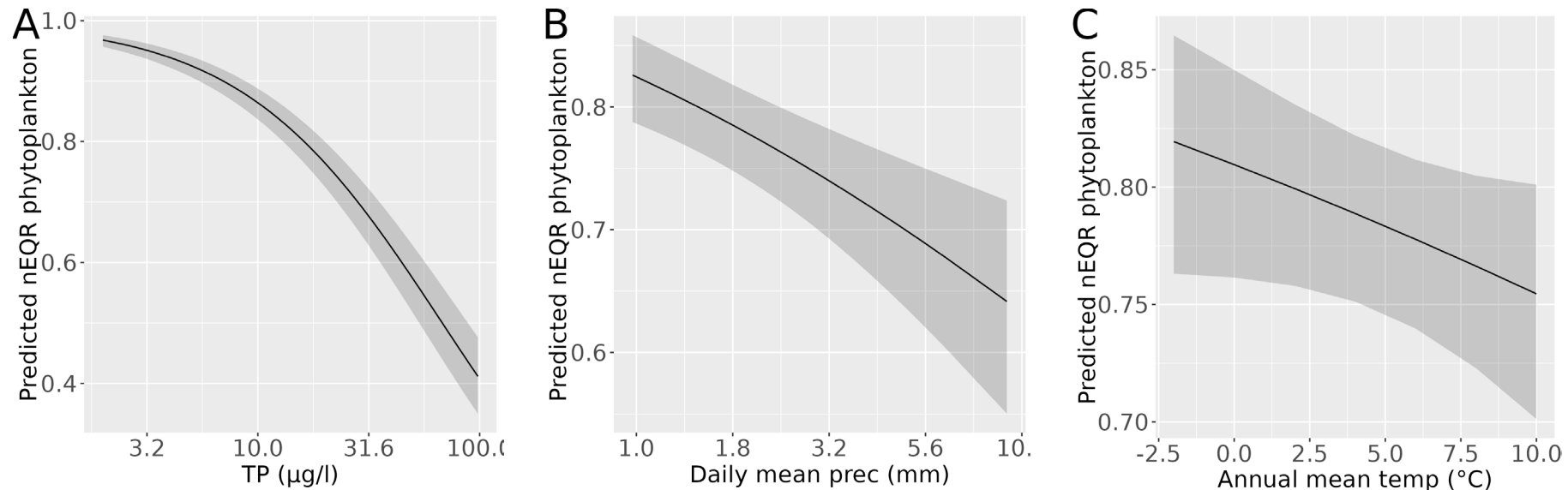

Pozostały prace modelowe: Modelowanie GAM w celu poszukiwania nieliniowego i interaktywnego wpływu TP i zmiennych klimatycznych na wartości EQR.

Pozostałe prace w WP1:

- Praca z lepszymi modelami w celu oceny połączonego wpływu biogenów, parametrów klimatycznych
- Praca z lepszymi modelami w celu oceny połączonego wpływu biogenów i parametrów klimatycznych. Krótki opis polityki może zostać opracowany wiosną 2025 r. Krótki opis polityki może zostać opracowany wiosną 2025 r.

Acknowledgments :

- Geoff Phillips (JRC consultant) for BLR training of NIVA staff
- EU project funding:
 - Project: 101060020 —NORDBALT-ECOSAFE —HORIZON-CL6-2021-ZEROPOLLUTION-01

Budowa narzędzia do symulacji efektywności działań ochronnych w zlewni Słupi (model SWAT+)

Mikołaj Piniewski

Katedra Hydrologii, Meteorologii i Gospodarki Wodnej SGGW



Schemat ogólny procesu modelowania w projekcie

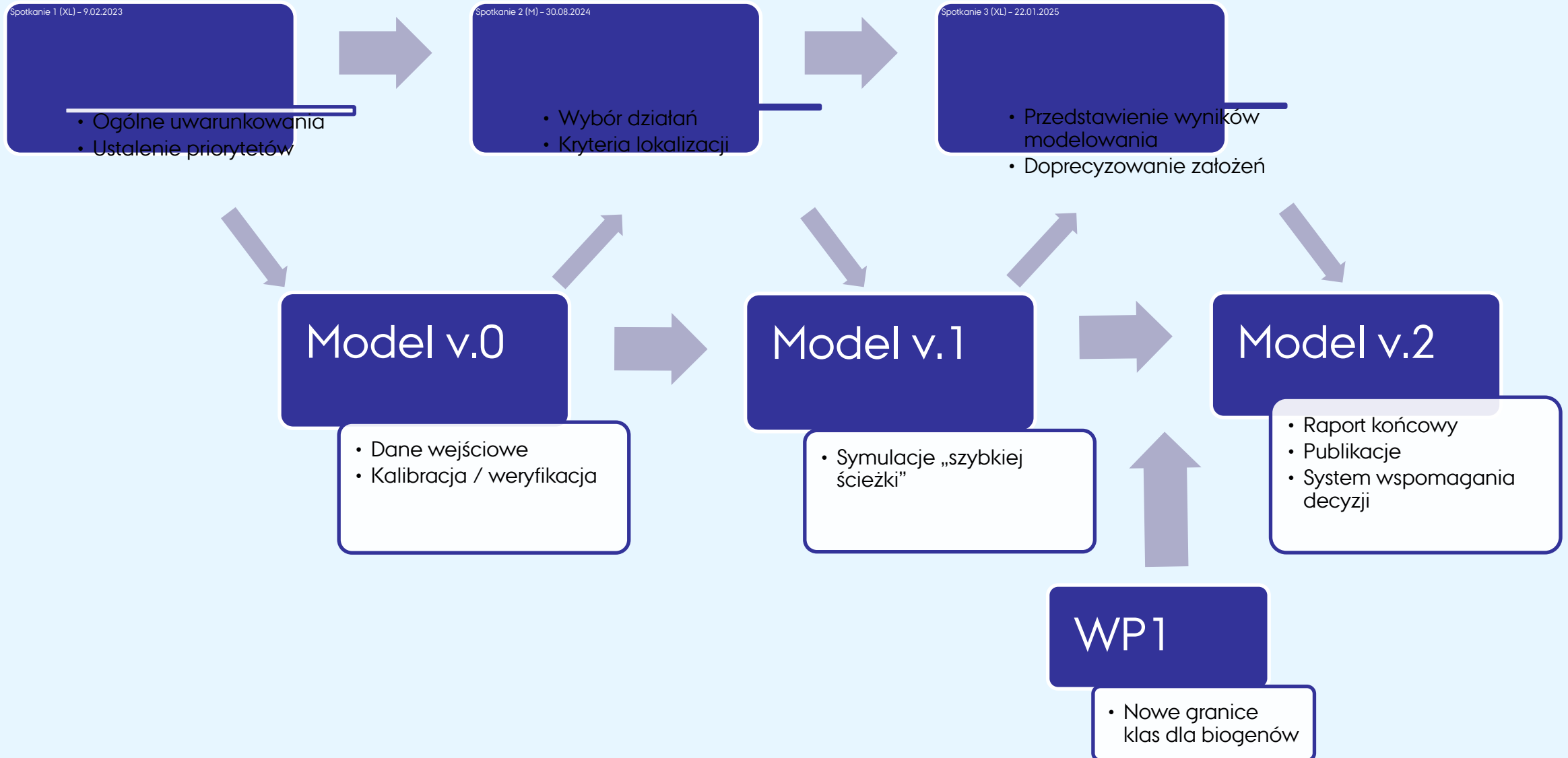

Modelowanie - co to znaczy?

Narzędzie - model symulacyjny (SWAT+)

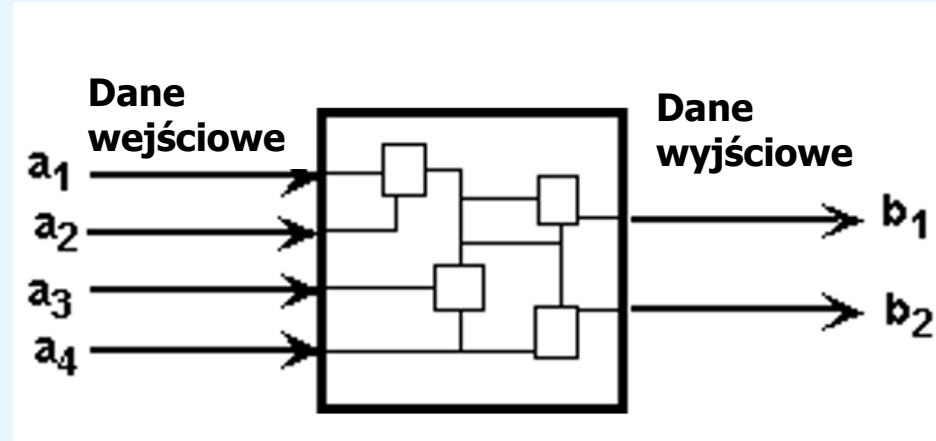

Przedmiot badań: obieg wody i materii w zlewni

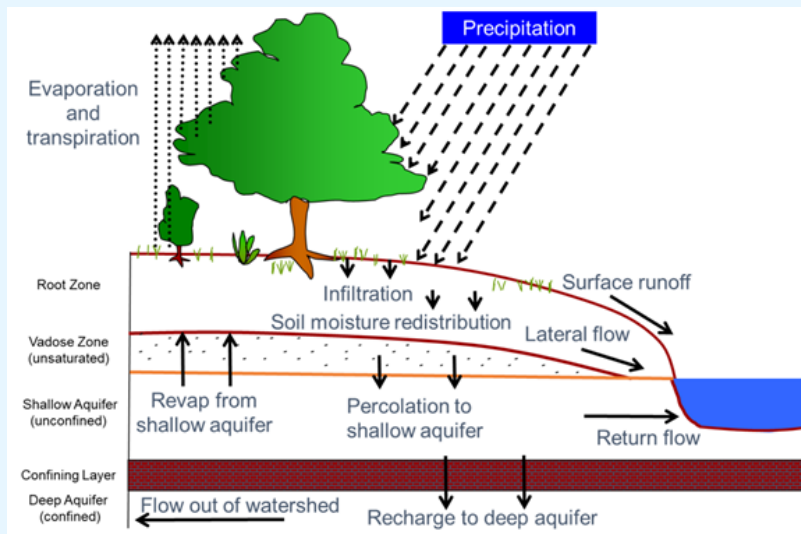

+ działania człowieka



Model SWAT+ - procesy

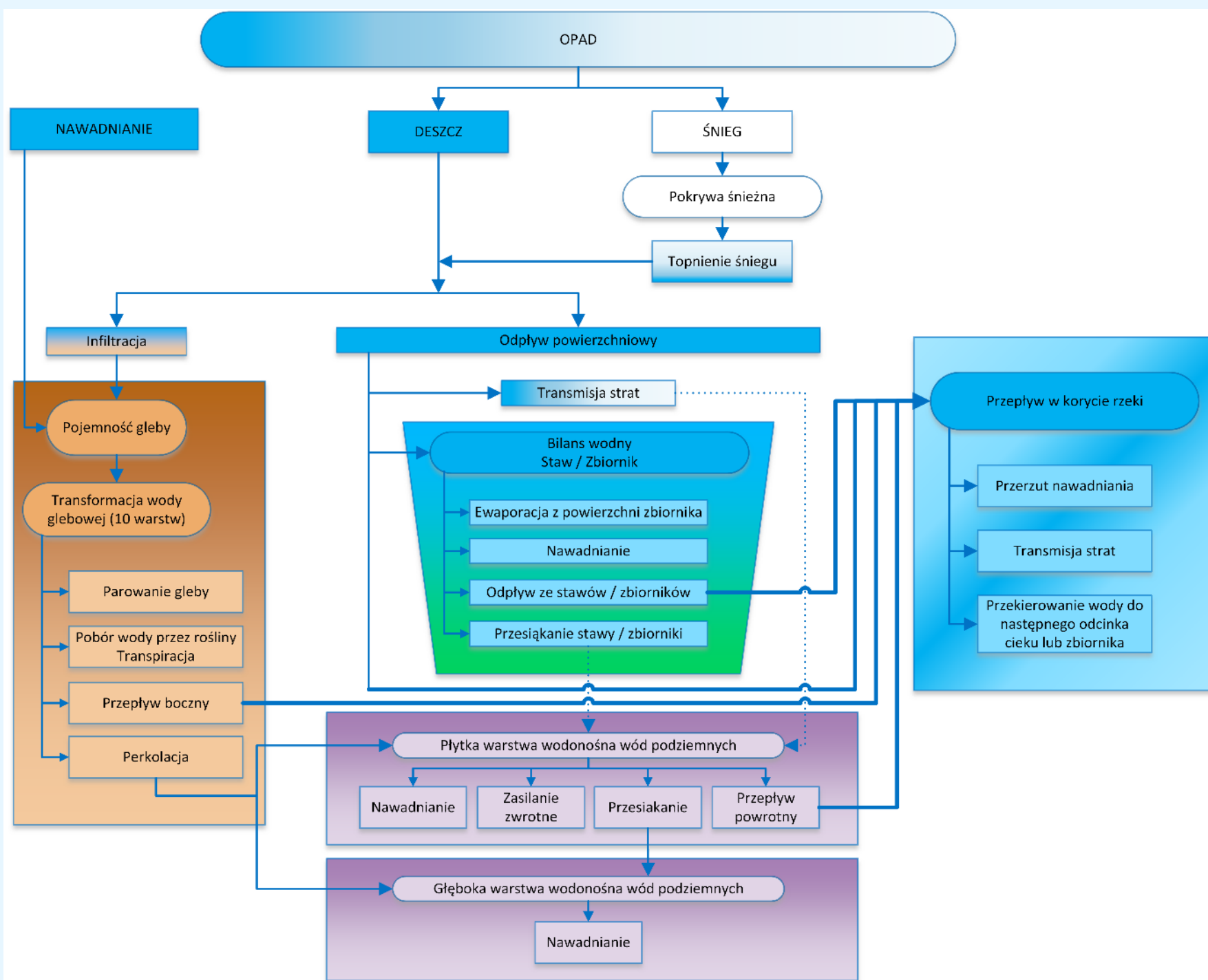
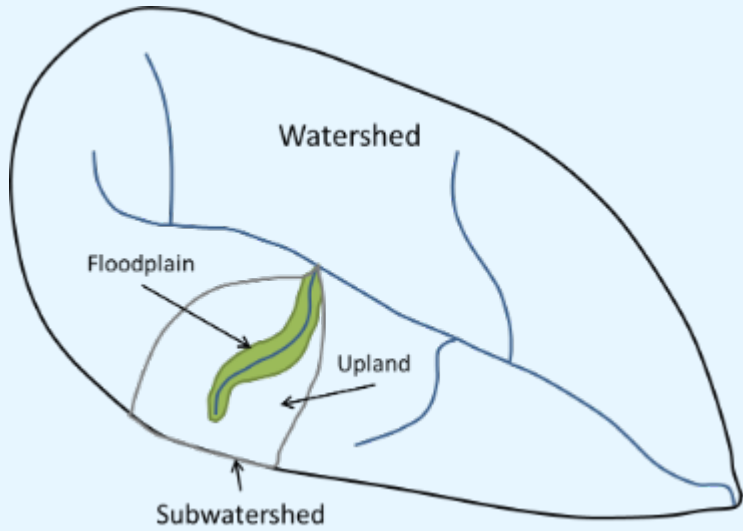

Typ danych	Atrybuty	Źródło	Rozdzielczość / skala
Numeryczny model terenu	Wysokość n.p.m.	GUGIK	10 m
Sieć hydrograficzna	Cieki, jeziora	BDOT10	1 057 cieków i 501 jezior
Mapa pokrycia terenu	Klasy pokrycia terenu	BDOT10	~ 45 000 obiektów
Struktura upraw	Coroczne mapy upraw 2020-2023	ARiMR	~ 26 000 pól
Mapa glebowa	Gatunki gleb	IUNG-PIB	1:100 000
Zrzuty ścieków	Lokalizacja i wielkość zrzutu/poboru	Ankieta oczyszczalni	Kilkanaście obiektów
Systemy drenarskie	Lokalizacja / zasięg	GeoMelio (WP)	1: 5 000
Dane meteorologiczne	Opad, temperatura, wilgotność, radiacja, prędkość wiatru	IMGW-PIB	Dobowa
Depozycja atmosferyczna	Sucha i mokra depozycja azotu	EMEP	Roczna
Zabiegi agrotechniczne	M.in. orka, siew, nawożenie, zbiór	PODR	10 „klas” roślin uprawnych
Dane obserwacyjne - ilość	Przeptywy (Charnowo)	IMGW-PIB	Dobowe
Dane obserwacyjne - jakość	Stężenia biogenów (N, P) w ciekach (Charnowo)	IMGW-PIB	~ raz w miesiącu
Dane obserwacyjne – plony	Plony głównych roślin uprawnych	PODR (eksperckie)	12 roślin uprawnych

Mapy wejściowe

a) Monitoring / Zrzuty ścieków

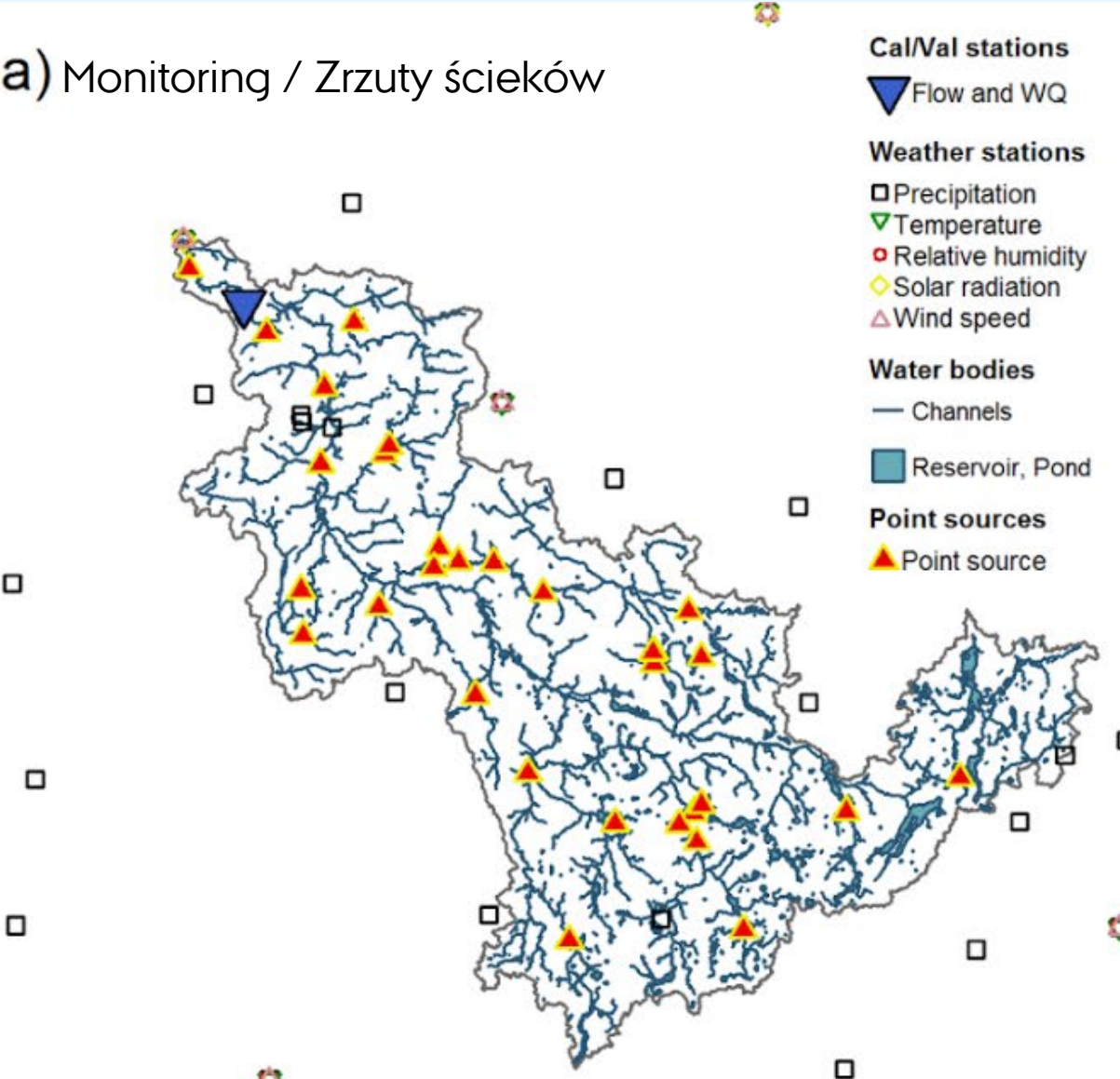

b) Numeryczny Model Terenu

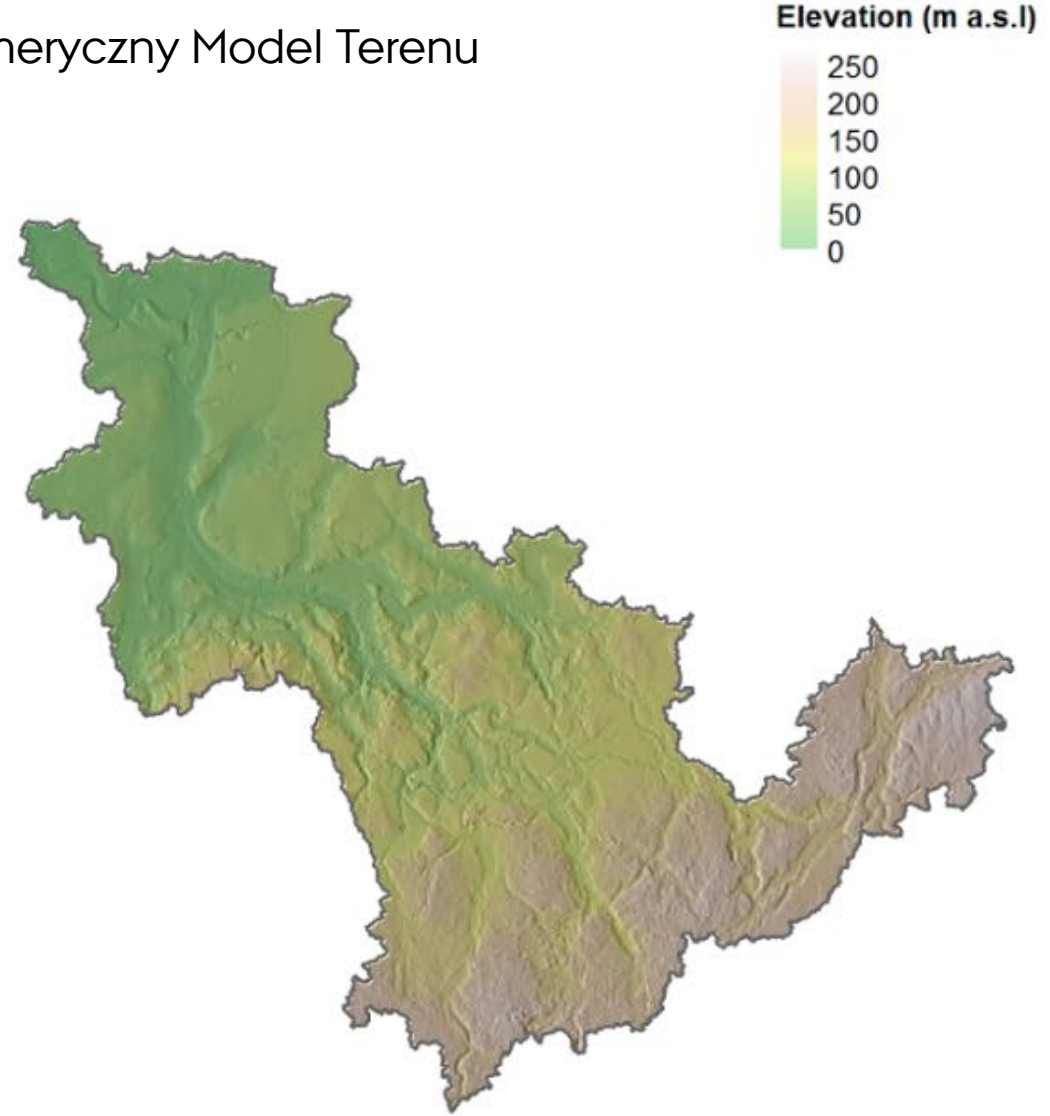

Mapy wejściowe

c) Użytkowanie terenu

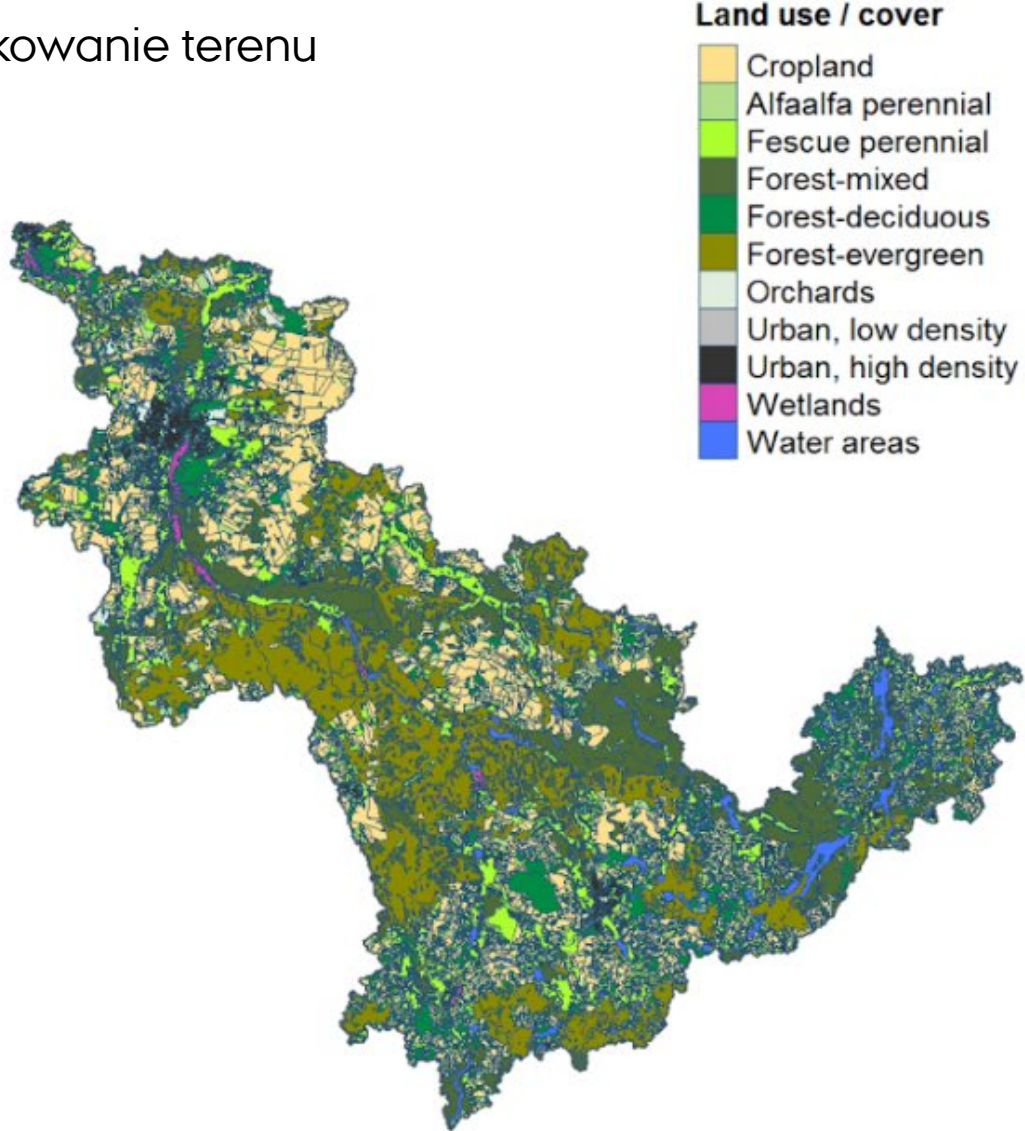

d) Gleby

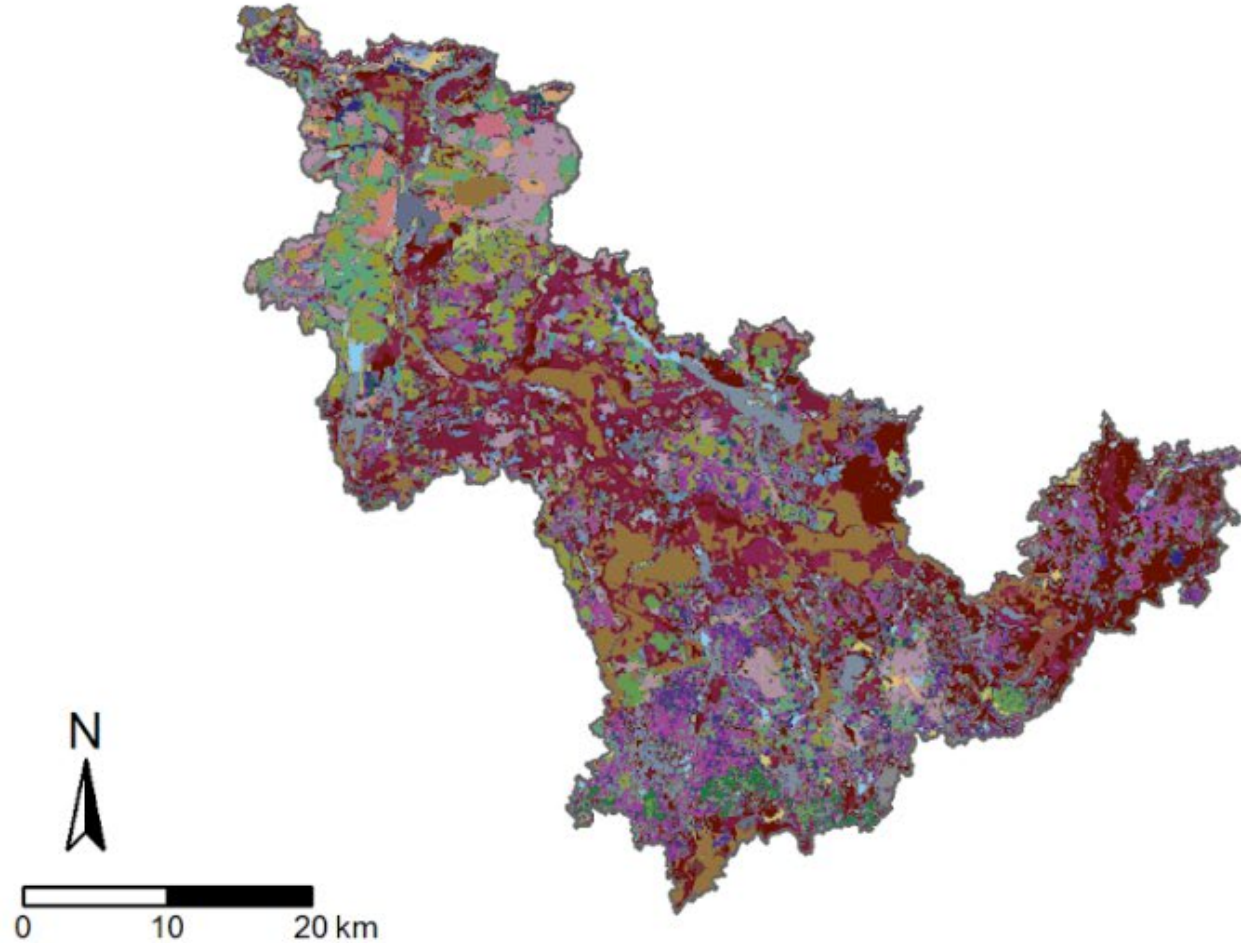



AA



Jednostki HRU

RDBALT
SAFE

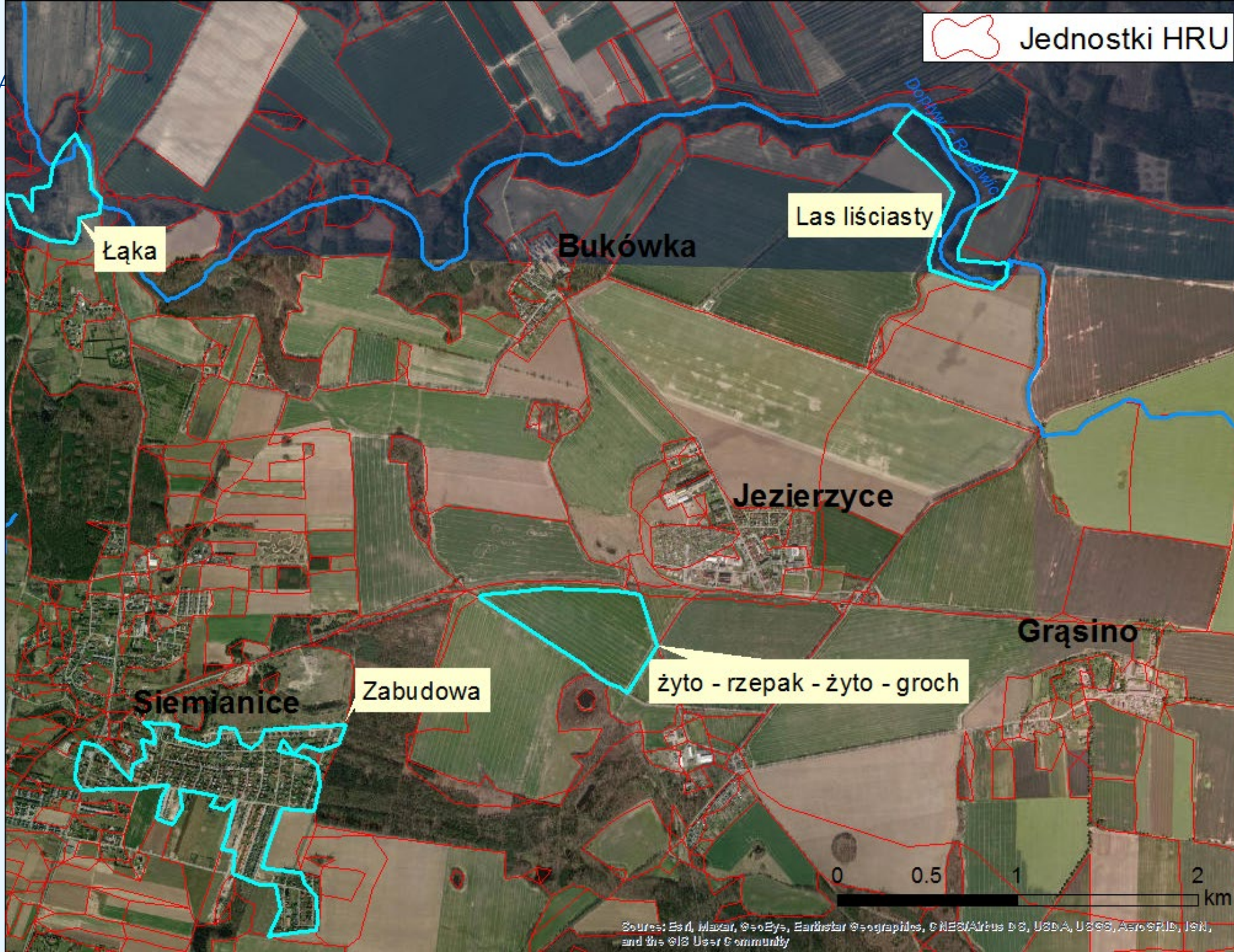

Sekwencje upraw w modelu

2015

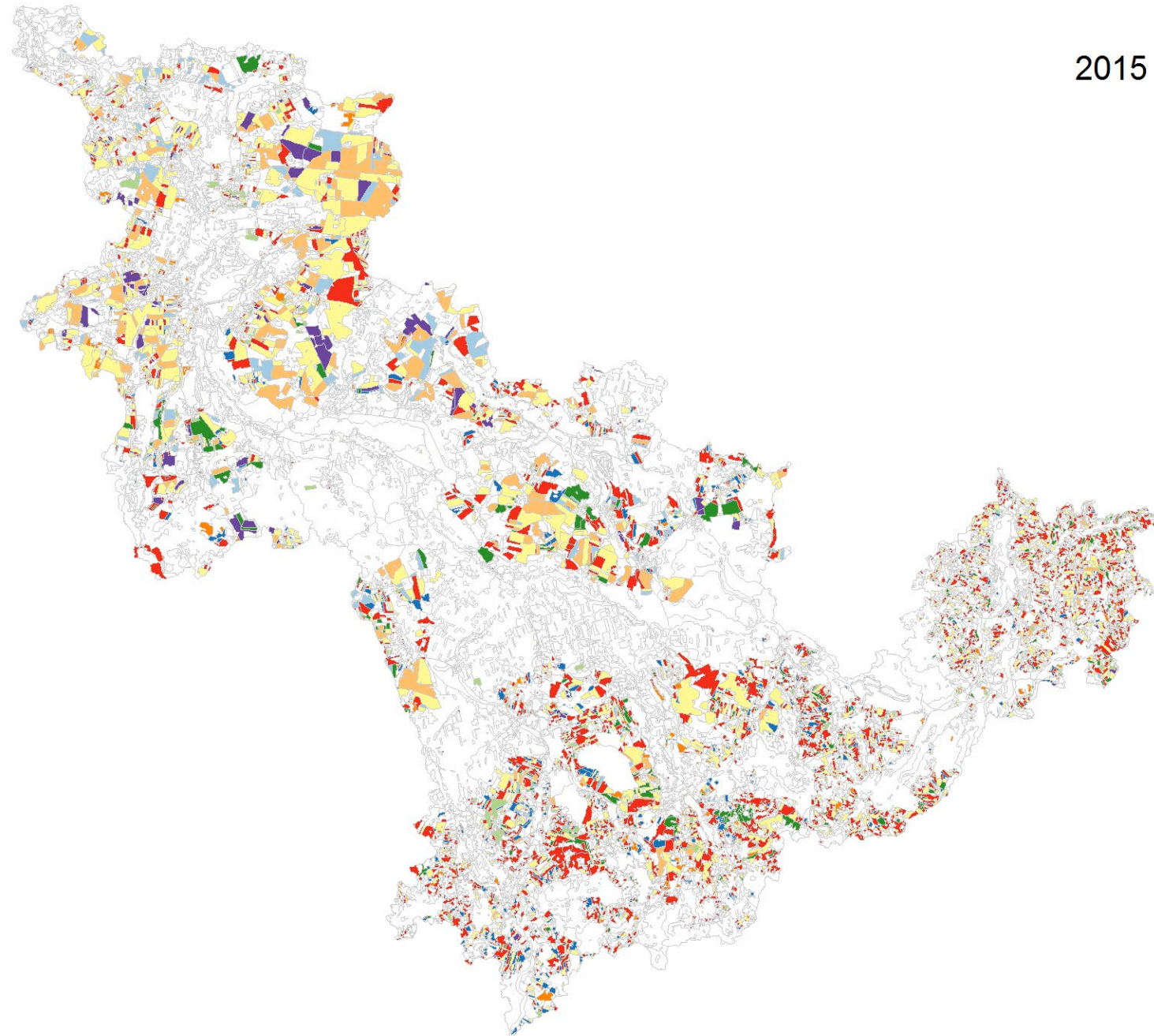

Roslina	
light blue	groch
dark blue	gryka
light green	inne
dark green	kukurydza
pink	lubin
red	mieszanka jara
orange	rzepak
yellow	ugory
purple	uzytki zielone
dark purple	ziemniak
yellow	zyto

Struktura użytkowania terenu

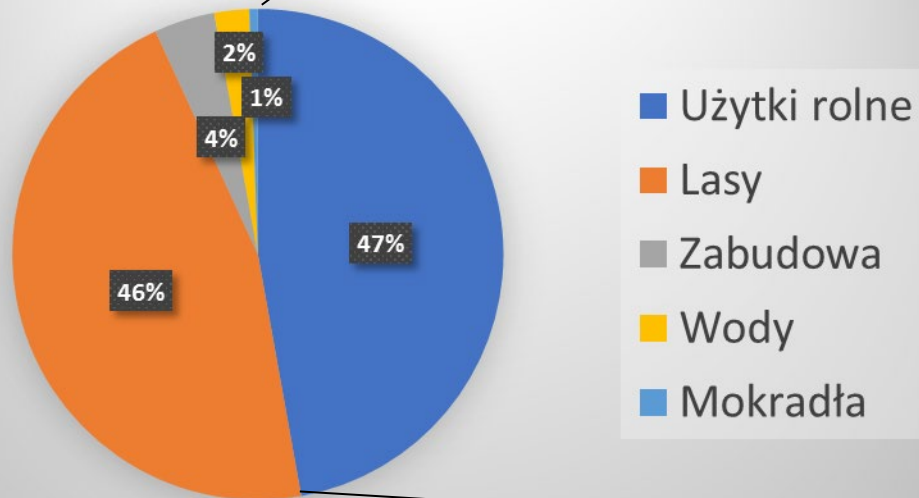

Struktura upraw (2023)

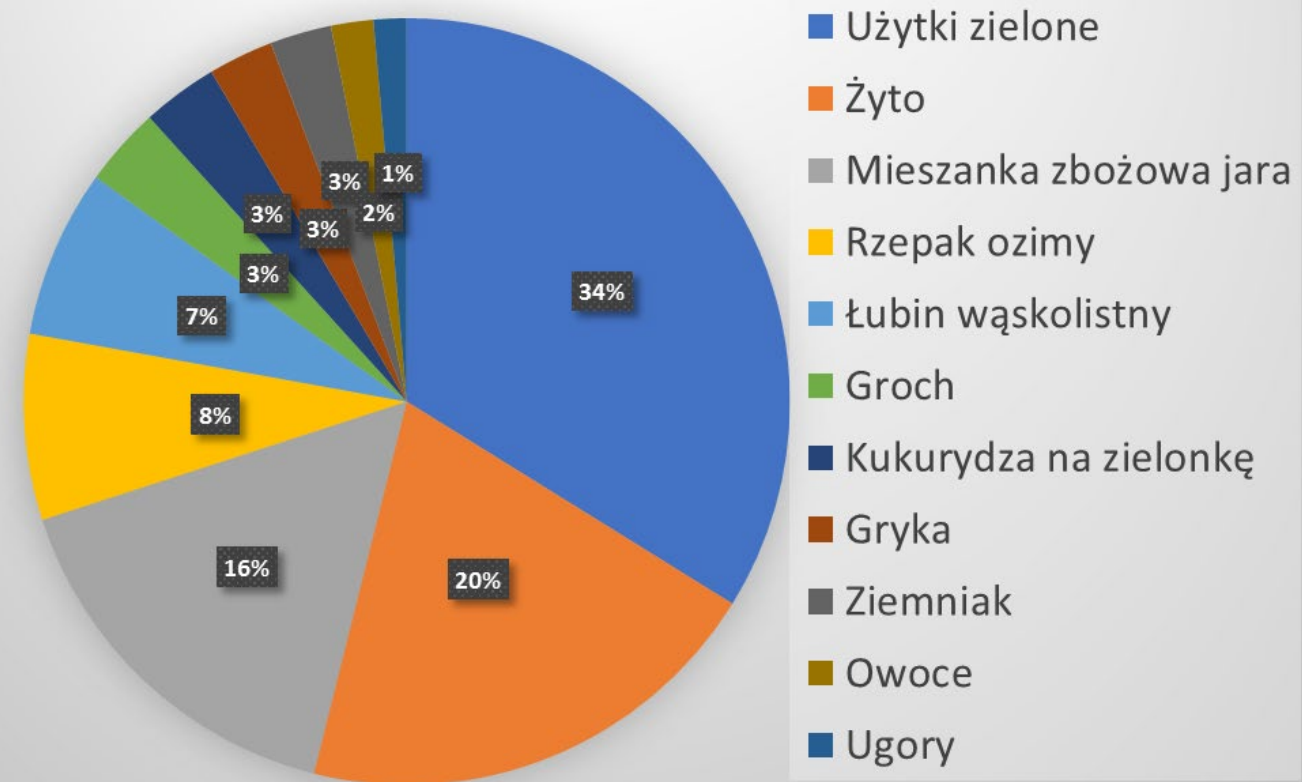

Źródło: ARiMR (dane zgeneralizowa

**Kalendarz praktyk rolniczych dla modelu SWAT zlewni Słupi****Roślina: rzepak ozimy**

Uwaga - proszę dodawać kolejne operacje w sposób chronologiczny licząc od pierwszej operacji która następuje po żniwach poprzedniej rośliny

Zakresy dat (min i max) poszczególnych operacji mają dotyczyć typowych/przeciętnych warunków dla zlewni

Dawki nawożenia również powinny odzwierciedlać warunki typowe/przeciętne dla zlewni

L.p.	Operacja	Miesiąc_min	Dzień_min	Miesiąc_max	Dzień_max	Dawka nawożenia [kg/ha]	Uwagi
1	Orka średnia	8	1	8	10		
2	Nawożenie-N	8	1	8	10	25	
3	Siew	8	15	8	25		
4	Nawożenie-N	3	10	3	20	100	
5	Nawożenie-P	4	1	4	10	70	
6	Żniwa	7					plon rzepaku 3,5-4,5 t/ha

Źródło: PODR

1247206	field_7337_drn_mgt_7328_1	188	0							
1247207						fert	3	5	0.000	elem_n broadcast 85
1247208						fert	4	9	0.000	elem_n broadcast 45
1247209						harv	7	11	0.000	canp grain 0
1247210						kill	7	11	0.000	canp null 0
1247211						till	9	25	0.000	fallplow null 0
1247212						fert	9	25	0.000	elem_n broadcast 25
1247213						fert	9	25	0.000	elem_p broadcast 25
1247214						plnt	9	25	0.000	wwht null 0
1247215						skip	0	0	0.000	null null 0
1247216						fert	3	26	0.000	elem_n broadcast 65
1247217						fert	5	16	0.000	elem_n broadcast 45
1247218						harv	8	1	0.000	wwht grain 0
1247219						kill	8	1	0.000	wwht null 0
1247220						till	8	12	0.000	landlevl null 0
1247221						fert	10	13	0.000	swine_fr broadcast 30000
1247222						till	10	13	0.000	fallplow null 0
1247223						skip	0	0	0.000	null null 0

Kalibracja plonów głównych roślin

Dane obserwowane

- › Plony (PODR – ocena ekspercka)

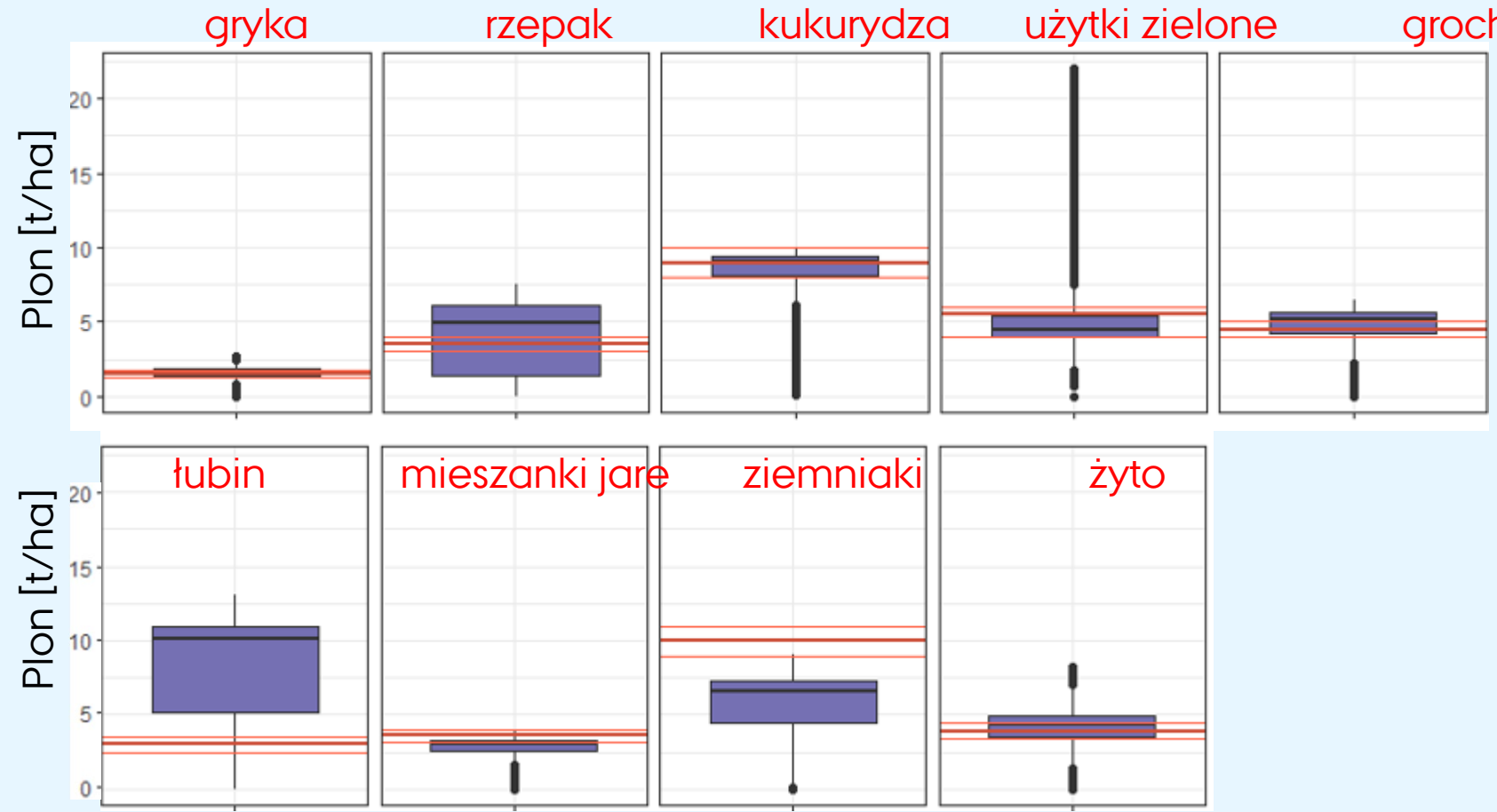

Weryfikacja modelu (Słupia - Charnowo)

Dane obserwowane:

- > Przepływy (IMGW)
- > Stężenia $\text{NO}_3\text{-N}$ (GIOŚ)
- > Ładunki - obliczenia własne

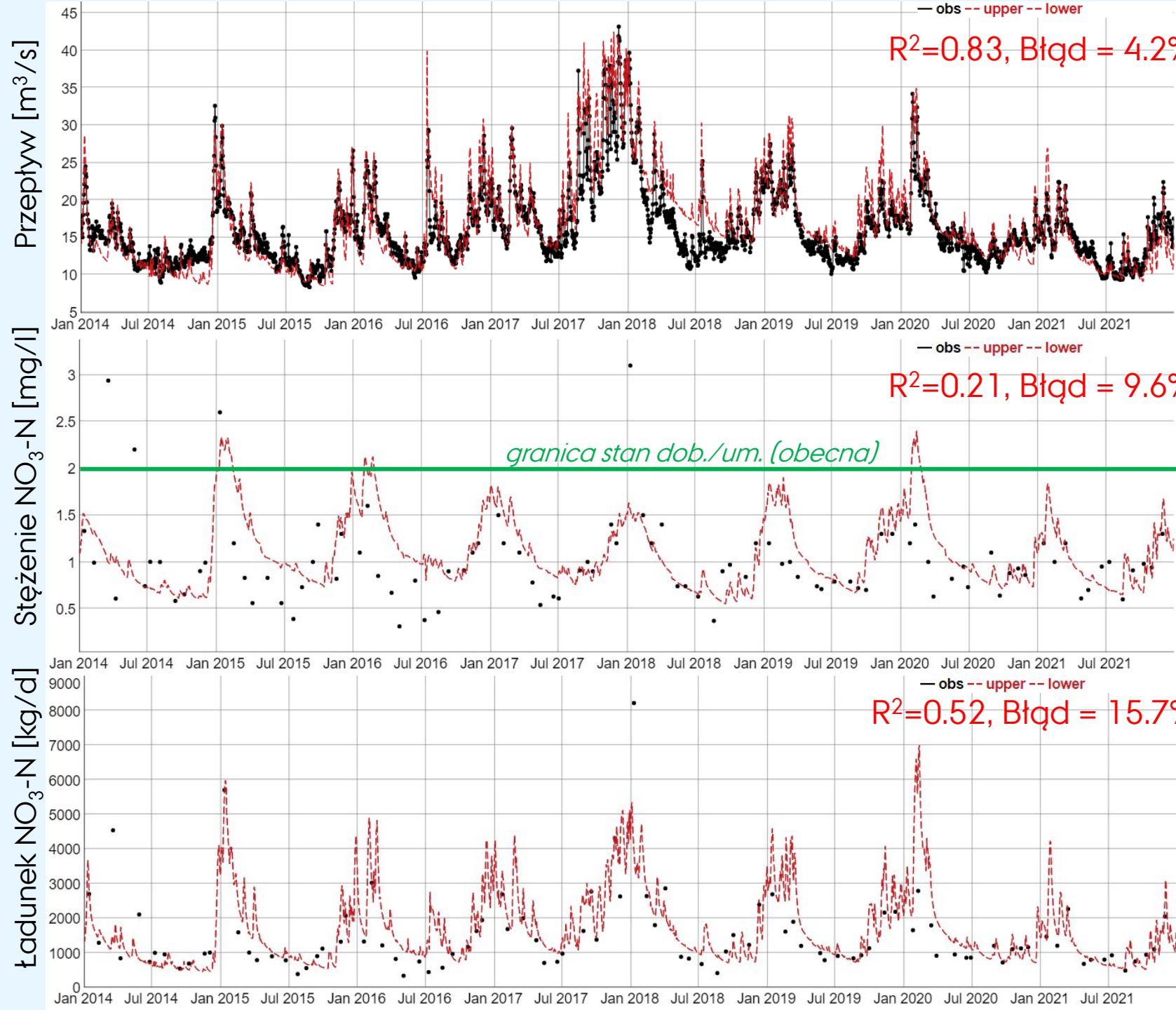

Weryfikacja modelu (Słupia - Charnowo)

Dane obserwowane:

- > Przepływy (IMGW)
- > Stężenia TN (GIOŚ)
- > Ładunki - obliczenia własne

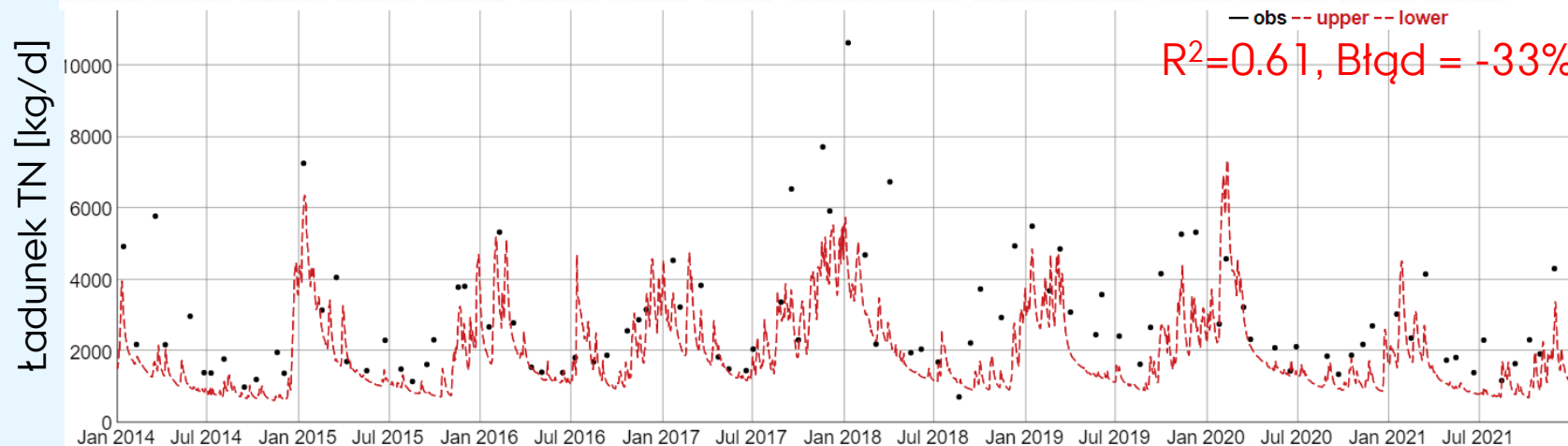
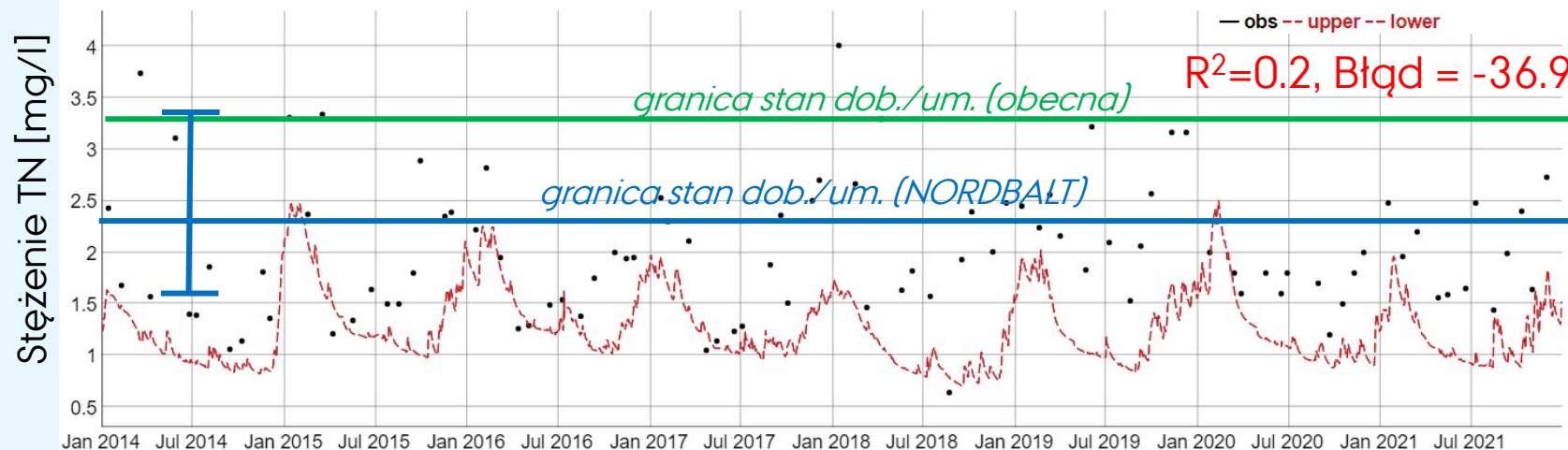
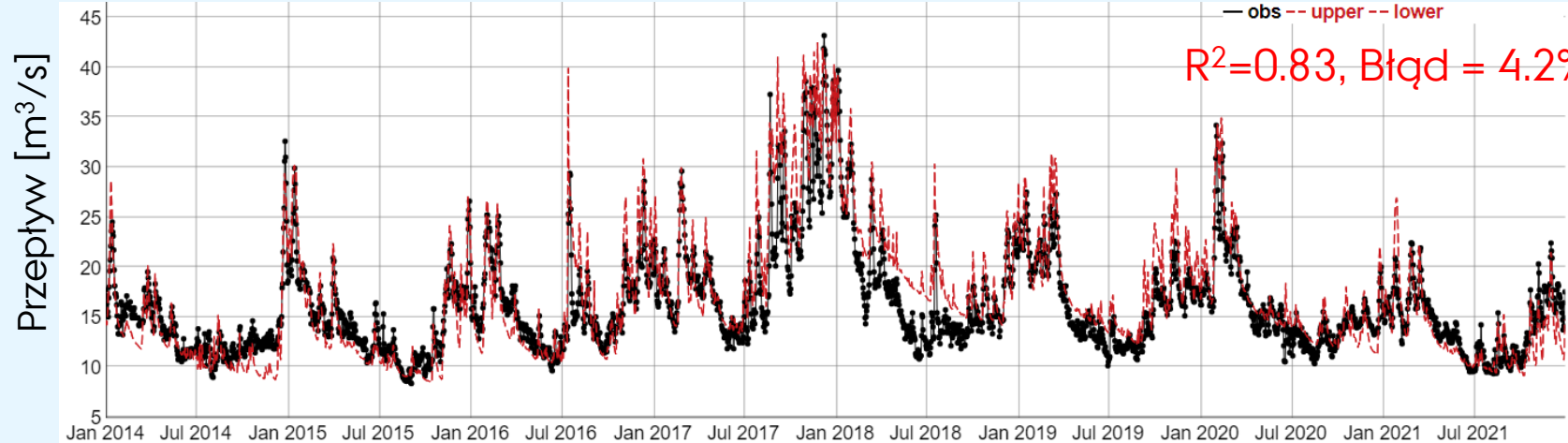

Głażna - ujście

Dane GIOŚ:
Śr. 3,5 mg/l
Min 1 mg/l
Max 5 mg/l

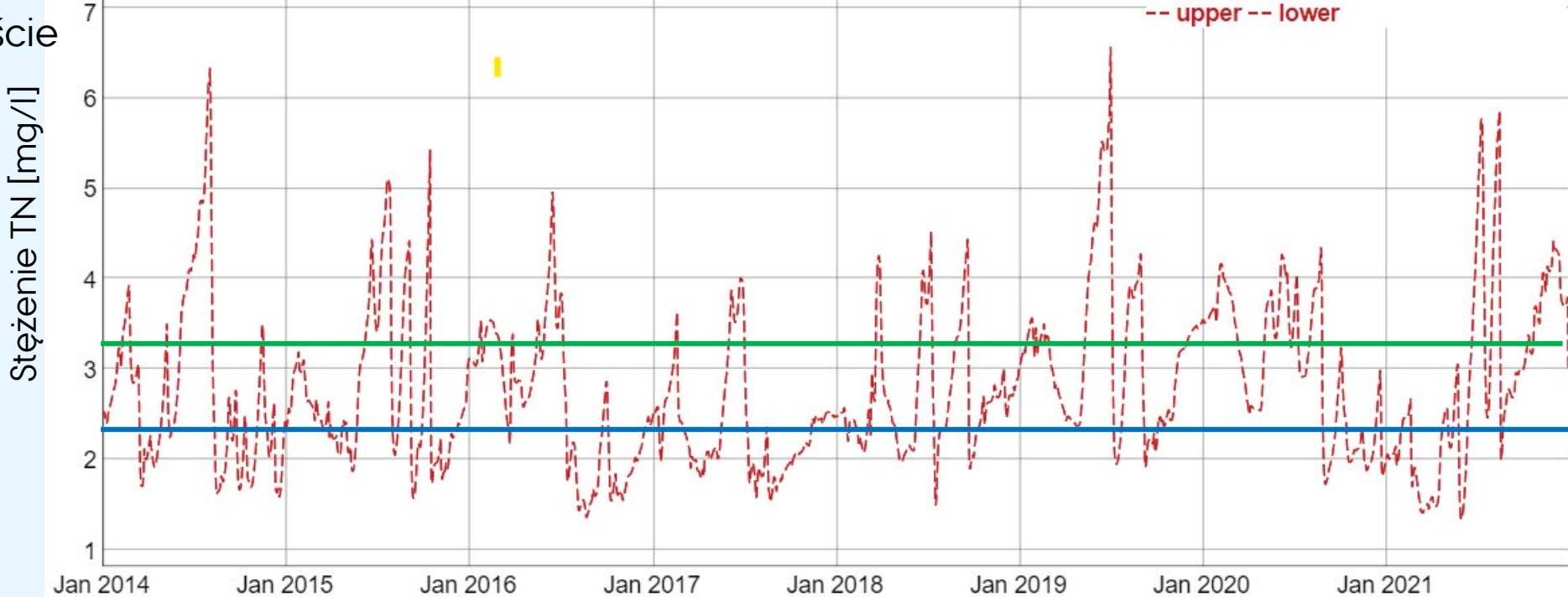

*granica stan dob./um.
(obecna)*

*granica stan dob./um.
(NORDBALT)*

Kamieniec - ujście

Dane GIOŚ:
Śr. 3 mg/l
Min 1 mg/l
Max 9 mg/l

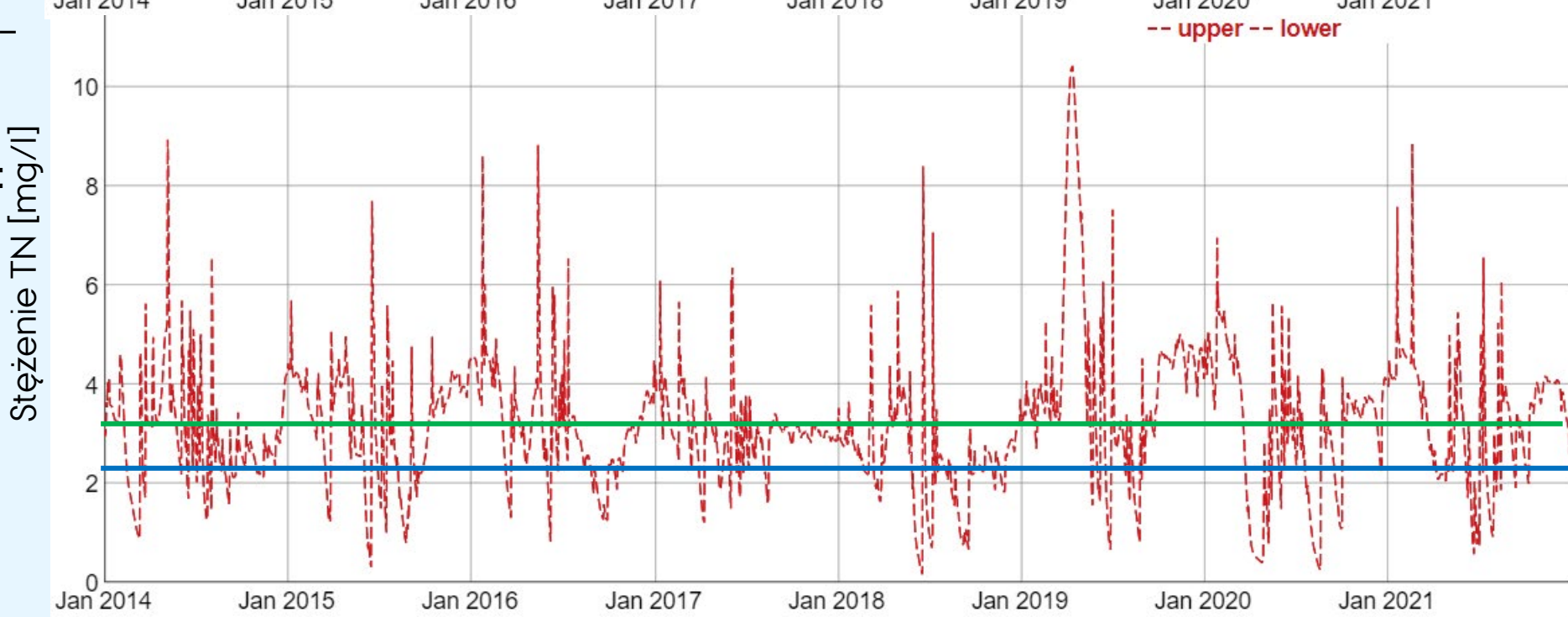

*granica stan dob./um.
(obecna)*

*granica stan dob./um.
(NORDBALT)*

Weryfikacja modelu (Słupia - Charnowo)

Dane obserwowane:

- > Przepływy (IMGW)
- > Stężenia $\text{PO}_4\text{-P}$ (GIOŚ)
- > Ładunki - obliczenia własne

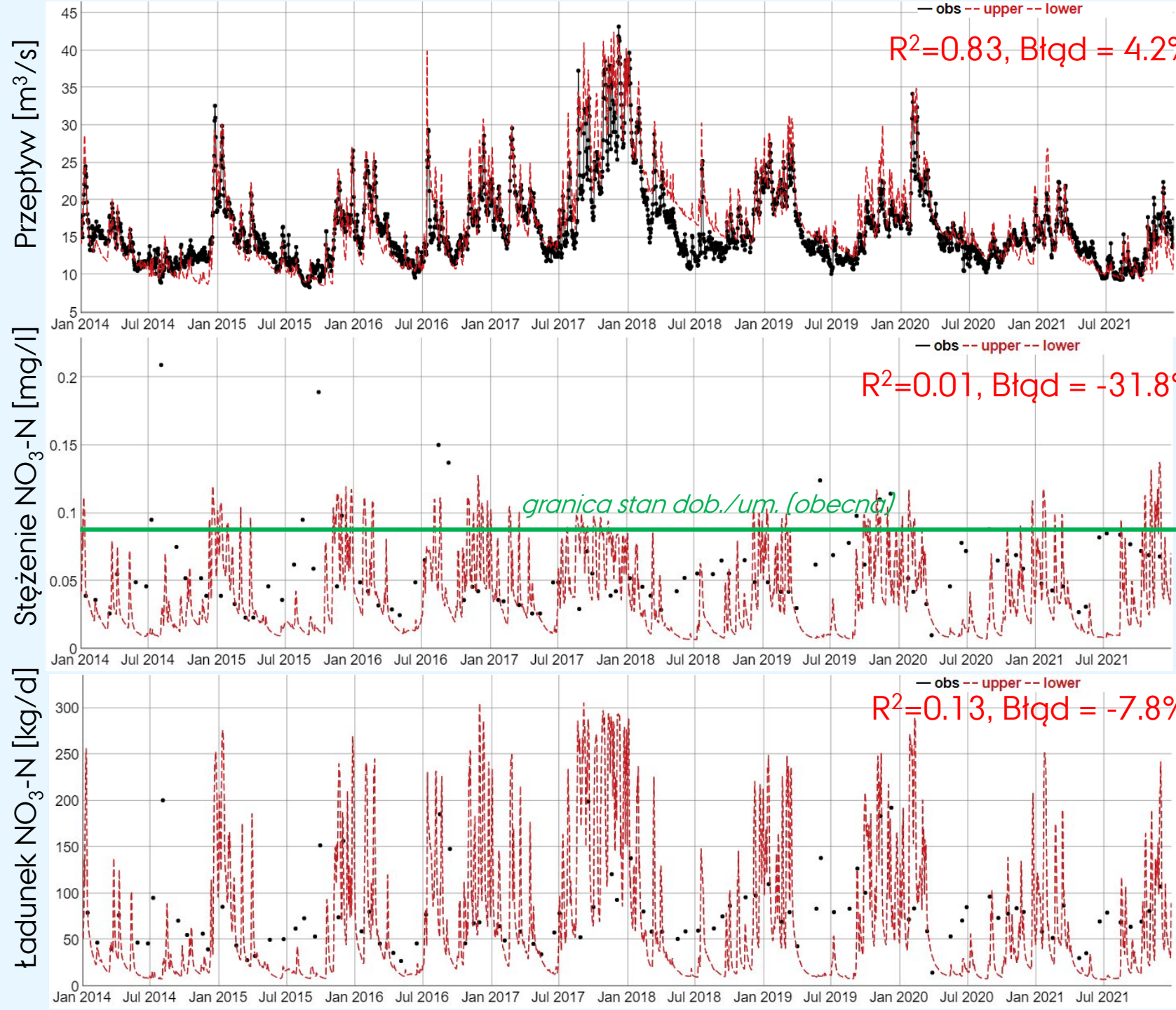



Bilans wodny zlewni Słupi

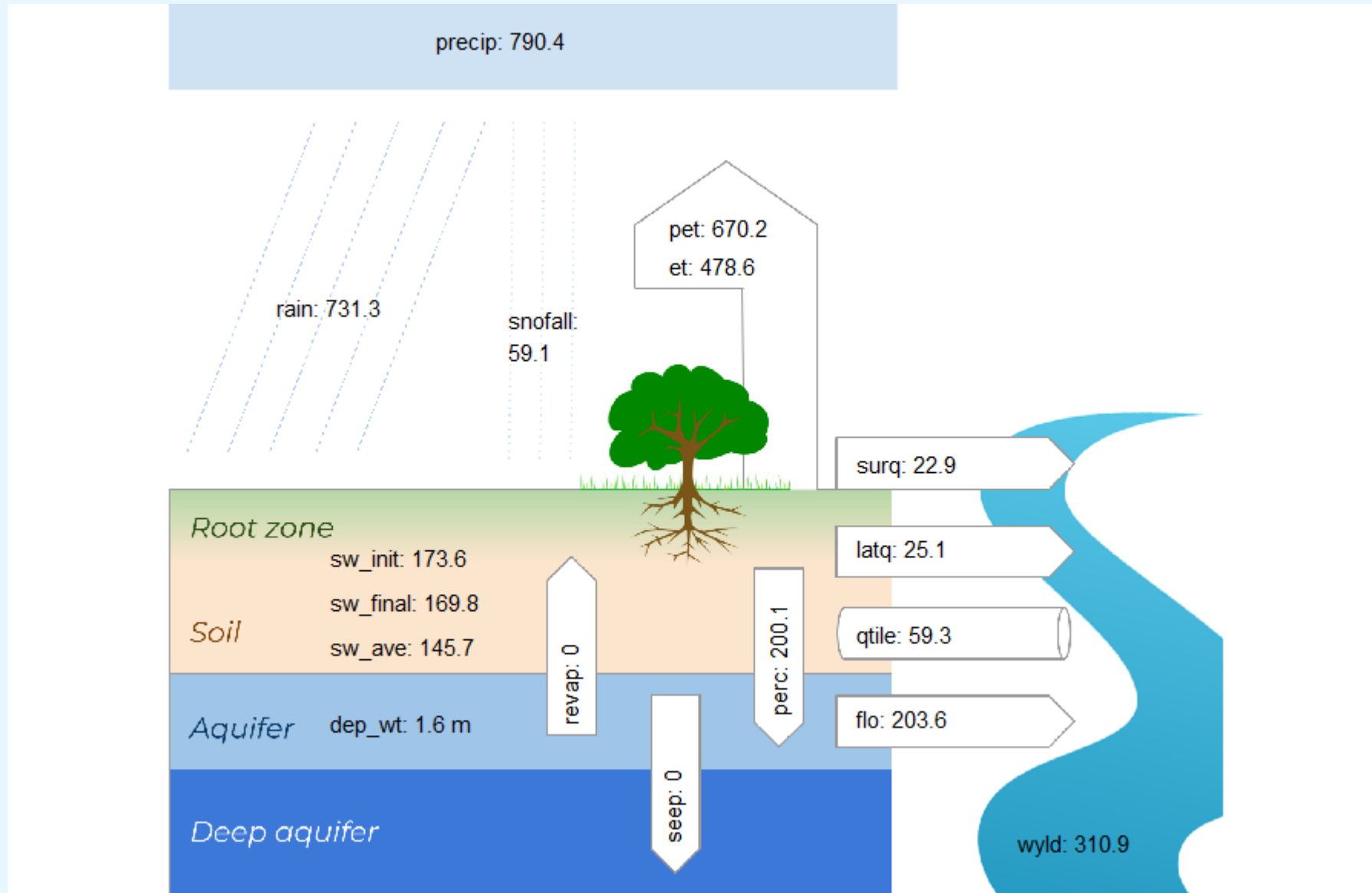

Bilans azotu w skali zlewni [kg/ha/rok]

Przychód

- › Nawożenie 29
- › Resztki roślin: 29
- › Wiązanie przez rośliny 15
- › Depozycja NO₃-N 7
- › Depozycja NH₄-N 6

Straty

- › Denitryfikacja 13
 - › Pobór przez rośliny 74
 - › Straty do wód 14
- ⇔
- › Perkolacja 10
 - › Dreny 1.5
 - › Odpływ podpowierzchniowy 1.5
 - › Sedymet 1
 - › Spływ powierzchniowy 0.5



AARHUS UNIVERSITY

Średnie ładunki jednostkowe azotu [kg/ha/rok]

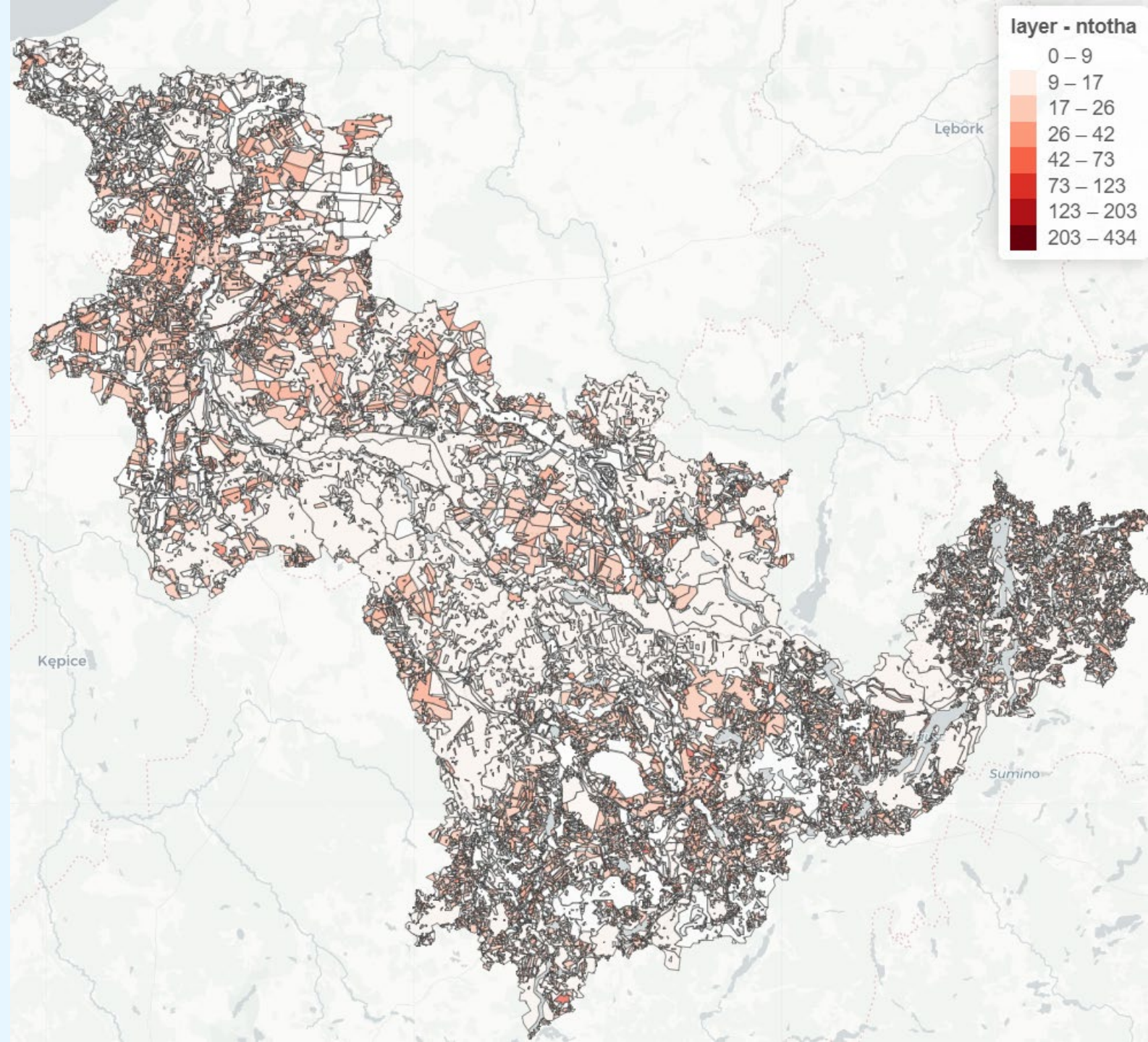



2019-01-31

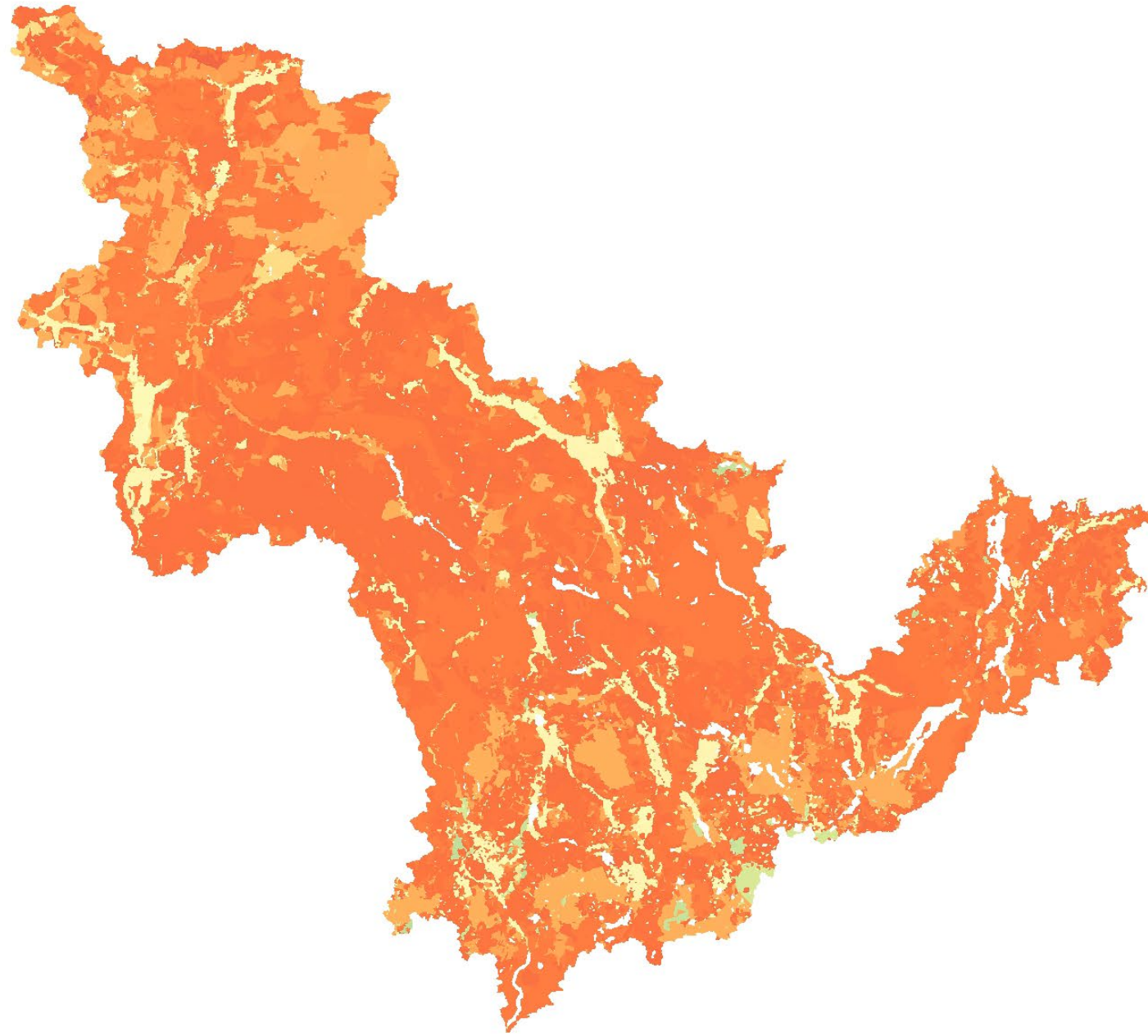

Zapas wody w glebie [0-300 mm]

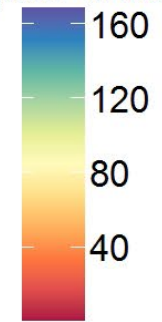

Propozycja katalogu działań ochronnych dla zlewni Słupi i wstępne wyniki modelowania ich efektywności

<https://projects.au.dk/nordbalt-ecosafe>

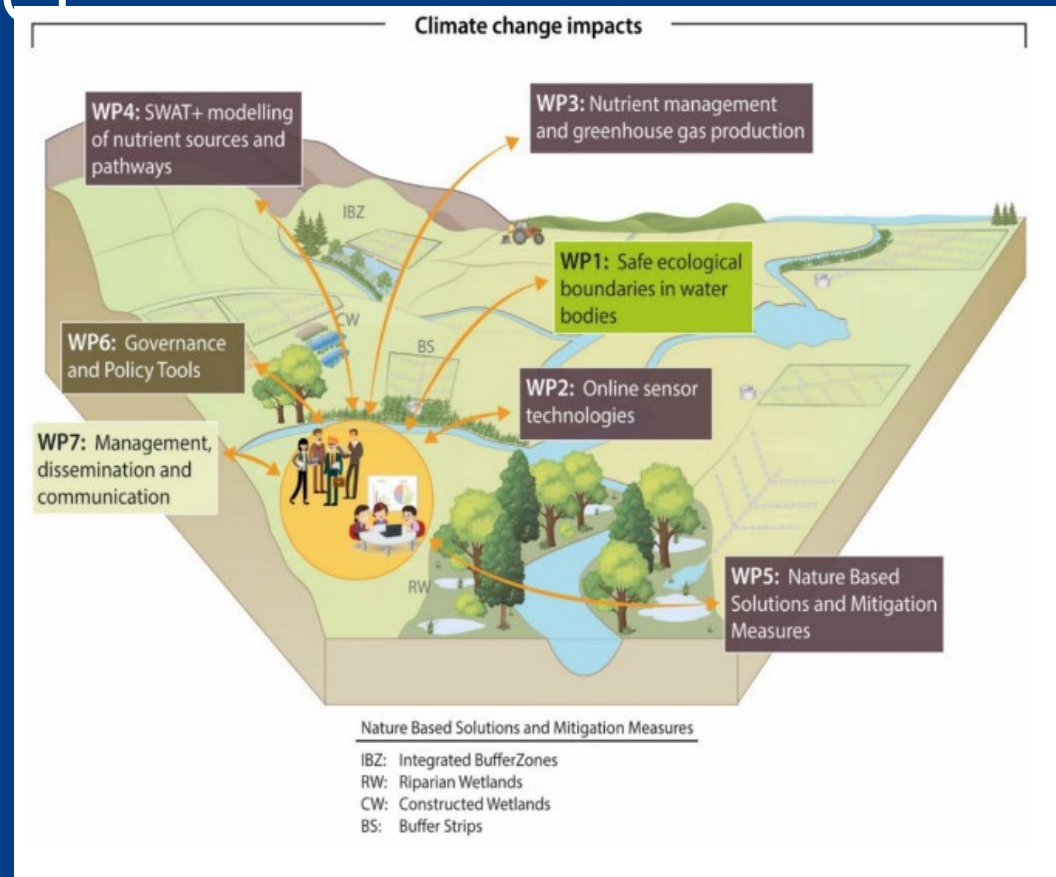

Zakres wystąpienia

- › Wykaz wszystkich działań zaproponowanych w projekcie
- › Kryteria wyboru działań dla zlewni Słupi
- › Propozycja działań dla Słupi
- › Dyskusja

Measure	Pathway				
	Surface runoff	Tile flow	Leaching from root zone	Groundwater flow	Stream flow
Field mitigation measures					
Catch crops		x	x	x	
Permanent set-aside	x	x	x	x	
Set-aside in rotation	x	x	x	x	
Permanent grassland, meadows and pastures	x	x	x	x	
Energy crops	x	x	x	x	
Afforestation	x	x	x	x	
Direct sowing	x	x	x	x	
No or delayed tillage in autumn	x		x		
Application of gypsum or structure lime			x		
Precision fertilization (fertilizer & manure)		x	x	x	
Reduced fertilizer use		x	x	x	
Manure application regulations (time and amount)	x	x	x	x	
Limits for N and P use in manure	x	x	x	x	
Transport mitigation measures					
Surface flow constructed wetlands (on fields)		x			
Restored wetlands		x		x	x
Bioreactors with wood chips		x			
Controlled drainage		x	x		
Inundation of meadows with drainage water		x			
Grass buffer strips	x				
Buffer strips with trees	x				x
Integrated and Saturated Buffer Zones	x	x			
Grassed waterways	x				
Grass cover/no tillage in areas with high flood and/or erosion risk	x				
In-stream mitigation measures					
Constructed wetlands					x
Retention ponds in forests	x				x
Re-meandering of river channels					x
Two stage ditches and channels					x
Bank stabilization					x
Stream bed re-naturalization					x

Pole

Ścieżki transportu

Koryto cieku

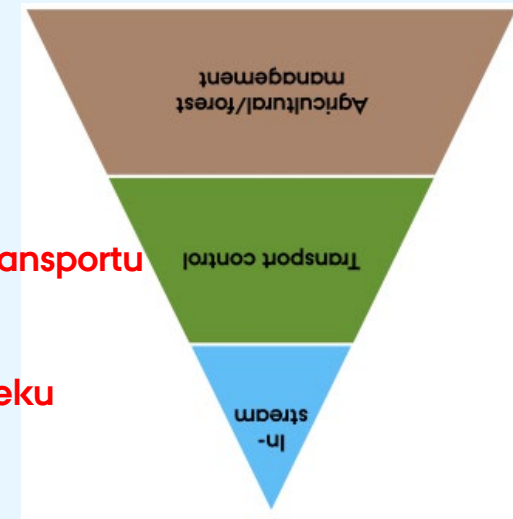

Zaproponowany projekcie Katalog działań redukcji biogenów

ścieżki transportu składników odżywczych, na które ukierunkowane są działania środki

Zaproponowany w projekcie Katalog działań redukcji biogenów

Współkorzyści i funkcje
"negatywne"

- Kontrola powodzi
- Łagodzenie skutków suszy
- Kondycja gleby
- Emisja metanu
- Emisje N₂O
- Sekwestracja dwutlenku węgla
- Zużycie paliw kopalnych
- Retencja osadów
- Bioróżnorodność
- Emisje fosforanów z gleby

Measure	Co-benefits and disservices									
	Flood control	Drought mitigation	Soil health	Methane emissions	N ₂ O emissions	Carbon sequestration	Consumption of fossil fuels	Sediment retention	Biodiversity	Phosphate emissions from soils
Field mitigation measures										
Catch crops	0	0	+	0	+	+	-	+	+	+
Permanent set-aside	0	0	+	0	+	+	-	+	+	0
Set-aside in rotation	0	0	+	0	0	0	-	+	0	0
Permanent grassland, meadows and pastures	+	0	+	0	+	+	-	+	+	+
Energy crops	0	0	0	0	0	+	-	+	+	+
Afforestation	0	0	+	0	+	+	-	+	+	+
Direct sowing	0	0	+	0	0	+	-	+	+	0
No or delayed tillage in autumn	0	0	+	0	0	0	-	+	+	0
Application of gypsum or structure lime	0	0		0	0	0	+	+	0	+
Precision fertilization (fertilizer & manure)	0	0	+	0	0	+	0	0	0	+
Reduced fertilizer use	0	0	0	0	+	0	0	0	0	+
Manure application regulations (time and amount)	0	0	0	0	+	0	0	0	0	+
Limits for N and P use in manure	0	0	0	0	+	0	0	0	0	+
Transport mitigation measures										
Surface flow constructed wetlands (on fields)	0	0	0	-	-	0	0	+	+	0
Restored wetlands	+	+	+	-	-	+	-	+	+	+
Bioreactors with wood chips	0	0	0	-	-	-	0	+	0	-
Controlled drainage	+	+	+	0	0	0	0	+	0	+
Inundation of meadows with drainage water	+	+	+	-	-	+	-	+	+	-
Grass buffer strips	0	0	+	0	0	+	-	+	+	0
Buffer strips with trees	0	0	+	0	0	+	-	+	+	0
Integrated and Saturated Buffer Zones	0	0	+	0	0	+	-	+	+	0
Grassed waterways	+	0	+	0	0	+	-	+	+	0
Grass cover/no tillage in areas with high flood and/or erosion risk	0	0	+	0	0	+	-	+	+	0
In-stream mitigation measures										
Constructed wetlands	0	0	n/a	-	0	0	n/a	+	+	0
Retention ponds in forests	+	0	n/a	0	0	0	n/a	+	+	0
Re-meandering of river channels	+	+	n/a	0	0	0	n/a	-	+	-
Two stage ditches and channels	+	0	n/a	0	0	0	n/a	+	+	0
Bank stabilization	0	0	n/a	0	0	0	n/a	+	0	0
Stream bed re-naturalization	0	0	n/a	0	0	0	n/a	0	+	0

Measure	Implementation barriers								
	Lack of knowledge about measure	Loss of agricultural land	Limited availability of suitable land	High economic investment	Lack of subsidies	Complicated administrative processes	Ineffective or unclear regulations and policies	Lack of design and implementation guidance	Regular maintenance needs
Field mitigation measures									
Catch crops	NO, LV			DK	NO	LV		LV	DK, PL
Permanent set-aside		DK, SE, PL		DK					
Set-aside in rotation		SE, PL							
Permanent grassland, meadows and pastures							LV		LV
Energy crops		DK, PL						PL	PL
Afforestation		PL							PL
Direct sowing	NO, LV, PL		SE	NO, LV, PL	NO	NO		NO	
No or delayed tillage in autumn			NO, SE		NO				NO
Application of gypsum or structure lime	FI, LV		SE, FI					LV	
Precision fertilization (fertilizer & manure)	LV			LV, PL				LV	
Reduced fertilizer use						PL			
Manure application regulations (time and amount)				LV, PL		LV			PL
Limits for N and P use in manure				LV		LV			
Transport mitigation measures									
Surface flow constructed wetlands (on fields)		DK, SE	SE	SE		DK, SE	SE		
Restored wetlands	PL	DK, PL				DK		PL	
Bioreactors with wood chips									
Controlled drainage	DK		SE	SE	DK		DK	DK	DK, PL
Inundation of meadows with drainage water		SE							
Grass buffer strips	DK, LV	DK, NO, SE, LV	NO, SE, PL	NO, LV	DK, NO	LV		NO	DK, NO, LV
Buffer strips with trees	NO	NO, PL	NO		NO		NO	NO	NO, PL
Integrated and Saturated Buffer Zones	SE				DK				
Grassed waterways	NO, PL	NO, SE, PL	SE	NO	NO		PL		NO
Grass cover/no tillage in areas with high flood and/or erosion risk	LV	SE, PL			NO	LV		NO, LV	
In-stream mitigation measures									
Constructed wetlands	NO, LV, PL	SE, FI, LV, PL	SE, LV	NO, SE, LV		SE, LV	SE	NO, LV, PL	NO, FI, LV, PL
Retention ponds in forests					SE				PL
Re-meandering of river channels		PL	PL	PL	PL	PL	PL	PL	PL
Two stage ditches and channels	SE, FI	(FI), PL	SE, FI	SE		SE			FI
Bank stabilization									
Stream bed re-naturalization	PL				PL		PL		

Przeszkody we wdrażaniu

1. Brak wiedzy na temat działania
2. Utrata gruntów rolnych
3. Ograniczona dostępność odpowiedniego gruntu
4. Wysokie inwestycje gospodarcze
5. Brak dotacji
6. Skomplikowane procesy administracyjne
7. nieskuteczne lub niejasne przepisy i zasady
8. Brak wskazówek dotyczących projektowania i wdrażania
9. Regularne potrzeby konserwacyjne

Figure 5: Implementation barriers according to the expert knowledge of the NORDBALT-ECOSAFE consortium

TRAWIASTE STREFY BUFOROWE



Pasy buforowe są tworzone między polami a zbiornikami wód powierzchniowych. Trwała roślinność spowalnia spływ powierzchniowy, co powoduje osadzenie się osadów i składników odżywczych związanych z osadami oraz infiltrację rozpuszczonych składników odżywczych do gleby, gdzie mogą one zostać usunięte lub zaadsorbowane na cząstkach gleby

Pasy buforowe są zatwierdzone jako krajowy środek łagodzący i dotowane w Danii (DK), Norwegii (NO), Szwecji (SE), Finlandii (FI), na Łotwie (LV) i w Polsce (PL)

Wpływ na usuwanie składników odżywczych

Skuteczność usuwania substancji odżywczych jest ważnym kryterium wyboru odpowiedniego środka. Skuteczność usuwania składników odżywczych przez pasy buforowe zależy w dużej mierze od ich szerokości i rodzaju roślinności, ale może być również uzależniona od rodzaju gleby i nachylenia

Tabela1 : Skuteczność usuwania składników odżywczych przez paski buforowe

	DK	NIE	SE	FI	LV	PL
Skuteczność usuwania azotu [%]		16; 31; 78-89				7-99
Skuteczność usuwania fosforu [%]	32-74	23; 34; 76-89	5	27-97		76-81

Projektowanie i wdrażanie

Tabela2 : Szerokość, roślinność i utrzymanie pasów buforowych

	Szerokość	Roślinność	Konserwacja
DK	3 m wzdłuż publicznych cieków wodnych	Trawy lub zioła	Wymagane coroczne cięcie bez usuwania biomasy
NIE	Obowiązkowe: 2 m naturalnego BS; opcjonalnie: 5-6 m (łąka) -10-12 m (pole) trawiastego BS lub 20 m pola zboża na ściernisku.	trawy, zioła, krzewy, drzewa	Naturalne BS: opcjonalna wycinka pojedynczych drzew; pokryte trawą BS: wymagana wycinka z lub bez usuwania biomasy
SE	6 m	trawy, do 15% roślin wiązujących N	Dozwolone koszenie trawy (z wyjątkiem okresu od 1 kwietnia do 30 czerwca)
FI	3 m	trawy	Coroczne koszenie i usuwanie roślinności przed 31 sierpnia, dozwolony wypas
LV	4 m wzdłuż rowów; 8 m wzdłuż strumieni i rzek	trawy, dzikie kwiaty, konopie, słoneczniki	Coroczne przycinanie i usuwanie roślinności przed 15 września
PL	3 m, gdy jest pokryty roślinnością, lub 5 m dla wszystkich naturalnych cieków wodnych, zbiorników i rowów o szerokości do 5 m, 20 m dla dużych jezior i wybrzeża morskiego.	nie określono	Szczególne ograniczenia dotyczą głównie zakazu stosowania nawozów i pestycydów

Obowiązkowa szerokość bufora jest największa w Norwegii, a także szersza w Szwecji i na Łotwie niż w innych krajach. W większości krajów roślinność jest ograniczona do traw, ziół lub dzikich kwiatów, ale krzewy i drzewa są dozwolone w Norwegii (ale nie są dotowane) i Polsce. W Szwecji trawa może być mieszana z roślinami wiążącymi azot, podczas gdy na Łotwie można sadzić rośliny oleiste.

Barьеры we wdrażaniu

Barьеры wdrożeniowe mogą utrudniać stosowanie środków ograniczających emisję substancji biogennych, nawet jeśli mają one wysoką skuteczność redukcji substancji biogennych i są odpowiednie dla lokalnych warunków środowiskowych. Porównania między krajami mogą ujawnić potencjał uczenia się od innych krajów i zwiększyć prawdopodobieństwo wdrożenia danego środka

Tabela3 : Barьеры we wdrażaniu pasków buforowych

	DK	NIE	SE	FI	LV	PL
Brak wiedzy na temat środka	x				x	
Utrata gruntów rolnych	x	x	x		x	
Ograniczona dostępność odpowiednich gruntów		x	x			x
Wysokie inwestycje gospodarcze		x			x	
Brak dotacji	x	x				
Skomplikowane procesy administracyjne					x	
Nieskuteczne lub niejasne regulacje lub polityki						
Brak wytycznych dotyczących projektowania i wdrażania		x				
Potrzeby w zakresie regularnej konserwacji	x	x			x	

Utrata gruntów rolnych jest istotną barьерą we wdrażaniu w prawie wszystkich krajach. Dania, Łotwa, a zwłaszcza Norwegia stoją w obliczu większej liczby barьер niż Szwecja, Finlandia i Polska.

Dodatkowe korzyści i usługi

Przy wyborze środka ważne jest unikanie kompromisów lub zamiany zanieczyszczeń oraz rozważenie dodatkowych korzyści, które mogą zwiększyć opłacalność środków.

Tabela4 : Dodatkowe korzyści i wady pasów buforowych zgodnie z wiedzą ekspercką konsorcjum NORDBALT-ECOSAFE ("-" oznacza wpływ negatywny, "+" oznacza wpływ pozytywny, a "0" oznacza brak wpływu lub wpływ marginalny).

Kontrola powodzi	0	
Łagodzenie skutków suszy	0	
Zdrowie gleby	+	
Emisja metanu*	0	
Emisje N ₂ O*	0	
Sekwestracja dwutlenku węgla	+	
Zużycie paliw kopalnych	-	
Retencja osadów	+	
Bioróżnorodność**	+	
Emisje fosforanów z gleby	0	

Pasy buforowe mają pozytywny wpływ na zdrowie gleby, sekwestrację dwutlenku węgla, retencję osadów i bioróżnorodność, ale mogą powodować zwiększone zużycie paliw kopalnych.

NORDBALT
ECOSAFE

Przykład arkusza informacyjnego dla stref buforowych

Kryteria wyboru działań dla konkretnego obszaru

Naturalne uwarunkowania (spadek, przepuszczalność gruntu, bilans klimatyczny) oraz istniejące użytkowanie

Kryterium	Opis
KOSZTY	Koszt definiowany w kategoriach ograniczeń ekonomicznych w wyborze działań. Powinien on uwzględniać wszystkie aspekty "od kołyski do grobu". W tym: - efektywność kosztową: np. w sensie ilości (m ³); - zapotrzebowanie na teren
	Ocena: im tańsze działania, tym bardziej preferowane
WIELOFUNKCYJNOŚĆ I EFEKT EKOLOGICZNY	Wielofunkcyjność, rozumiana jako zdolność do zapewnienia również innych funkcji, dla których działania nie zostało specjalnie zaprojektowane.
	Ocena: im większa funkcjonalność tym działanie bardziej preferowane
ODPORNOŚĆ	Jest on rozumiany jako zdolność działań do radzenia sobie z wymuszeniami zewnętrznymi, które nie zostały zaplanowane lub na które nie ma wpływu niepewność na etapie projektowania (np. zmiana klimatu lub zmiana użytkowania gruntów w otoczeniu).
	Ocena: im solidniejsze działanie tym działanie bardziej preferowane
CZAS TRWANIA I ZŁOŻONOŚĆ WDROŻENIA	Czas trwania wdrożenia jest bardzo złożony i może być postrzegany jako bariera realizacji. Czas trwania to czas niezbędny do wdrożenia działania do momentu, w którym środek jest skuteczny. Powinien on obejmować wszystkie aspekty: np. zapewnienie akceptacji społecznej, wyłączenia, kwestie administracyjne, oraz realizację. Niektóre środki, raz wdrożone, muszą być wdrażane przez cały czas w przyszłości, ale dla ich pierwszego wdrożenia w większości przypadków wymagany jest jedynie krótki horyzont czasowy: Powinniśmy skupić się na drugim aspekcie "czasu trwania".
	Ocena: im krótszy i łatwiejszy proces wdrażania, tym działanie bardziej preferowane

[System Wsparcia Decyzji m.in. wyboru działań](#)

Wstępny wybór działań



Wstępny wybór działań dla zlewni Słupi

Nazwa	Uwagi po spotkaniu 30.08.2024
Działania łagodzące na polu	
Poplony*	Akceptowalne i stosowane przez rolników
Wczesny wysiew upraw ozimych	Niestosowane
Odłogowanie w płodozmianie*	Nieopłacalne
Zalesianie	Duży program zalesień ARiMR
Uprawa uproszczona i siew bezpośredni*	Akceptowalne i stosowane przez rolników (niekoniecznie z siewem bezpośrednim)
Uprawa bezorkowa*	Mniej chętnie stosowane od (problemy z zachwaszczeniem)
Regulacje dotyczące stosowania obornika*	Wymagane są plany nawozowe (m.in. limit 170 kg NPK) ale niekoniecznie realizowane w praktyce; od 2025 elektroniczny rejestr zabiegów agrotechnicznych
Mulczowanie*	Bardzo powszechnie stosowane ze względu na niewielką produkcję zwierzęcą
Płodozmiian*	Powszechnie stosowany w dużych gospodarstwach, rzadziej w małych
Działania spowalniające transport biogenów	
Regulowany odpływ z systemów melioracyjnych	Systemy melioracyjne są zaniedbane, niewielkie zainteresowanie
Odtworzone tereny podmokłe	Niewielkie zainteresowanie (proces odwrotny – zabudowa pod tereny rekreacyjne)
Trawiaste pasy buforowe	Wzdłuż Słupi nie ma problemu, na mniejszych dopływach rolnicy niechętnie zmieniają zagospodarowanie
Zadrzewienia przybrzeżne	Obowiązuje zakaz cięcia w pasie przybrzeżnym na terenie PK
Działania łagodzące w korycie cieku	
Tworzenie sztucznych mokradeł	Brak zainteresowania
działania związane z ekoschematami Renaturyzacja koryta rzeki/cieku	Jedyny znany projekt na Kwaczy, były problemy z zamulaniem zrenaturyzowanych odcinków

Deklaracje rolników chęci zastosowania ekoschematów dla roku 2023 (źródło: ARiMR)

Opis	Gr.orne	Użyt. Rolne	E_BOU	E_OBR	E_PN	E_WSG	E_MPW	E_USU	E_OPN	E_ZSU	RAZEM
Liczność	14691	24886	79	1606	715	1611	2423	1174	3655	6574	15414
Powierzchnia ha	45685	59605	0	2996	3625	7339	7859	11875	13725	19341	58901
Udział w liczności gr.ornych			1%	11%	5%	11%	16%	8%	25%	45%	62%
Udział w powierzchni gr.ornych			0%	7%	8%	16%	17%	26%	30%	42%	99%

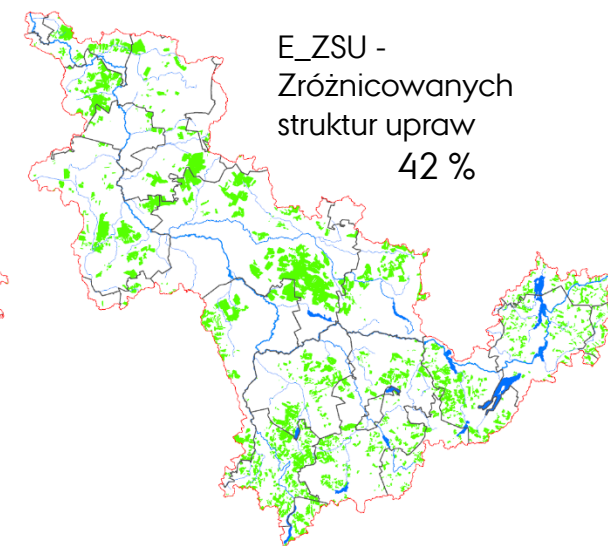
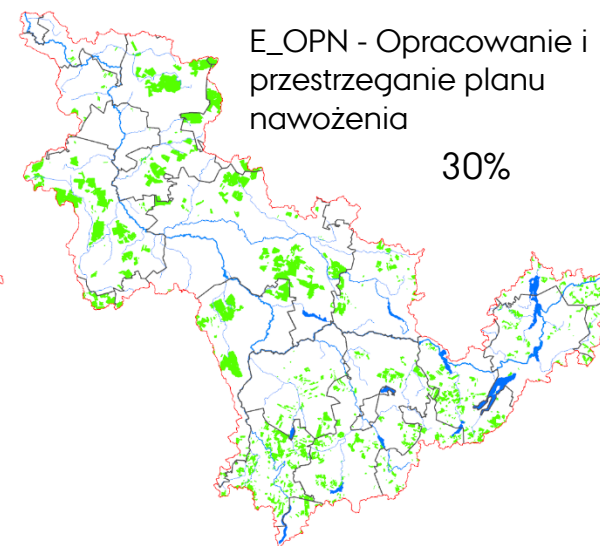
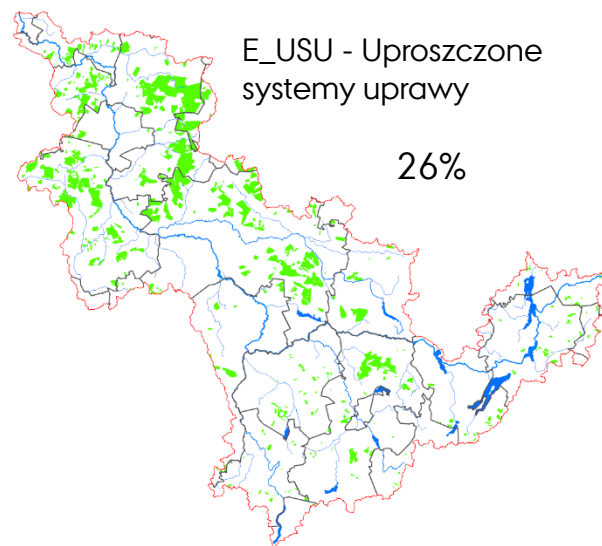
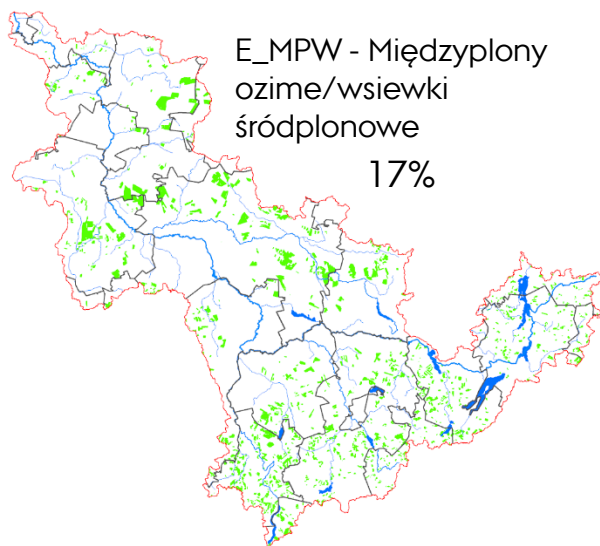
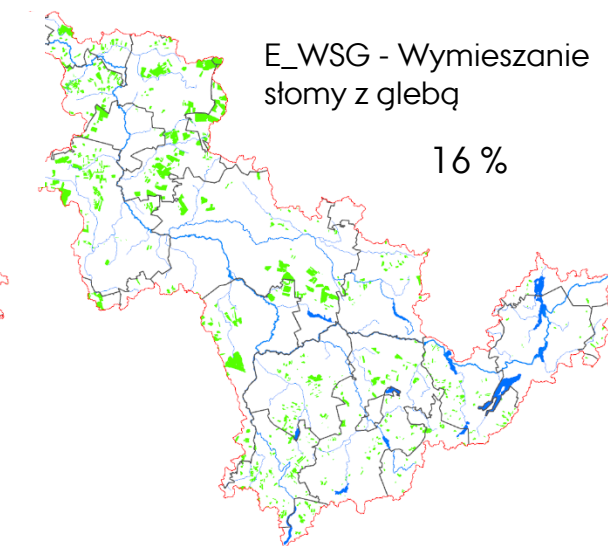
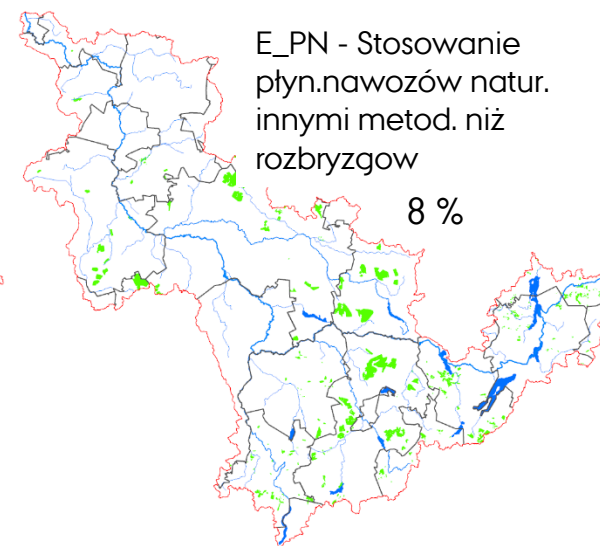
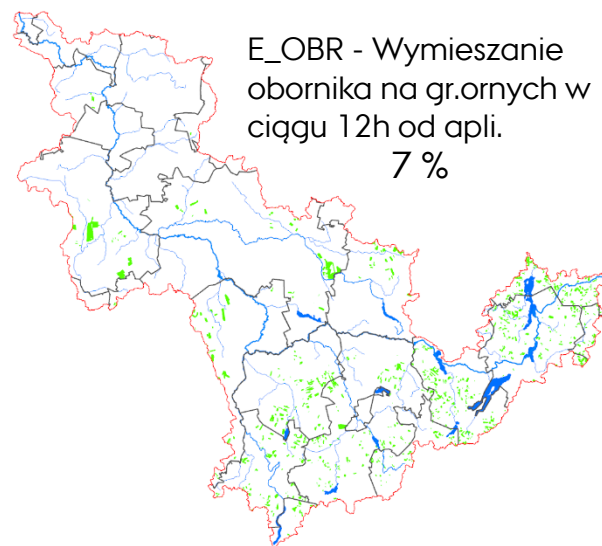
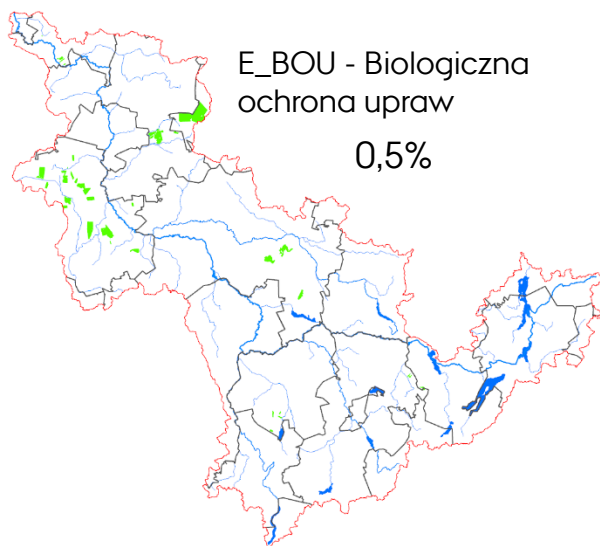

Gospodarka wodno-ściekowa – uwagi po spotkaniu 30.08.2024

- › **Oczyszczalnia ścieków w Słupsku – konieczność modernizacji w perspektywie 2040/2050 (czwarty stopień oczyszczania, dyrektywa ściekowa) i ograniczyć stężenia TN (8/9 => 6 mg/l) i TP (0,6 => 0,5 mg/l)**
- › **Spośród pozostałych większych oczyszczalni największych inwestycji wymaga Dębica Kaszubska, w drugiej kolejności Bytów i Ustka**
- › Ustanowienie stref ochrony pośredniej ujęć wody (m.in. wokół Słupska) w celu ograniczenia zanieczyszczenia azotem (restrykcje dotyczące nawożenia)
- › Rozwój zabudowy (głównie rekreacyjnej) wzdłuż rzek (m.in. Głaźna) i wokół jezior => nielegalne zrzuty ścieków (trudność z uwzględnieniem w modelu)

Scenariusze modelowe

- › **S0: Scenariusz bazowy (referencyjny, 2003-2023)**
- › **S1: Modernizacja oczyszczalni ścieków komunalnych**
- › **S2: Międzyplony ozime + uprawa uproszczona**
- › **S3: Płodozmian**
- › **S4: Ograniczenie nawożenia**
- › **S5: Zamiana gruntów ornych na łąki**

Ocena efektywności działań poprzez porównanie wyników symulacji scenariuszy S1-S5 ze scenariuszem bazowym S0 (różnice, zmiany procentowe)

S1: Założenia

- › Konieczność modernizacji w perspektywie 2040/2050 (czwarty stopień oczyszczania, dyrektywa ściekowa)
- › Ograniczenie stężeń wód pościekowych TN ($8/9 \Rightarrow 6 \text{ mg/l}$) i TP ($0,6 \Rightarrow 0,5 \text{ mg/l}$)
- › W modelu: ograniczenie wielkości ładunków z oczyszczalni o 30% (formy azotu) i 25% (formy fosforu)

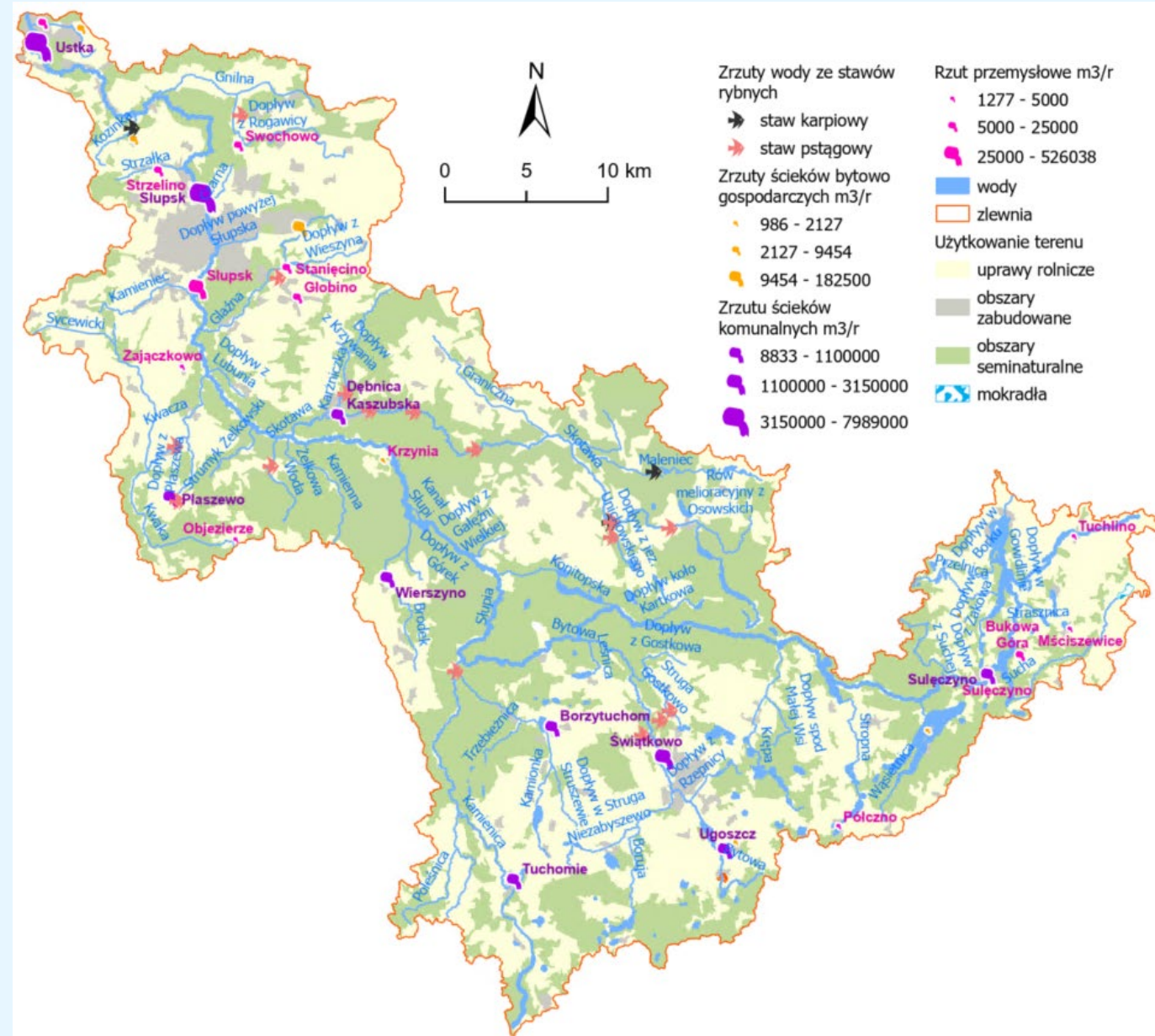

S1 (modernizacja OŚ): Wyniki

- › **Zmiana procentowa średniego ładunku TN w ciekach**

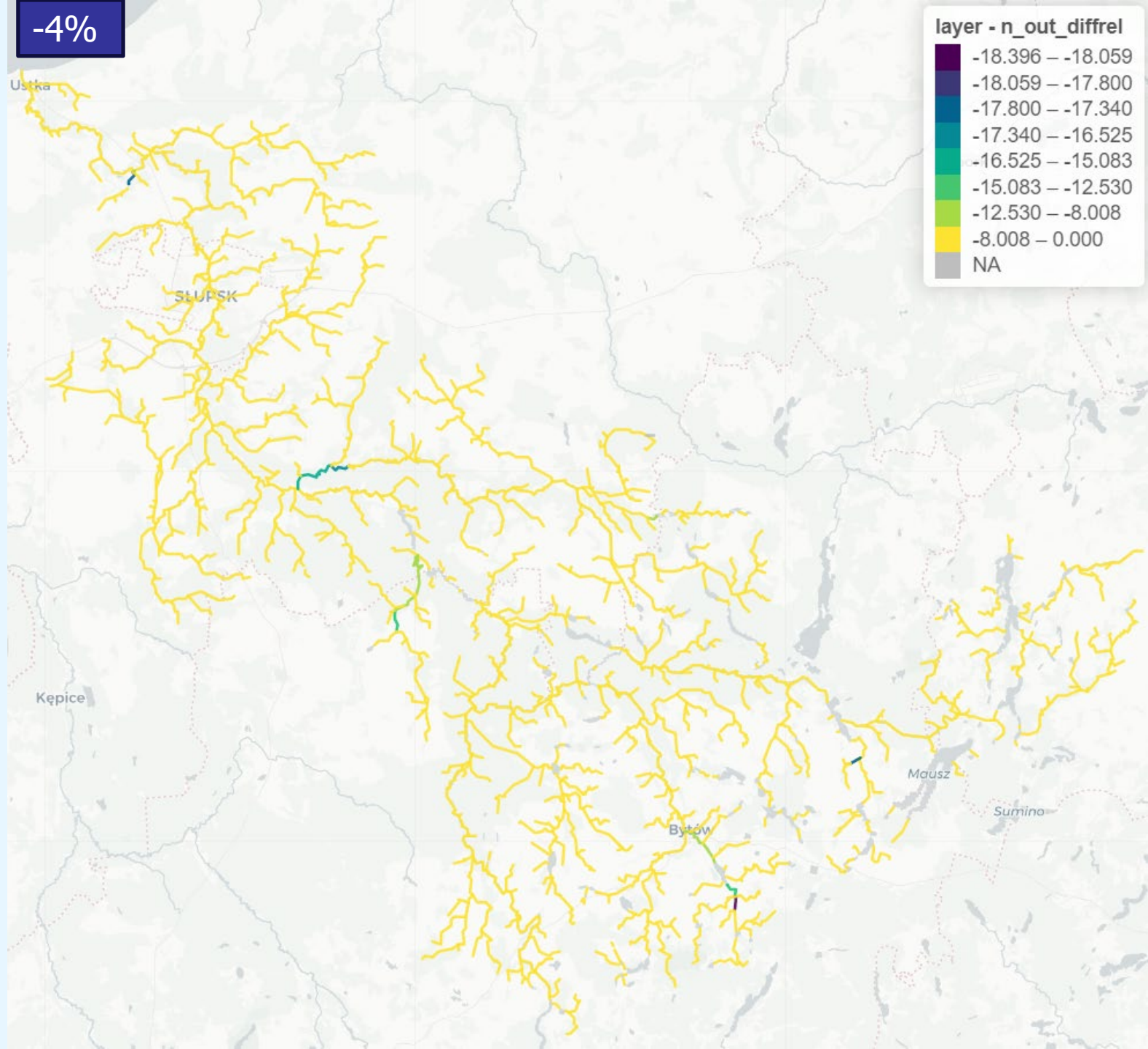

S2: Założenia

- › **Międzyplon ozimy (żyto) dodany do kalendarzy zabiegów agrotechnicznych w modelu po plonie głównym roślin jarych (mieszanek zbożowych, kukurydzy, ziemniaka i gryki)**
- › **Data siewu wrzesień/październik**
- › **Data zbioru luty/marzec**
- › **W połączeniu z uprawą uproszczoną (w modelu zmiana typu i głębokości orki)**
- › **Skala zastosowania zmienna w latach (zależna od struktury upraw) – średnio 20% użytków rolnych**

S2 (międzyplony): Wyniki

- › Zmiana sumarycznych strat azotu z pól (kg/ha)
- › Zmiana procentowa średniego ładunku TN w

-2%

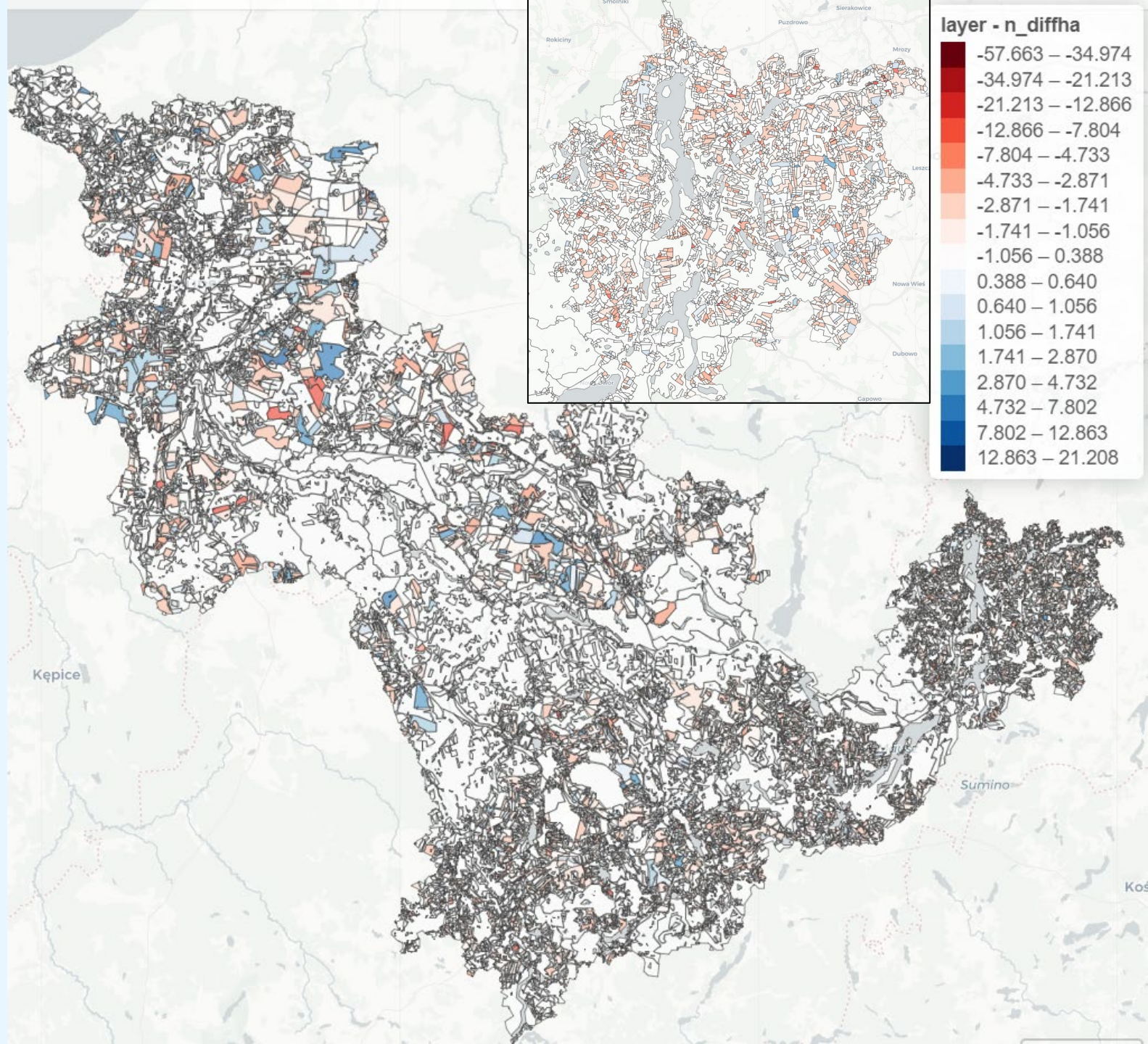
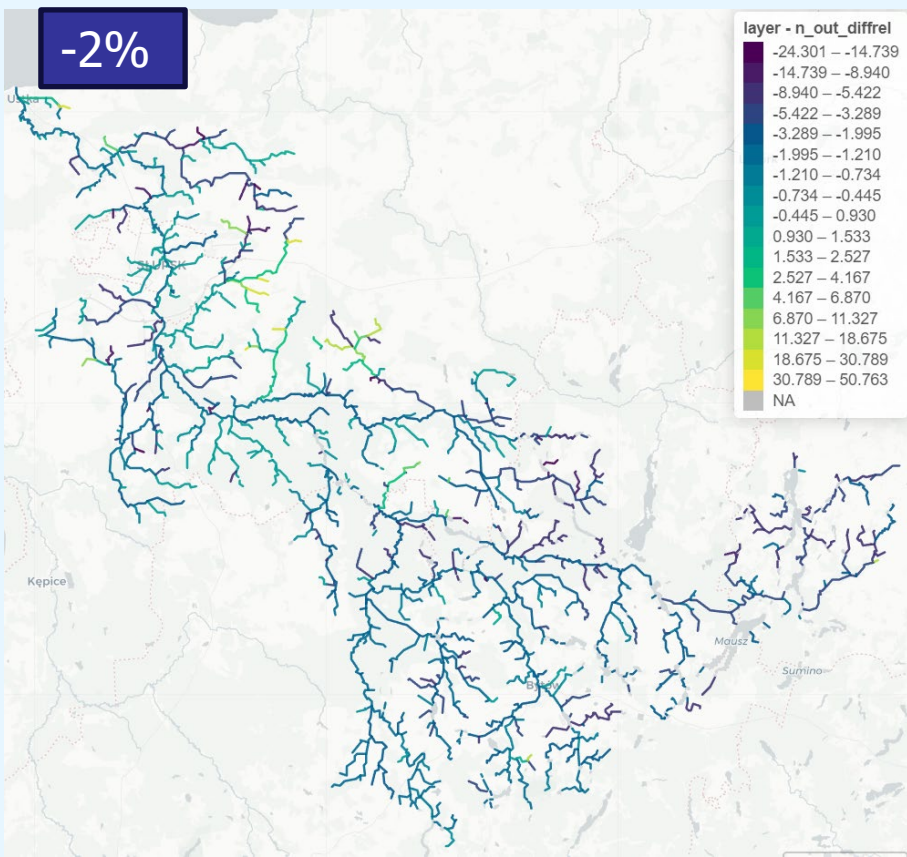

S3: Założenia

- › Wprowadzenie płodozmianu w miejsce monokultur o długości co najmniej 3 lat
- › W modelu: modyfikacja kalendarzy zabiegów agrotechnicznych – głównie zbóż i kukurydzy (też ziemniaków i rzepaku)
- › Groch zastosowany jako dodatkowa roślina w płodozmianie

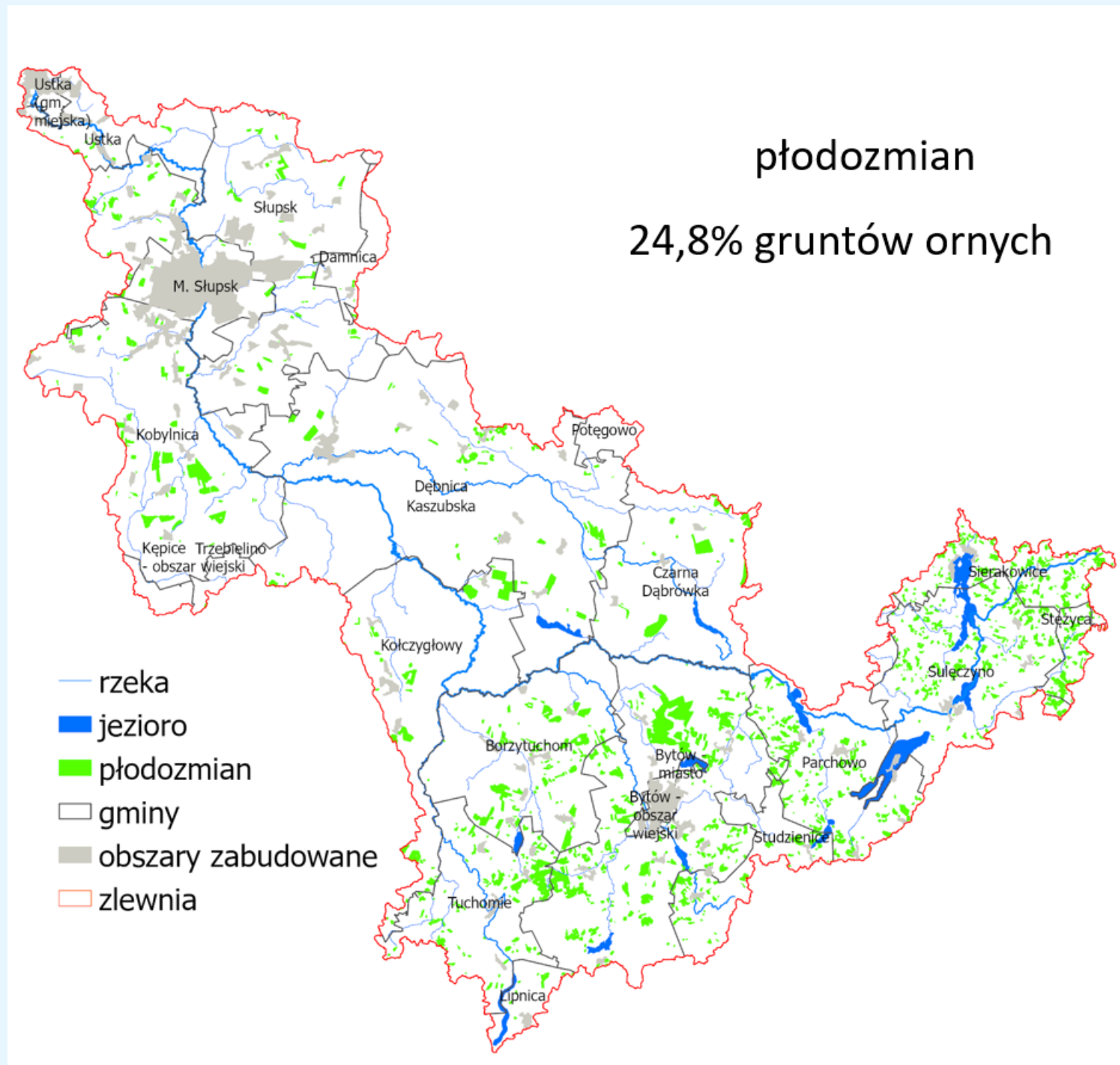

S3 (płodozmian): Wyniki

- › Zmiana sumarycznych strat azotu z pól (kg/ha)
- › Zmiana procentowa średniego ładunku TN w

-1%

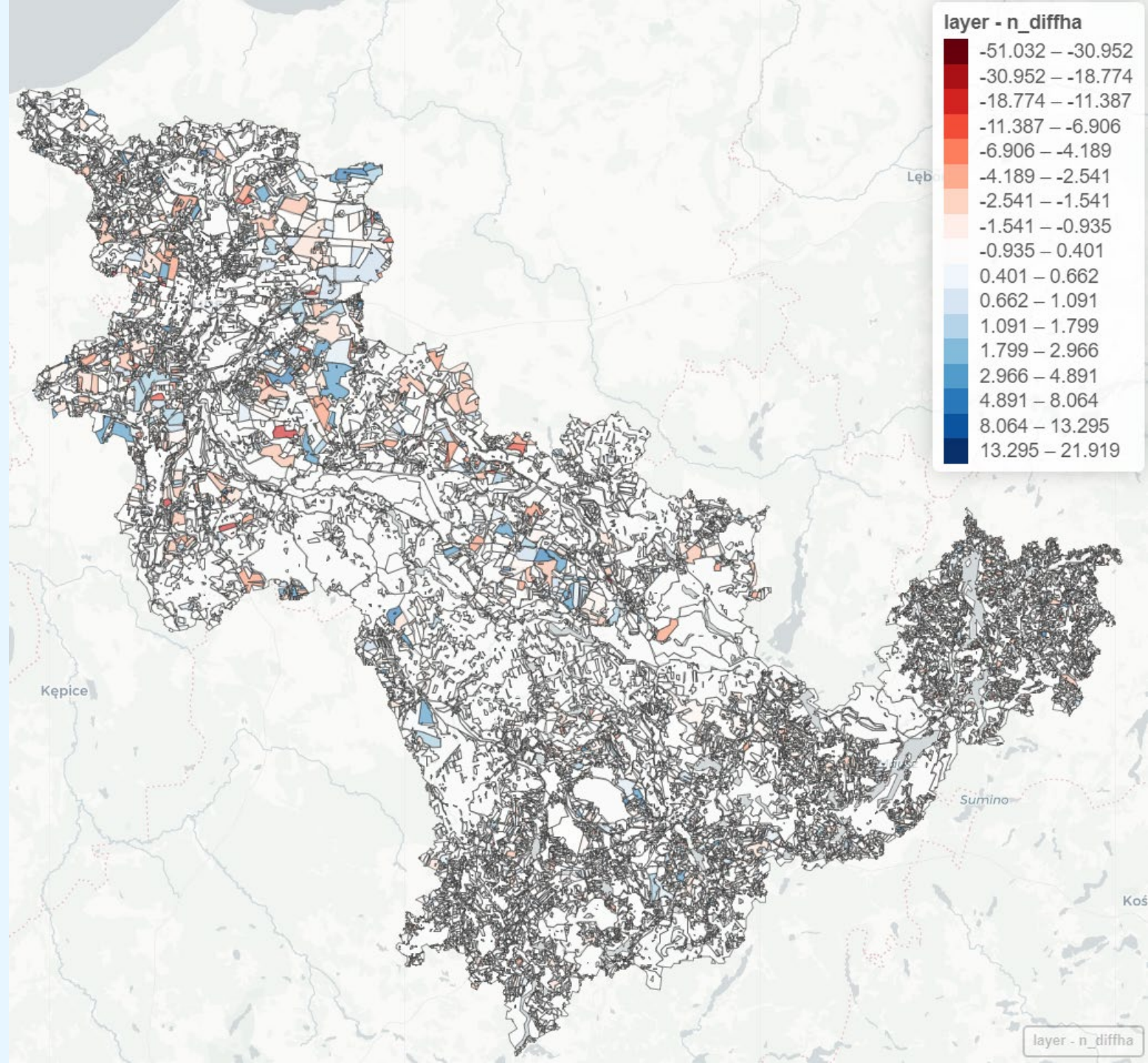
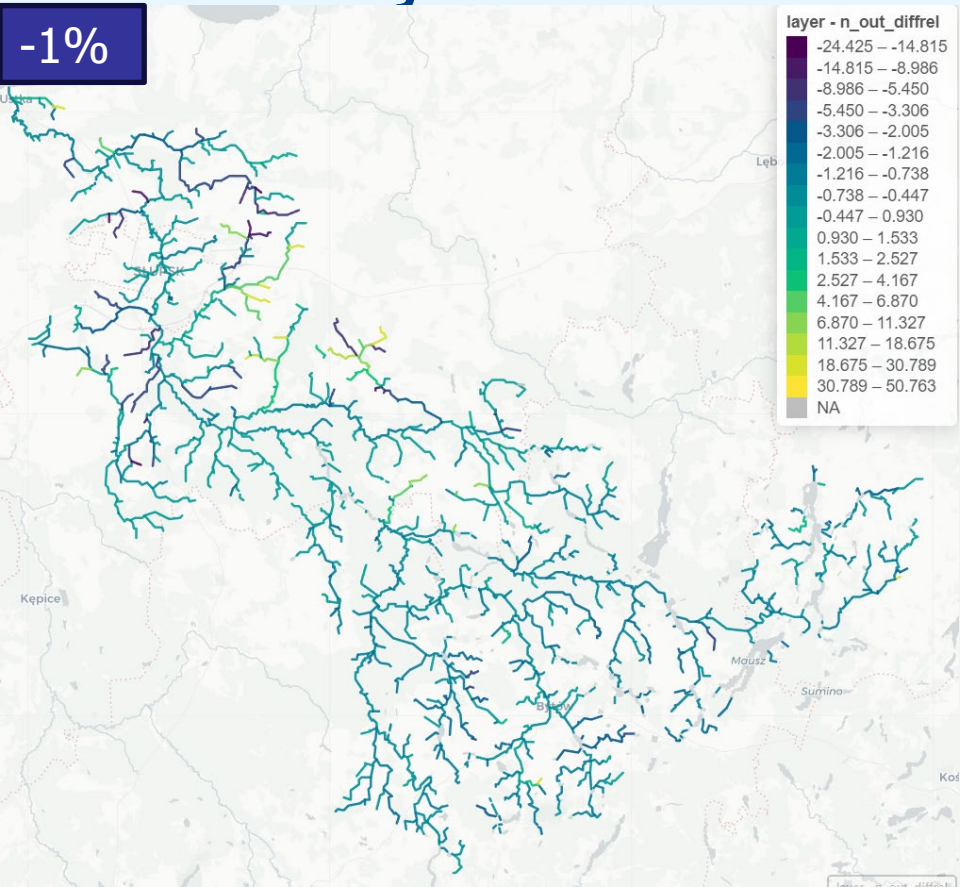

S4: Założenia

- › **Redukcja nawożenia azotem, fosforem oraz nawozami naturalnymi o 20% na wszystkich polach**
- › **Scenariusz z rodzaju: Co by było gdyby?**

S4 (nawożenie): Wyniki

› Zmiana sumarycznych strat azotu z pól (kg/ha)

› Zmiana procentowa
średniego ładunku TN w

-5%

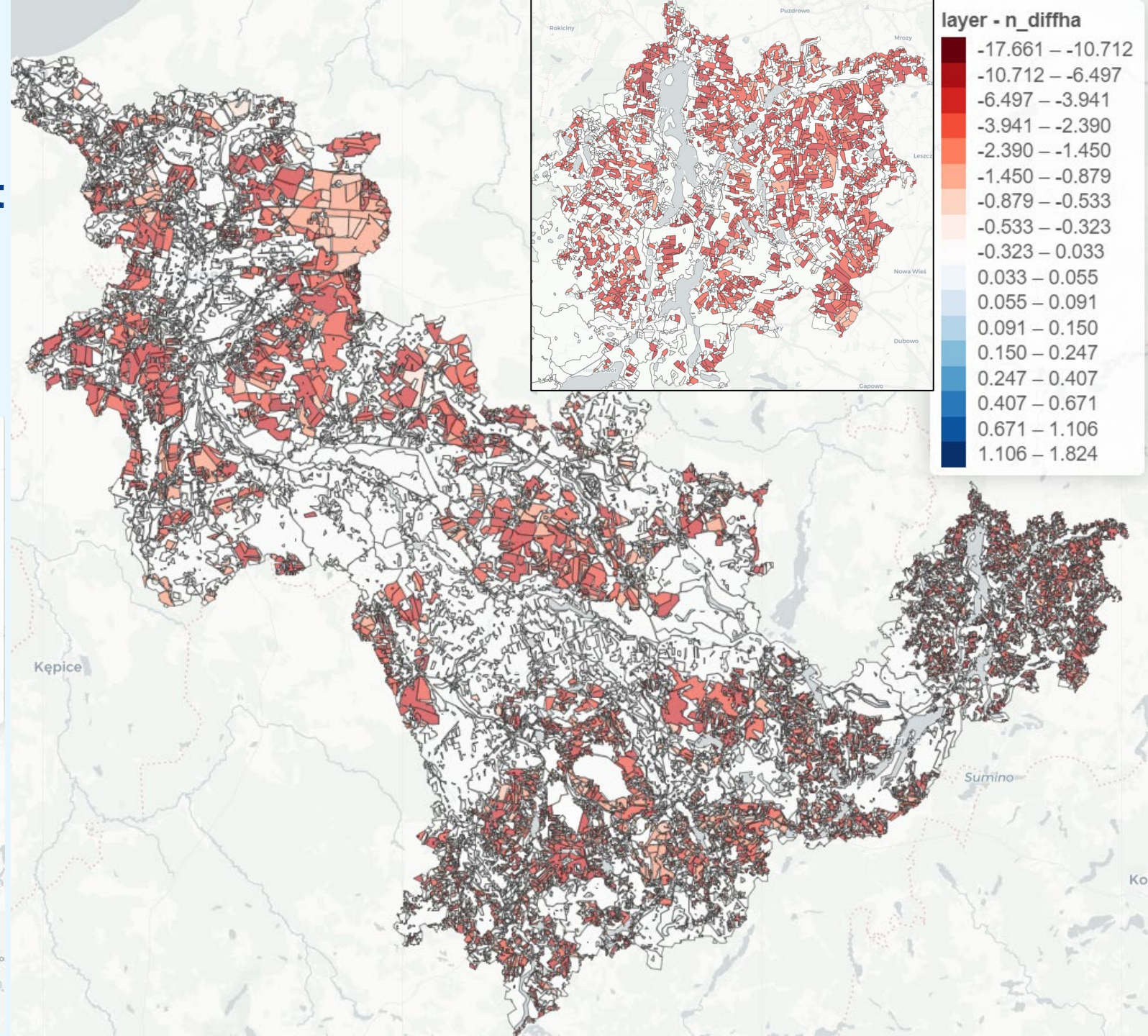
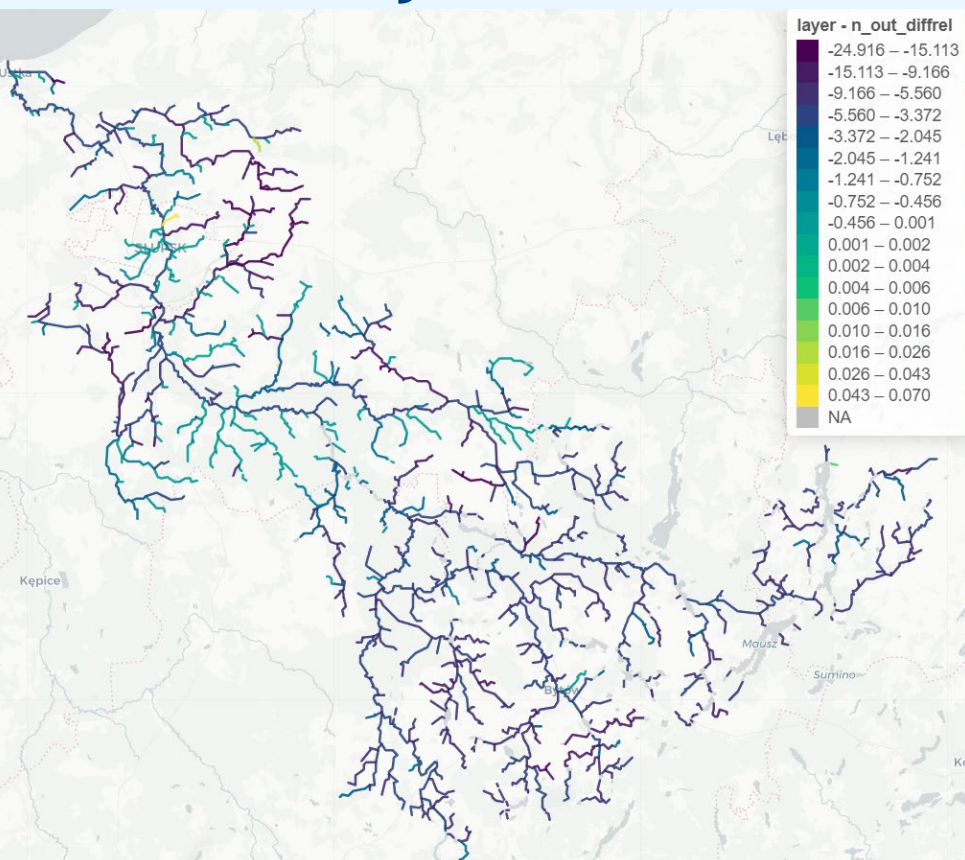

S5: Założenia

- › Zmiana pokrycia oraz użytkowania terenu intensywnego (grunty orne) na ekstensywne (użytki zielone)
- › Lokalizacja działań wybrana w drodze analizy GIS (preferowane pola w pobliżu wód powierzchniowych)
- › W modelu: zmiana parametrów pokrycia terenu (m.in. Erozyjność, współczynnik szorstkości)

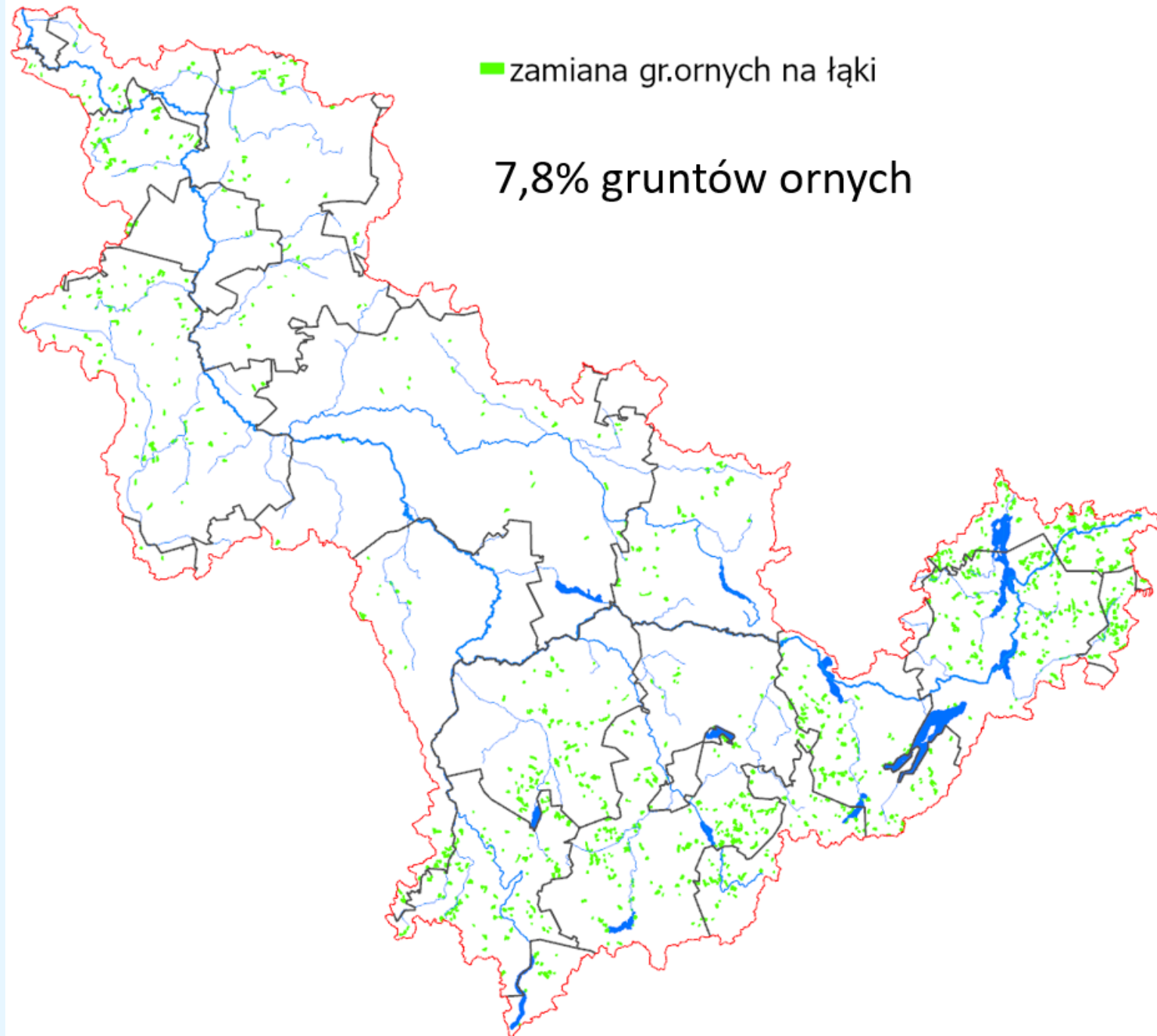

S5 (łąki): Wyniki

- › Zmiana sumarycznych strat azotu z pól (kg/ha)
- › Zmiana procentowa średniego ładunku TN w ciekach

-0.1%

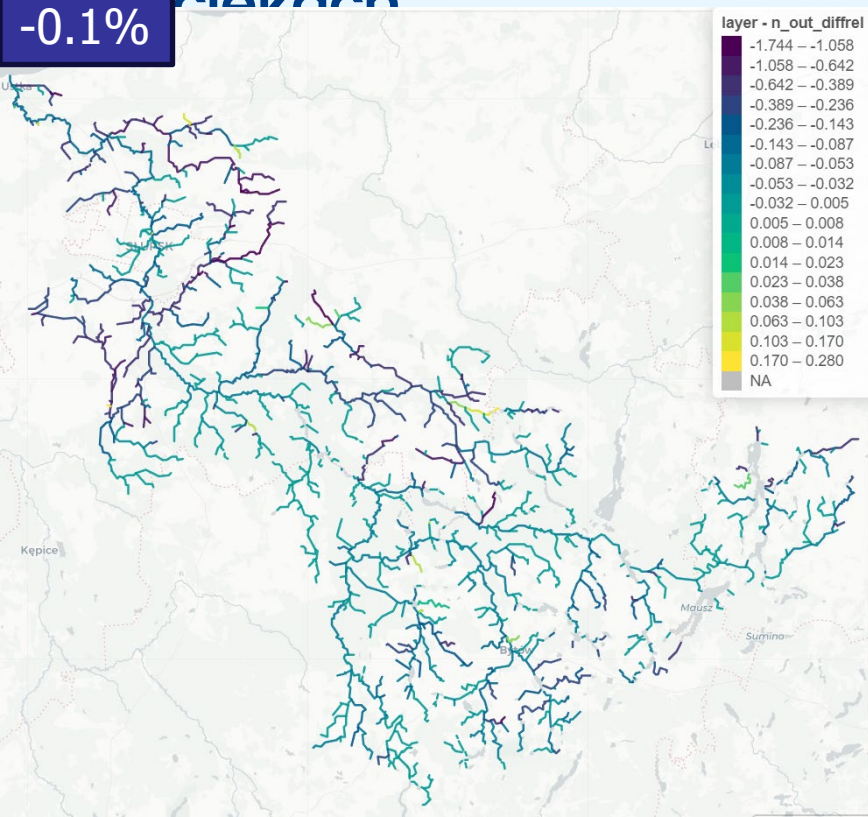

???

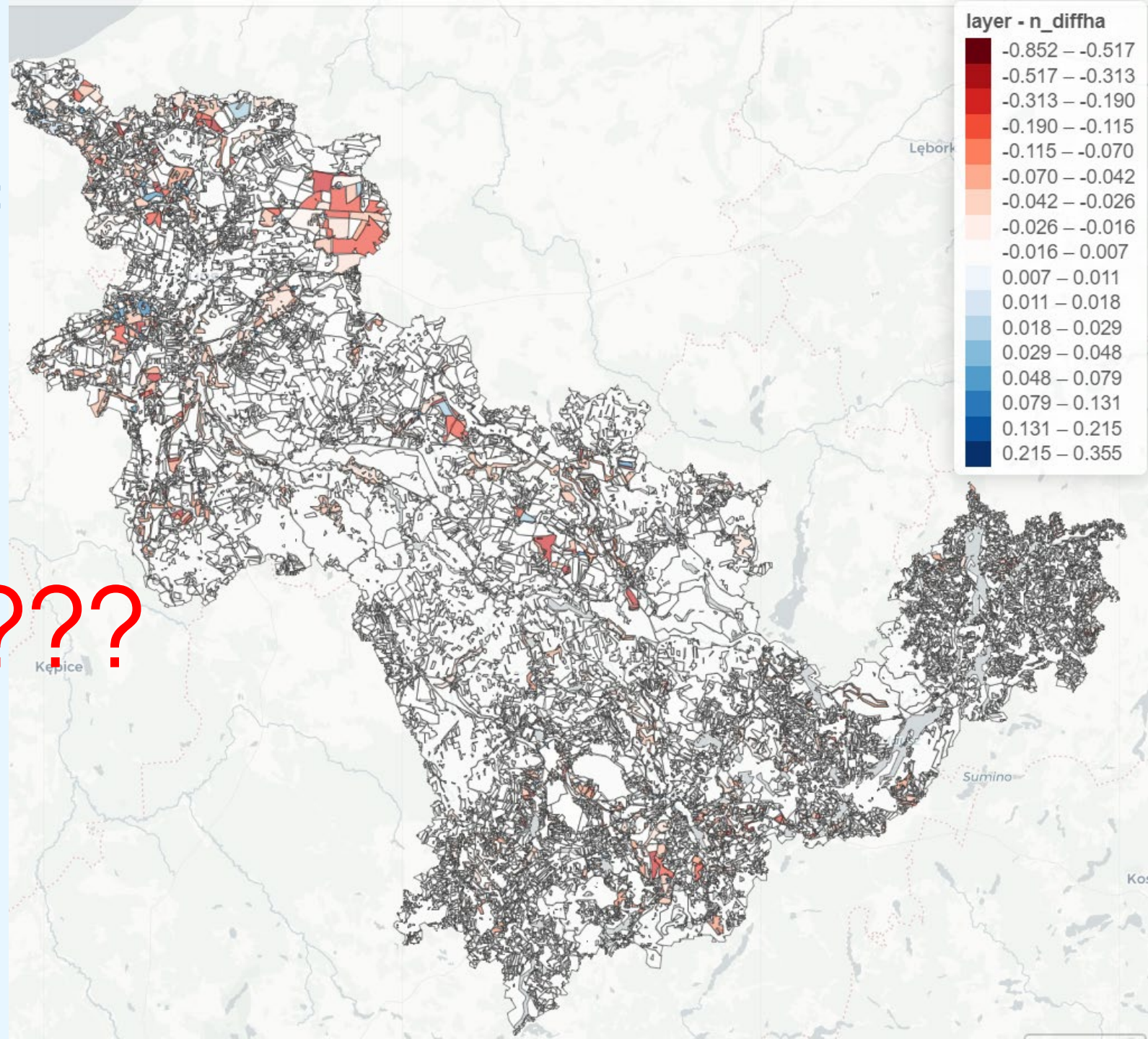

Podsumowanie

- › Ze wstępnych rezultatów wynika że modernizacja oczyszczalni i redukcja nawożenia dają największy efekt w postaci redukcji ładunków azotu na ujściu do Bałtyku (4-5%)
- › Efektywność lokalna (w skali pola, najbliższego cieku) działań wysoce przewyższa efektywność na ujściu
- › Koszty i inne bariery do wdrażania działań
- › Wyniki przydatne w kolejnej aktualizacji planów gospodarowania wodami w dorzeczu (aPGW, 2026)

Diskusja

WP6 policy and governance: evidence from the Nordic and Baltic countries



Lithuania's example

“Key trends in nitrogen and phosphorus loads to surface waters”

Svajunas Plunge

Assistant professor, Szkoła Główna Gospodarstwa Wiejskiego

Contact: svajunas_plunge@sggw.edu.pl



HELCOM subbasins

Nutrient input ceiling for each country and subbasin



Evaluation of input ceilings fulfilment

Nitrogen

Phosphorus

Country/basin	BOB	BOS	BAP	GUF	GUR	DS	KAT	Country/basin	BOB	BOS	BAP	GUF	GUR	DS	KAT
Denmark	↓	↓	↓	↓	↓	↓	↓	Denmark			↓			↓	↓
Estonia	↓	↓	↓	↓	↑	↓	↓	Estonia			↓	↓	↓		
Finland	↓	↓	↓	↓	↓	↓	↓	Finland	↓			↓			
Germany	↓	↓	↓	↓	↓	↓	↓	Germany						↓	
Latvia	↓	↓	↓	↓	↓	↓	↓	Latvia							
Lithuania	↓	↓	↓	↓	↓	↓	↓	Lithuania			↓		↓		
Poland	↓	↓	↓	↓	↓	↓	↓	Poland			↓				
Russia	↓	↓	↓	↓	↓	↓	↓	Russia			↓	↓	↓		
Sweden	↓	↓	↓	↓	↓	↓	↓	Sweden	↓	↓	↓			↓	
Belarus			↓		↓			Belarus			↓		↓		
Czech Republic			↓					Czech Republic			↓				
Ukraine			↓					Ukraine			↓				
Baltic Sea shipping	↓	↓	↓	↓	↓	↓	↓	Baltic Sea shipping			↓				
North Sea Shipping	↓	↓	↓	↓	↓	↓	↓	North Sea shipping			↓				
Other countries	↓	↓	↓	↓	↓	↓	↓	Other countries			↓				

Loads to Baltic Sea

Nitrogen

Phosphorus

BAP

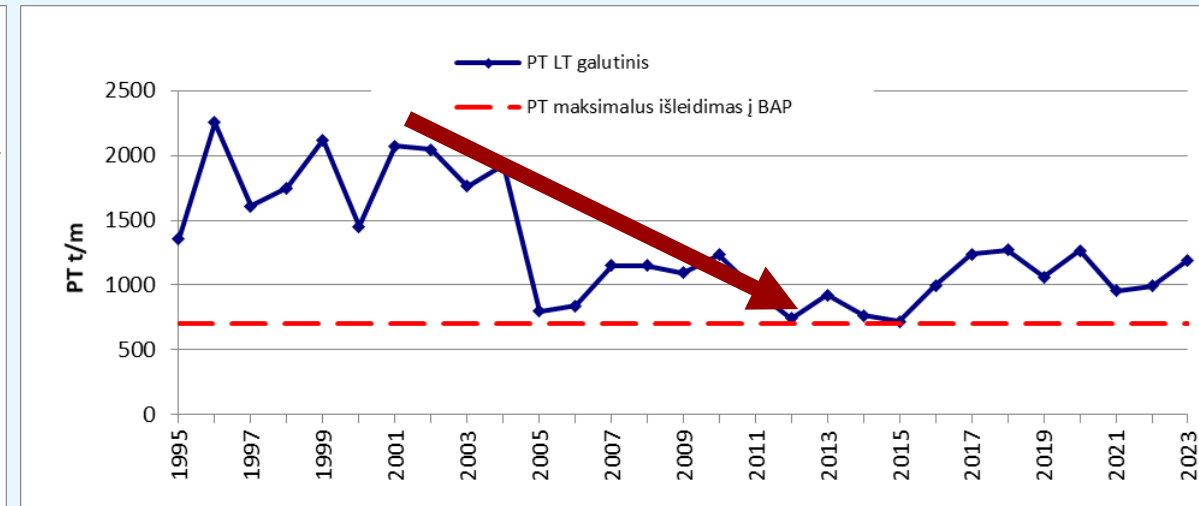
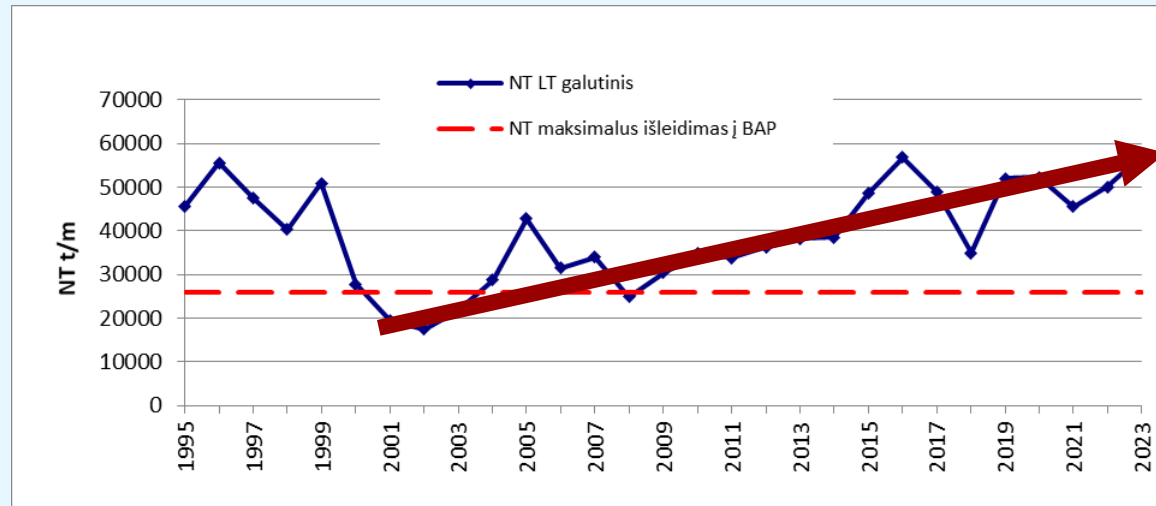

GUR

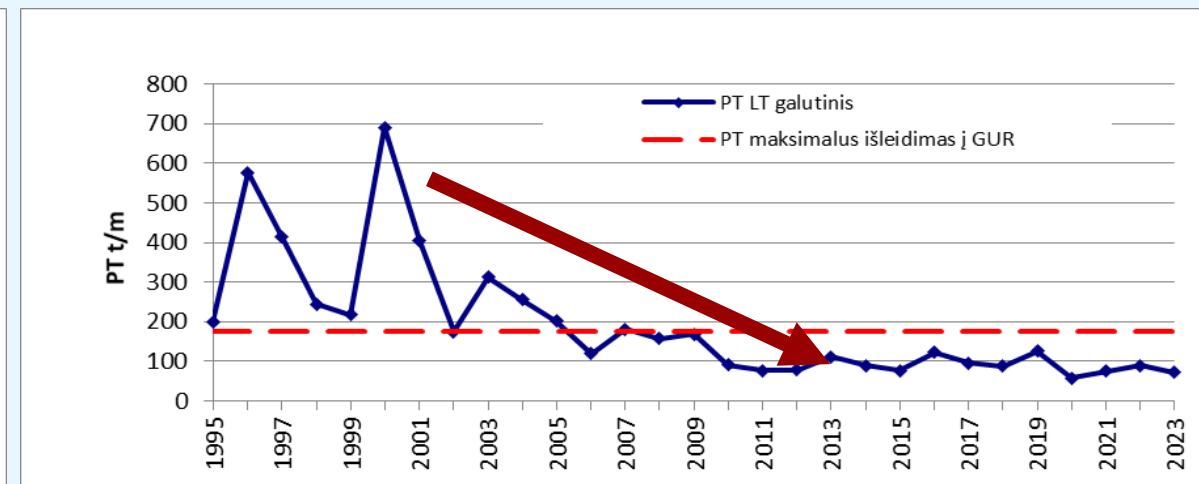
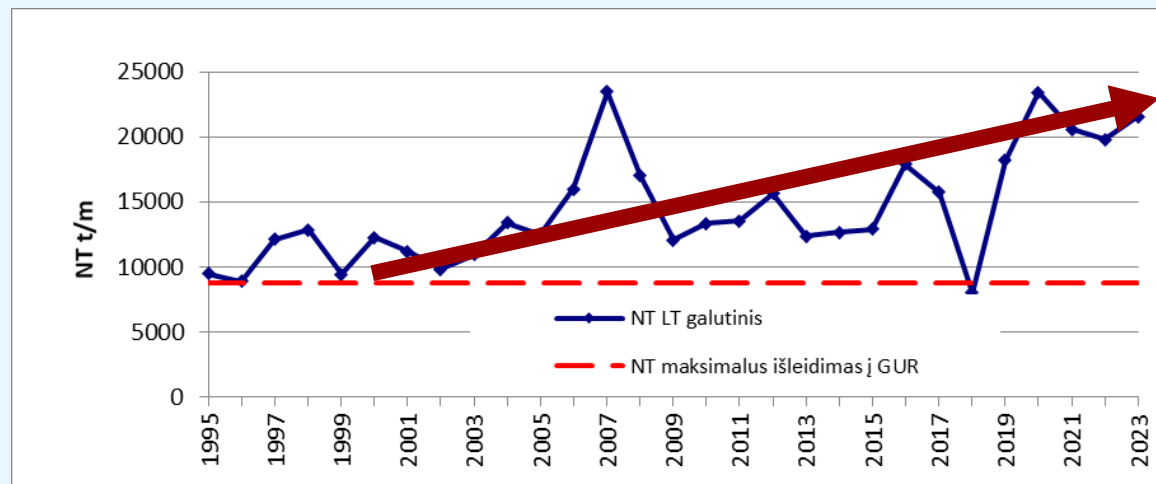

Point source loads (2002-2019)

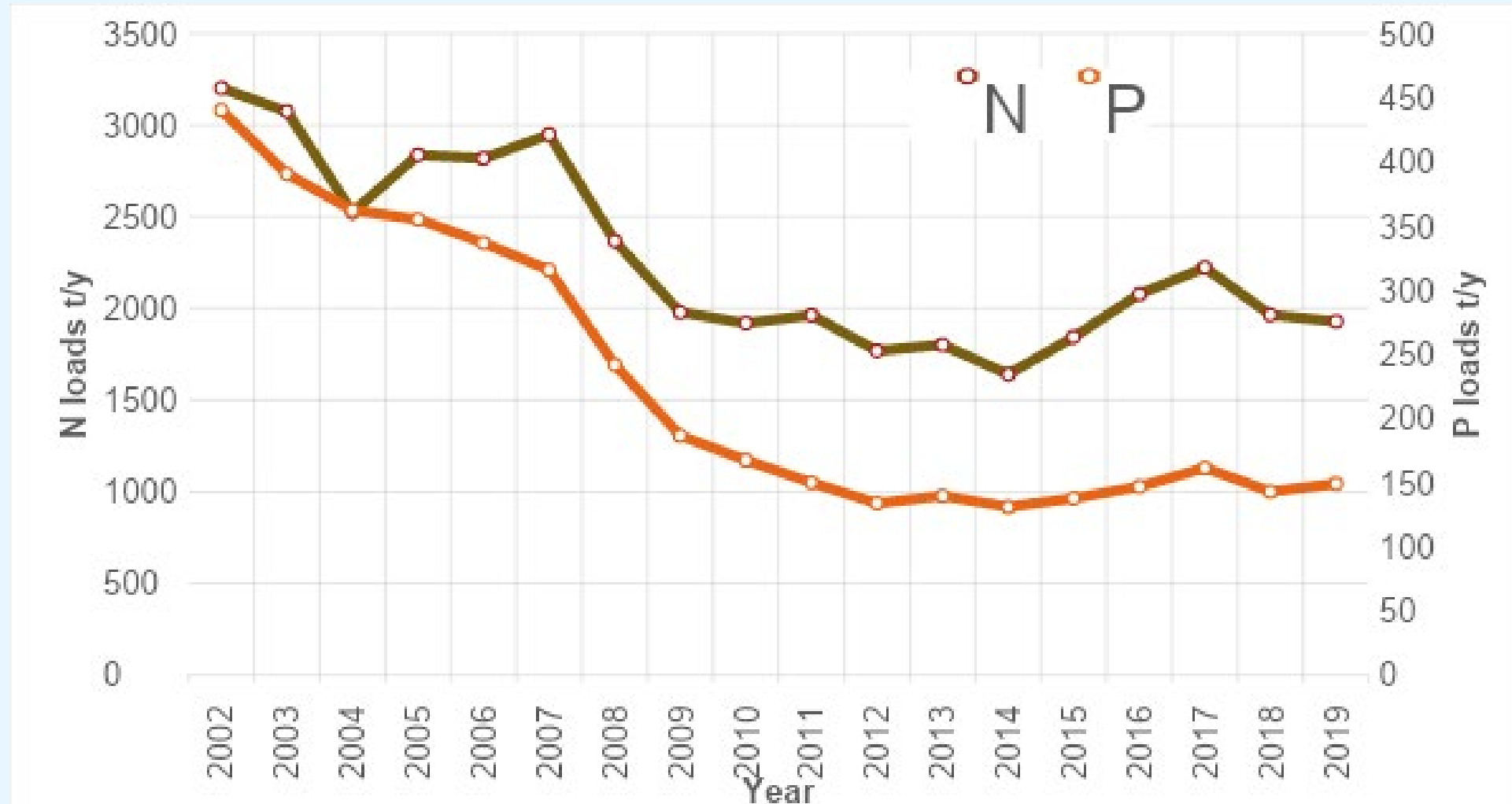

Increase in use of mineral nitrogen fertilizer (1995-2021)

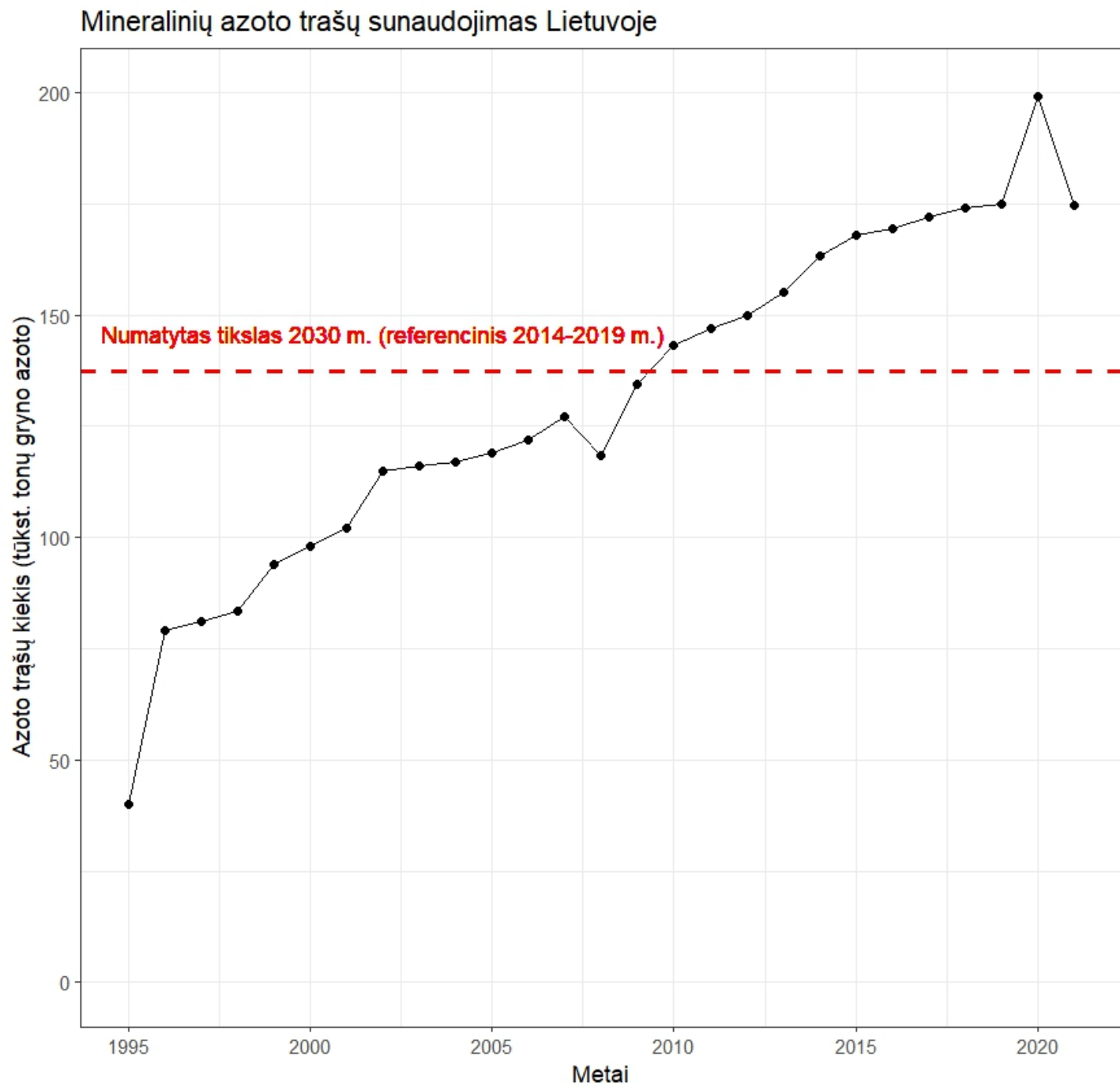

Areas of
↑ grain
production &
↓ grasslands
(2004–2023)

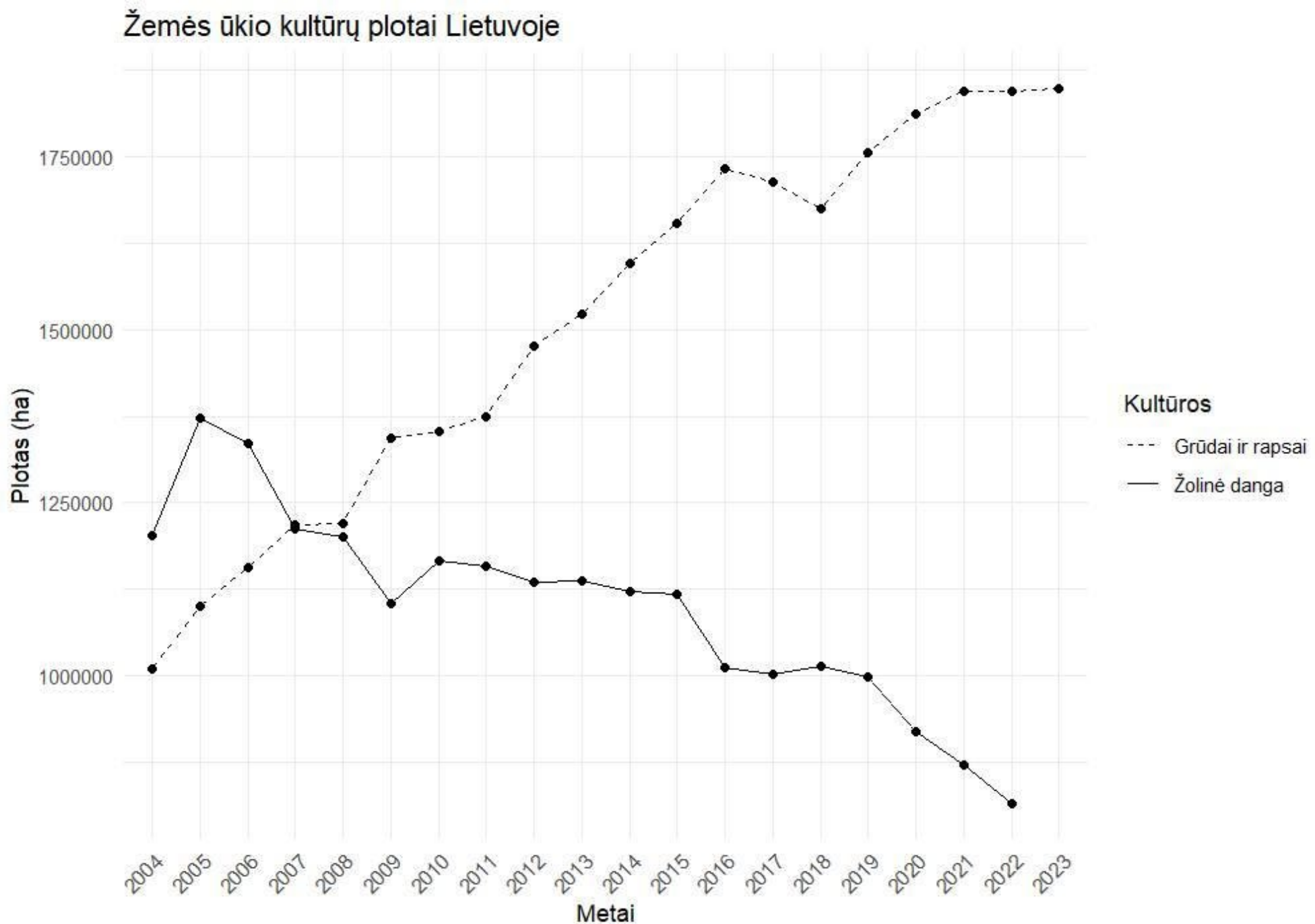

Šaltinis: Valstybės duomenų agentūra



Some problems convincing

measures under CAP program

- *Stubble fields*
- *Winter cover crops*
- *No till*

2020 m. 8%
2023 m.

42%

Tarpinių augalų ir ražienų plotai Lietuvoje 2020-2024 m.

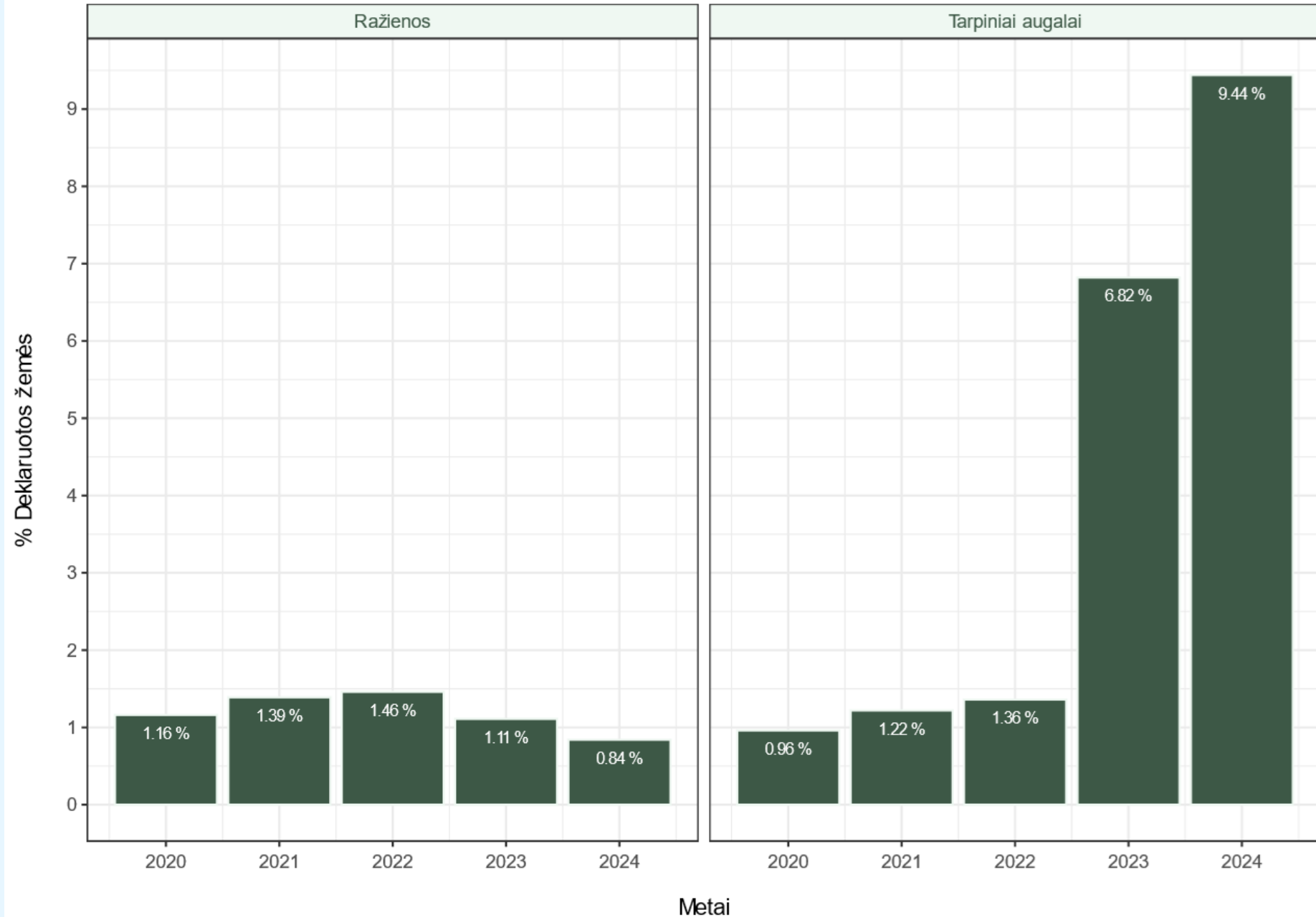

Methodology

- SWAT model available at Lithuanian EPA
- Extended for climate scenarios
 - 7 RCMs models (EURO-CORDEX EUR-11)
 - 2 RCPs (RCP4.5, RCP8.5)
 - 3 20-year periods (historical, mid-century, end-century)
- Extended for BMPs
 - 5 selected + no-BMP
 - Max-area application
 - One at the time
- Genetic algorithm
 - Optimization of 4 axes (N&P reduction, costs and yield loss minimization)
 - 7x2x6 = 84 different scenarios input
 - Targets from WFD + BSAP
- Quality assurance
 - R scripting
 - Framework into scripted workflow

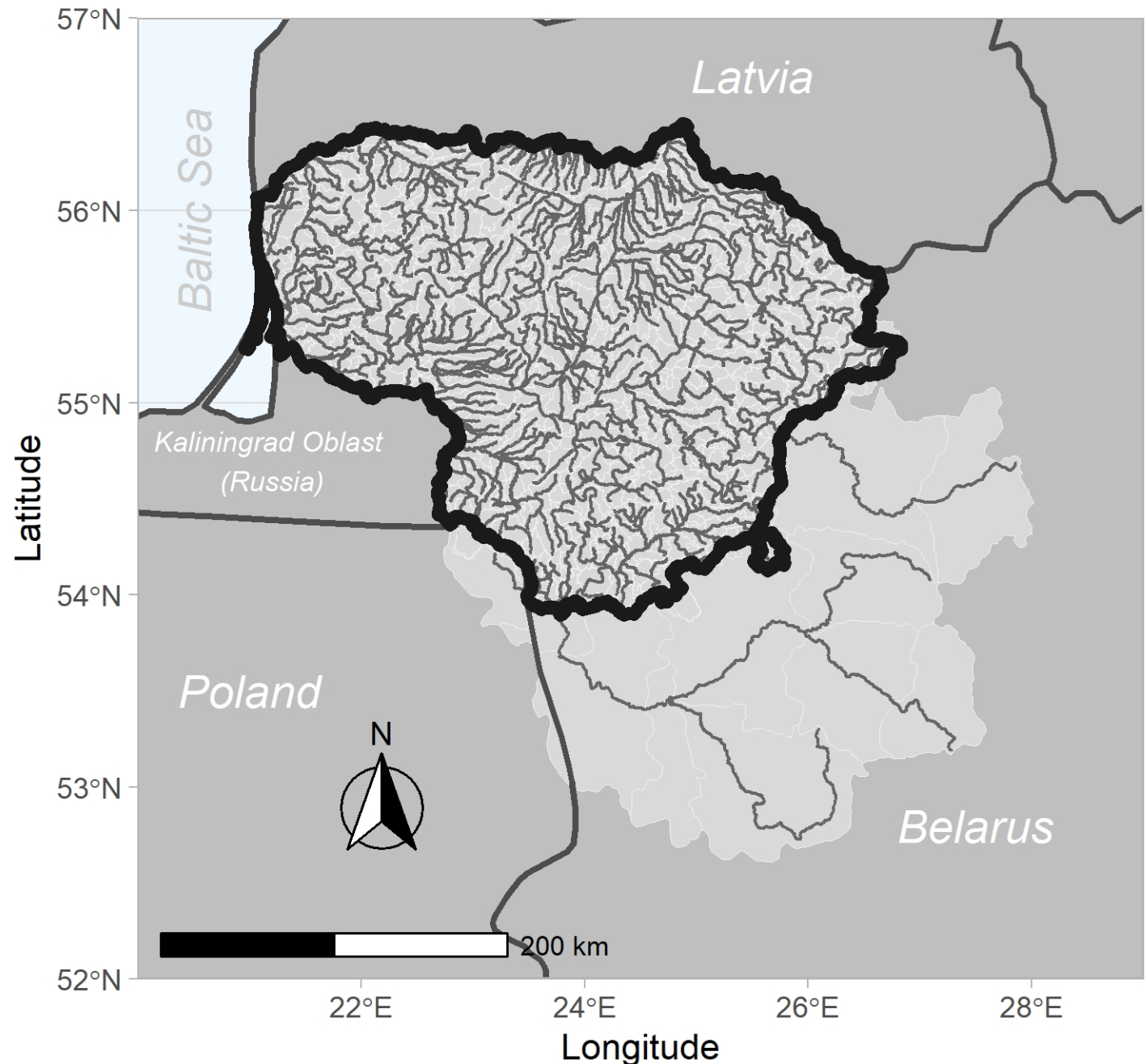

Climate change impact in Lithuania (flows)

RCP4.5 to RCP8.5 end-century

- Precipitation \uparrow 5.7% to 17.9%
- Snow melt \downarrow $\frac{1}{3}$ to $\frac{2}{3}$
- Surface runoff decrease \downarrow 17.9% to 15.9%
- Water flows \uparrow 9.6% to 35.4%

Plunge, S., Gudas, M., Povilaitis, A., 2022. Expected climate change impacts on surface water bodies in Lithuania. *Ecohydrol Hydrobiology* 22, 246–268.

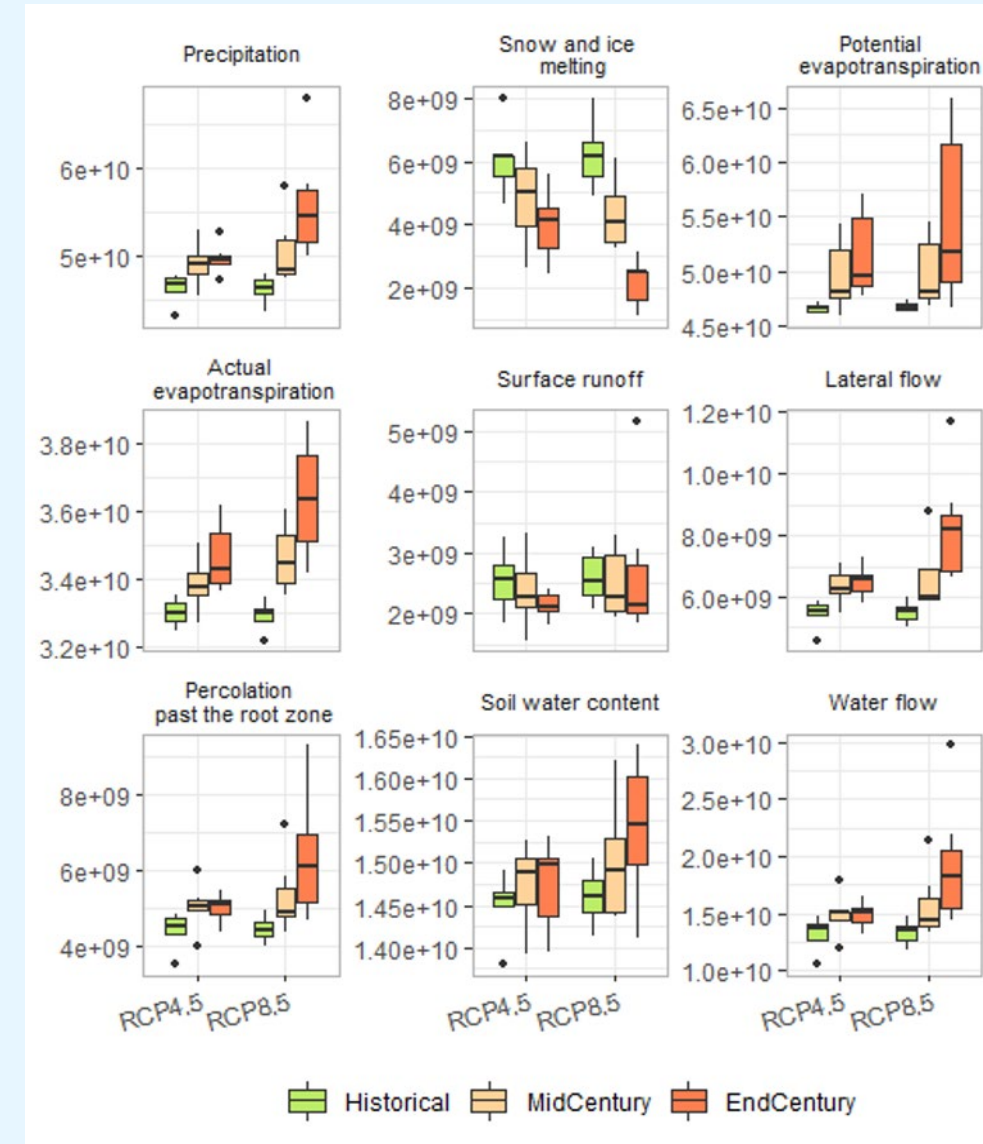

Climate change impact in Lithuania (nutrient loads)

RCP8.5 end-century

- Sed ↓ 13.3%, N_{org} ↓ 22.4%,
- P_{org} ↓ 15.3%, P_{min} ↓ 6.3%
- Nitrates
 - Tile drains ↑ 153.1%
 - Lateral flow ↑ 57.2%
 - Groundwater flow ↑ 108.7%

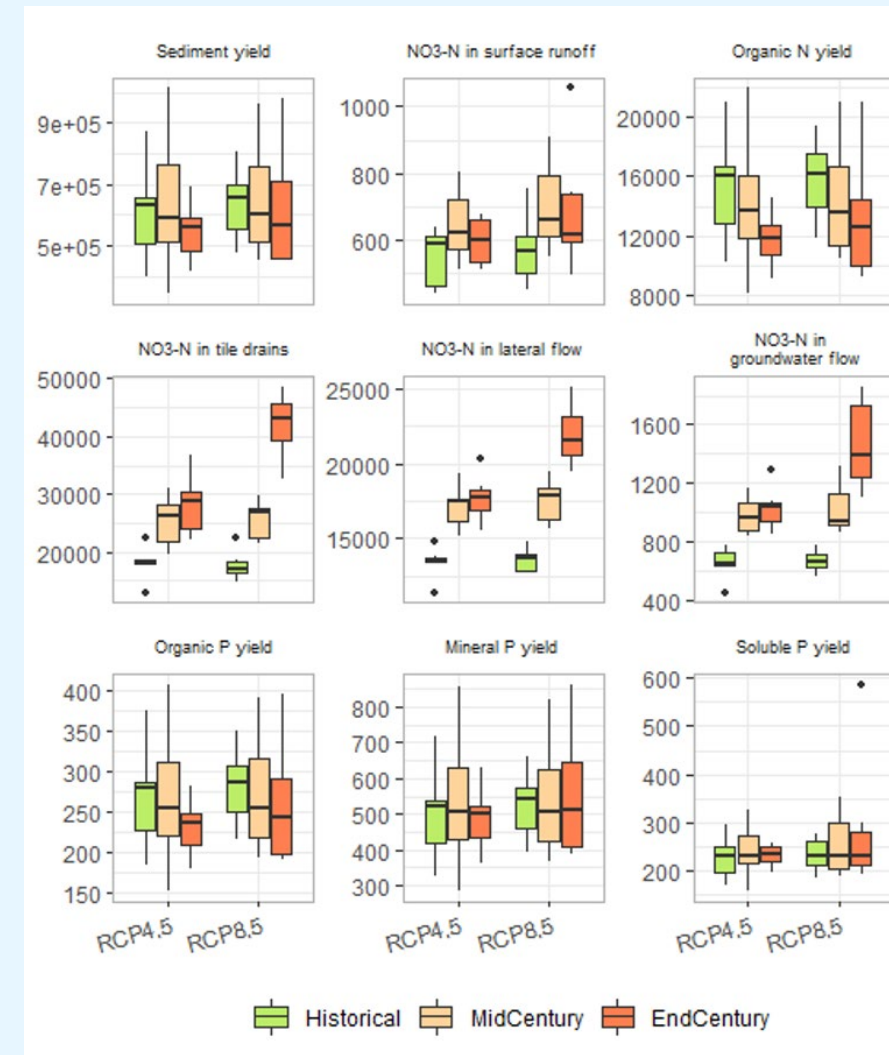

Plunge, S., Gudas, M., Povilaitis, A., 2022. Expected climate change impacts on surface water bodies in Lithuania. *Ecohydrol Hydrobiology* 22, 246–268.

Climate change impact BMPs effectiveness (potential)

RCP8.5 end-century

- *Grassland+* ↑ 17% TN
- *Fertilization-* ↑ 179% TN 226% TP
- *No-plough* ↓ 50% TN 30% TP
- *WintCrops* ↓ 12% TN 11% TP
- *StubbleFields* ↓ 26% TN 17% TP

Plunge, S., Gudas, M., Povilaitis, A., 2022. Effectiveness of best management practices for non-point source agricultural water pollution control with changing climate – Lithuania’s case. *Agr Water Manage* 267, 107635.

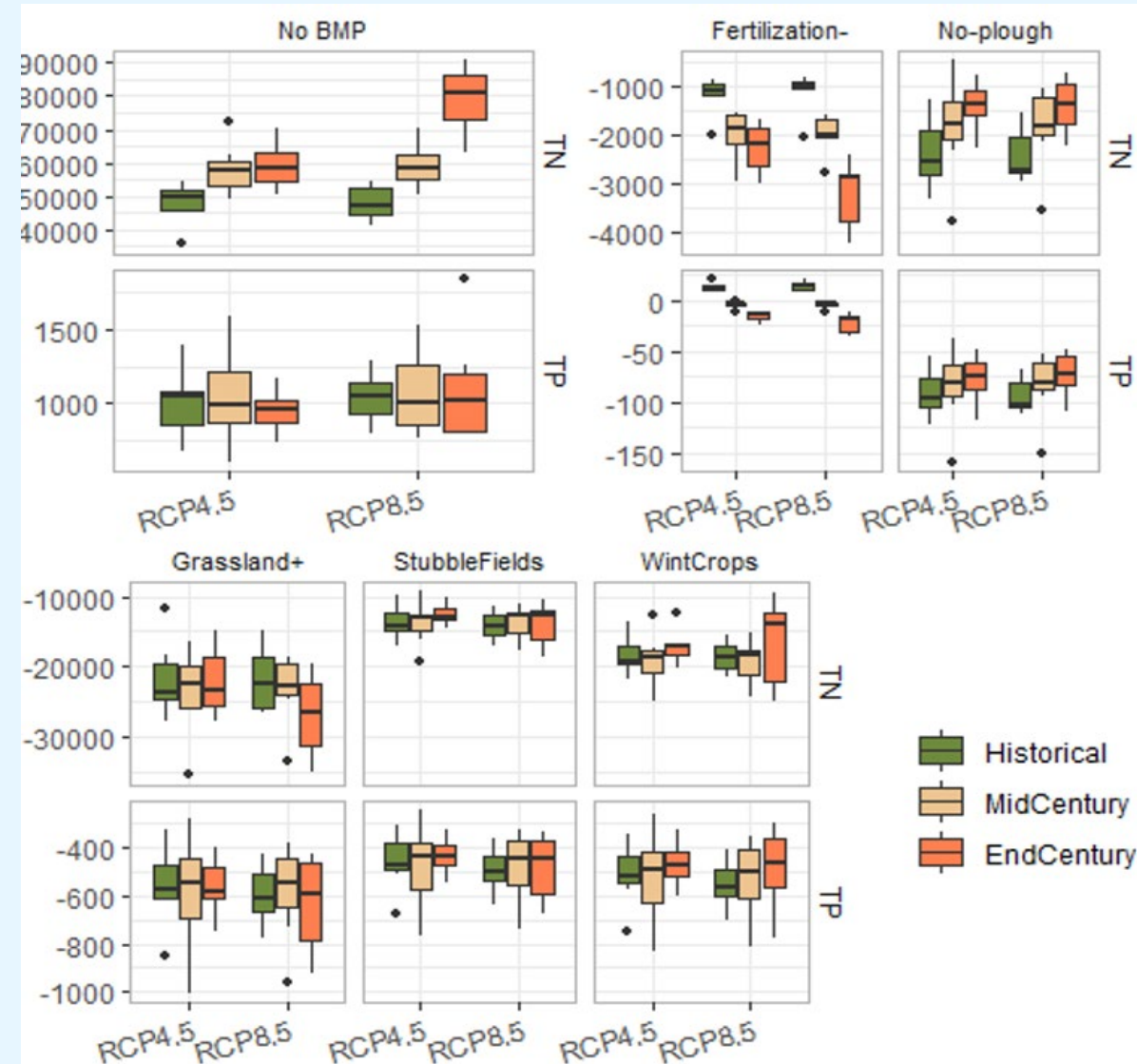

Reaching water protection targets (BMPs on 4 axes)

RCP8.5 end-century

- TN loads reduced 4x more with *Grasslands+*, 1/2 with *WintCrops*
- Costs 220% ↑ , 175% ↑ for RCP4.5

Plunge, S., Gudas, M., Povilaitis, A., Piniewski, M., 2023. Evaluation of the costs of agricultural diffuse water pollution abatement in the context of Lithuania's water protection goals and climate change. *Environ Manage* 71, 755–772.

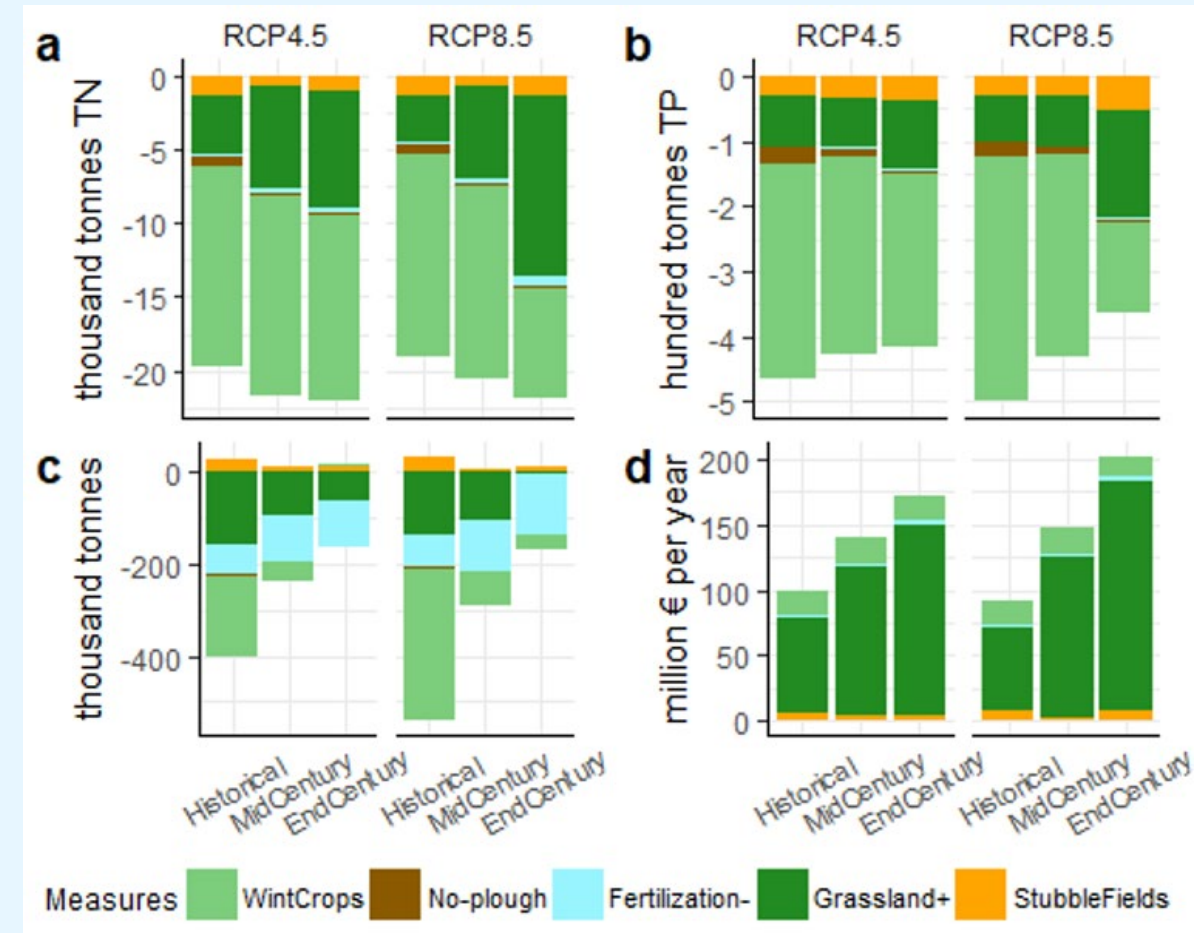

Reaching water protection targets (targeting)

- Dominant action from median optimization results
- Agriculture dominated areas
- No-plough only in the North and South-West and current conditions
- Primary *WintCrops*
- Changed to *Grassland+*, other areas to extensive agriculture

Plunge, S., Gudas, M., Povilaitis, A., Piniewski, M., 2023. Evaluation of the costs of agricultural diffuse water pollution abatement in the context of Lithuania's water protection goals and climate change. *Environ Manage* 71, 755–772.

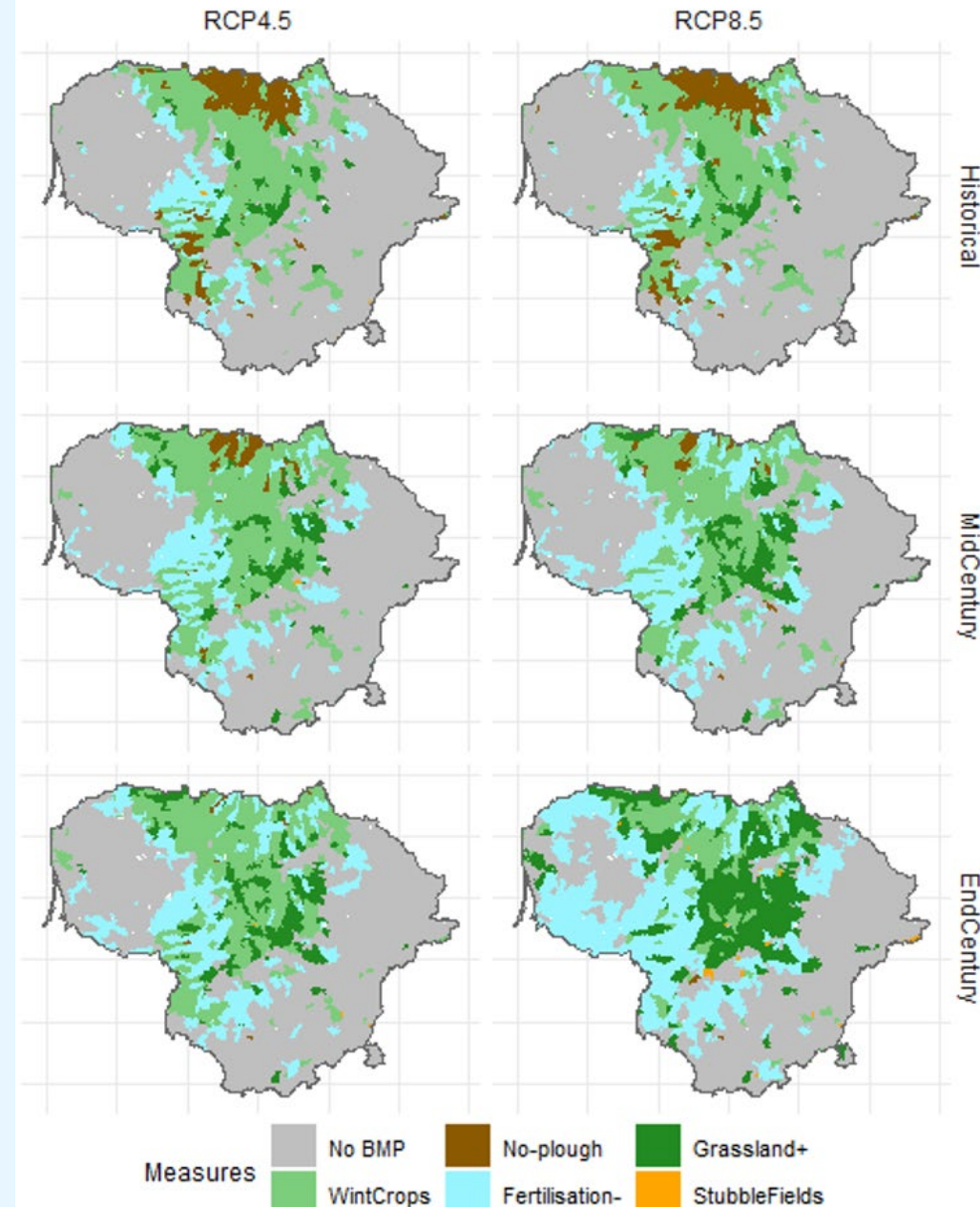

Final notes

- › **EU CAP policies and water protection efforts often work at cross purposes.**
- › **Clear benefits have been observed from investments in wastewater collection and treatment.**
- › **There is a lack of political will to shift away from the intensive grain production model.**
- › **Climate change significantly hinders progress toward achieving environmental goals.**